

# VERTILINE

## **VertiLine 33DV/63DV Series** Rack Mount Power Supplies

### **Models Include:**

#### **VertiLine33DV**

- 12VDC @ 8A
- Sixteen (16) PTC protected outputs

#### **VertiLine33TDV**

- 12VDC @ 16A
- Sixteen (16) PTC protected outputs

#### **VertiLine63DV**

- 24VDC @ 8A
- Sixteen (16) PTC protected outputs

#### **VertiLine63TDV**

- 24VDC @ 16A
- Sixteen (16) PTC protected outputs

## **Installation Guide**



Rev. 090810

**More than just power.™**

Installing Company: \_\_\_\_\_ Service Rep. Name: \_\_\_\_\_

Address: \_\_\_\_\_ Phone #: \_\_\_\_\_

## Overview:

Altronix VertiLine Rack Mount Power Supplies provide sixteen (16) filtered and electronically regulated power outputs in a space saving 1U EIA 19" rack mount chassis. The units are available with either 12VDC or 24VDC power outputs. VertiLine Rack Mount Power Supplies are also available with eight (8) outputs.

## Specifications:

### Agency Listing:

- CE European Conformity.

### Input:

- 220VAC 50/60Hz.

### Output:

- Filtered and electronically regulated outputs.

### VertiLine33DV, VertiLine33TDV:

- Sixteen (16) PTC protected 12VDC power outputs.

### VertiLine63DV, VertiLine63TDV:

- Sixteen (16) PTC protected 24VDC power outputs.

### Features:

- Sixteen (16) power LED indicators.
- Illuminated master power disconnect circuit breaker with manual reset.
- IEC 320 - 3-wire grounded line cord (detachable).
- Removable terminal blocks with locking screw flange.

### Mechanical:

- Units can be rack, wall or shelf mounted.
- Modular 1U standard EIA 19" rack mount chassis.
- Enclosure Dimensions (H x W x D approx.):  
1.625" x 19.125" x 8.5"  
(41.3mm x 486mm x 216mm).

## Sixteen (16) Output Rack Mount Configuration Reference Chart:

Altronix Model Number	Output Voltage	Total Output Current (Power)	Number of Outputs	Output Protection	Current (max. per output)	220VAC 50/60 Hz Input Current
VertiLine33DV	12VDC	8A	16	PTC	2.5A	0.75A
VertiLine33TDV	12VDC	16A	16	PTC	2.5A	1.5A
VertiLine63DV	24VDC	8A	16	PTC	2.5A	1.5A
VertiLine63TDV	24VDC	16A	16	PTC	2.5A	3A

**WARNING:** To reduce the risk of fire or electric shock, do not expose the unit to rain or moisture. This installation should be made by qualified service personnel and should conform to the National Electrical Code and all local codes.

## Installation Instructions:

1. Attach mounting brackets to VertiLine unit for rack or wall mount installation (*Figs. 4-5, pg. 7*). Affix rubber pads to VertiLine for shelf installation (*Fig. 6, pg. 7*).
2. Secure the unit into rack, mount unit to a wall or place unit on a shelf as desired (unit should be spaced at least 3" from any video monitors). When installing the unit in a rack allow for one half U spacing above the unit for ventilation.
3. Insert and secure removable terminal blocks to unit (*Fig. 1e, pg. 4*).
4. Plug the grounded AC line cord (included) into the IEC 320 connector of the VertiLine unit (*Fig. 1d, pg. 4*). Insert the plug end of the line cord into a grounded AC receptacle.
5. Set illuminated master power disconnect circuit breaker to the (ON) position (*Fig. 1c, pg. 4*).
6. Measure output voltage before connecting cameras/devices. This helps avoiding potential damage.
7. Set illuminated master power disconnect circuit breaker to the (OFF) position (*Fig. 1c, pg. 4*).
8. Connect the power output of terminals marked [+ 1 -] to the power input of device (*Fig. 1b, pg. 4*). Repeat this step for each additional device (Outputs 2-16).
9. Upon completion of wiring, set illuminated master power disconnect circuit breaker to the ON (RESET) position (*Fig. 1c, pg. 4*).
10. The power LEDs on the faceplate for Outputs 1-8 will illuminate when AC power is present (*Fig. 1a, pg. 4*).

**Note:** If any of the power LEDs are not illuminated, the cause may be due to the following:

- a. AC mains fail.
- b. Illuminated master power disconnect circuit breaker is OFF or tripped.
- c. One (1) or more power output PTCs are tripped due to a short circuit or overload condition.  
To reset the PTC:
  1. Set illuminated master power disconnect circuit breaker to the (OFF) position (*Fig. 1c, pg. 4*).
  2. Eliminate the trouble condition (short circuit or overload).
  3. Allow 1 minute for PTC to cool off (reset).
  4. Set illuminated master power disconnect circuit breaker to the (ON) position (*Fig. 1c, pg. 4*).
  5. All power LEDs will illuminate indicating power has been restored to all outputs (*Fig. 1a, pg. 4*).

Fig. 1

VertiLine33DV, VertiLine33TDV, VertiLine63DV and VertiLine63TDV (front)

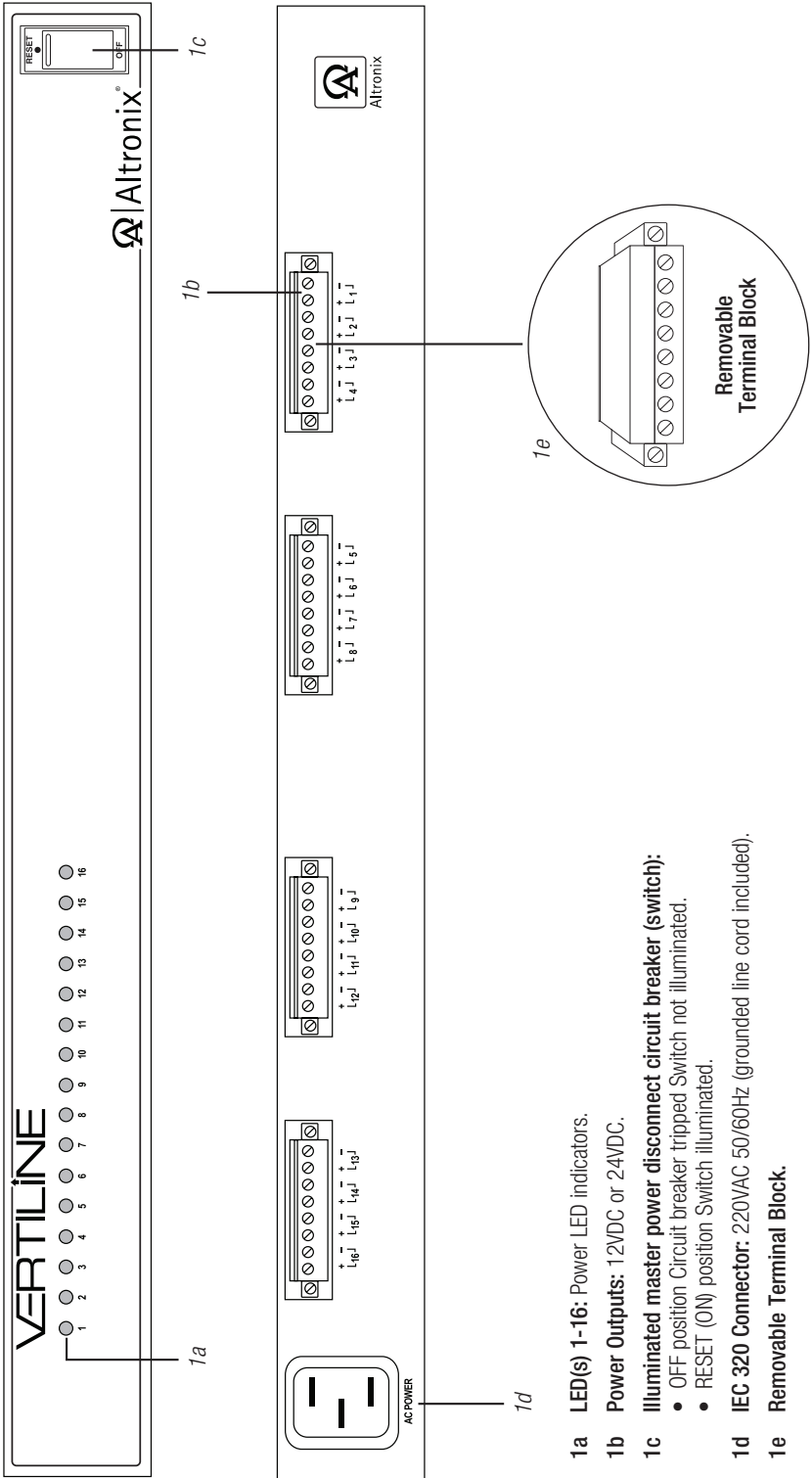

- 1a** LED(s) 1-16: Power LED indicators.
- 1b** Power Outputs: 12VDC or 24VDC.
- 1c** Illuminated master power disconnect circuit breaker (switch):
  - OFF position Circuit breaker tripped Switch not illuminated.
  - RESET (ON) position Switch illuminated.
- 1d** IEC 320 Connector: 220VAC 50/60Hz (grounded line cord included).
- 1e** Removable Terminal Block.

Fig. 2

Typical Application Drawing:

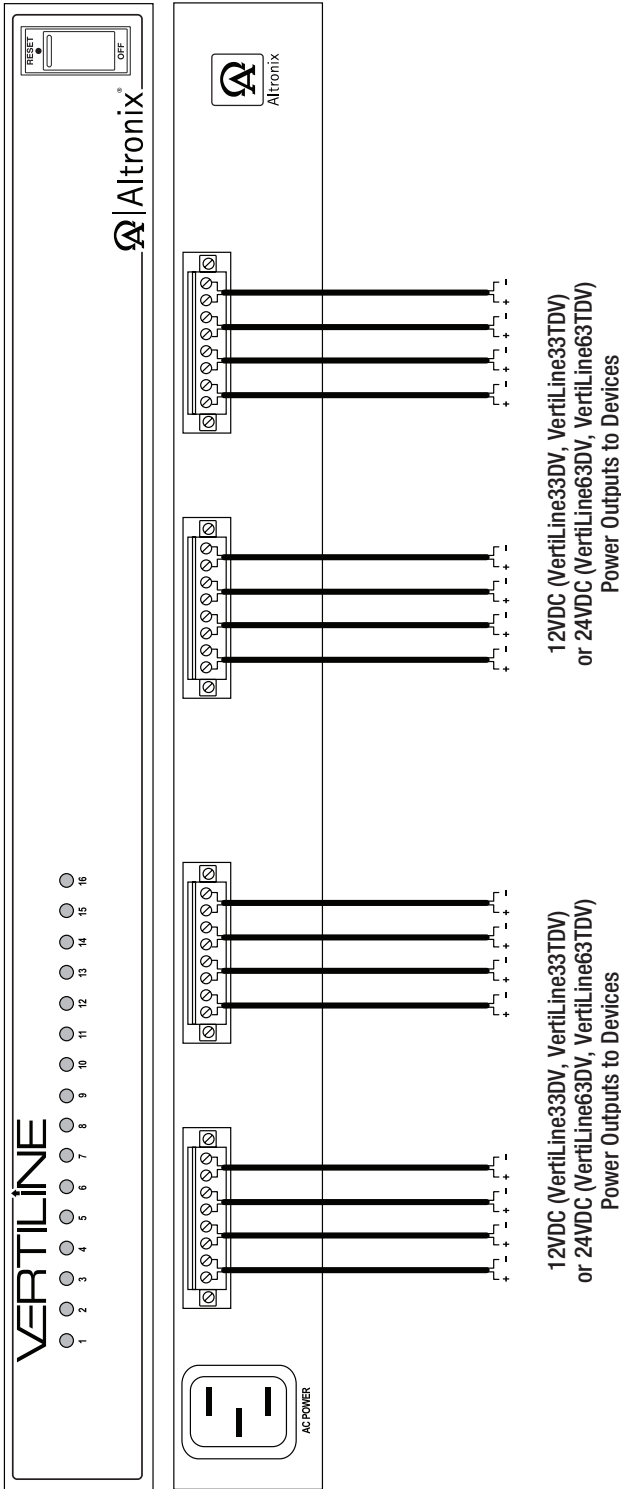



The lightning flash with arrowhead symbol within an equilateral triangle is intended to alert the user to the presence of an insulated **DANGEROUS VOLTAGE** within the product's enclosure that may be of sufficient magnitude to constitute an electric shock.



The exclamation point within an equilateral triangle is intended to alert the user to the presence of important operating and maintenance (servicing) instructions in the literature accompanying the appliance.



**CAUTION**  
RISK OF ELECTRIC SHOCK  
DO NOT OPEN



**CAUTION:** To reduce the risk of electric shock do not open enclosure. There are no user serviceable parts inside. Refer servicing to qualified service personnel.

## 1U EIA 19" Rack Mount Chassis Mechanical Drawing & Dimensions (H x W x D):

1.625" x 19.125" x 8.5" (41.3mm x 486mm x 216mm)

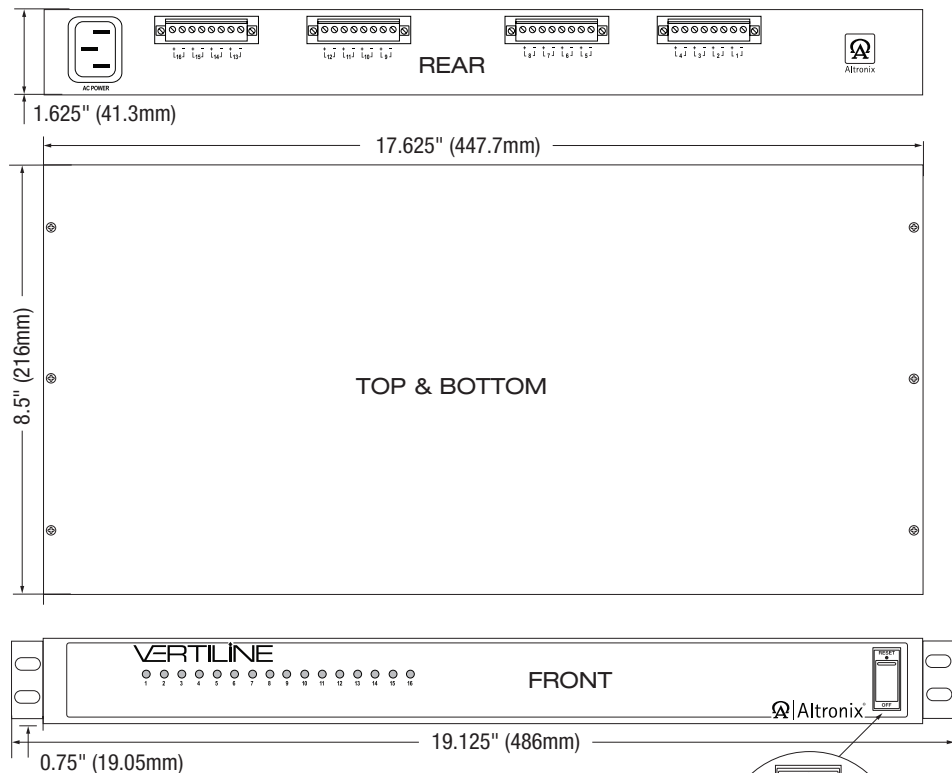

Fig. 3

### Power Switch With Built-In Circuit Breaker:

OFF position - Switch not illuminated. Outputs not powered.

RESET (ON) position - Switch illuminated. Outputs powered.

Circuit breaker tripped - Switch not illuminated.

Power LEDs on faceplate are not illuminated. Outputs not powered.

To reset circuit breaker set power switch to the ON (RESET) position

(Fig. 3, pg. 6).

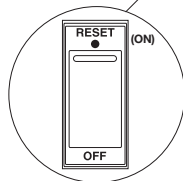

## Mounting Options:

### Rack Mount Installation

1. Remove factory installed screws from both sides of the rack chassis (Fig. 4a).
2. Install mounting brackets (A) on the left and right side of rack chassis using the two (2) flat head screws (B) (included) (Fig. 4b).
3. Place unit into desired EIA 19" rack position and secure with mounting screws (not included) (Fig. 4c).

Fig. 4

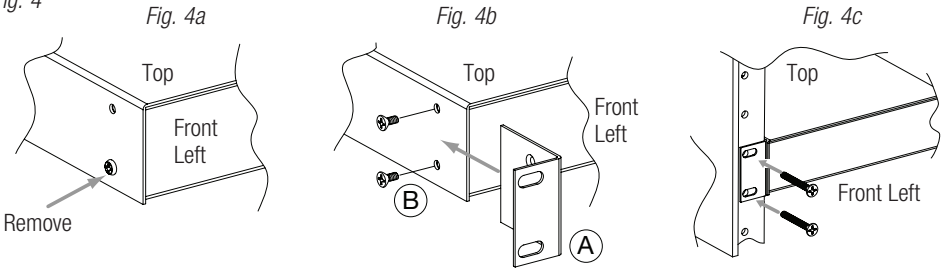

### Wall Mount Installation

1. Install mounting brackets (A) on the left and right side of rack chassis using two (2) flat head screws (B) (included) (Fig. 5a).
  2. Place unit at desired location and secure with mounting screws (not included) (Fig. 5b).
- Caution:** It is necessary to make sure mounting screws are securely fastened to a beam when installing.

Fig. 5

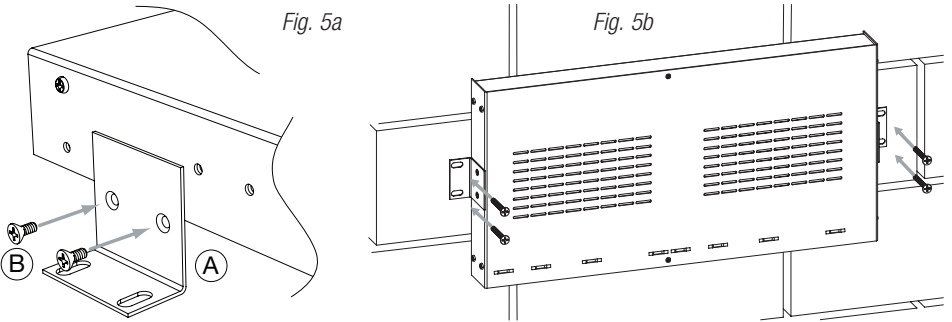

### Shelf Installation

1. Position and affix rubber pads (C) (included) at each corner on the bottom of the unit (Fig. 6).
2. Place unit in desired location.

Fig. 6

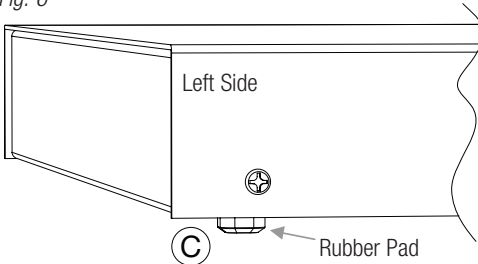

### Mounting Hardware (Included):

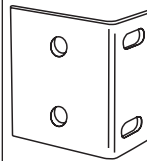

(A) Two (2) mounting brackets



(B) Six (6) flat head screws for mounting brackets.



(C) Four (4) rubber pads.

## Notes:

Altronix is not responsible for any typographical errors.

140 58th Street, Brooklyn, New York 11220 USA | phone: 718-567-8181 | fax: 718-567-9056  
website: [www.altronix.com](http://www.altronix.com) | e-mail: [info@altronix.com](mailto:info@altronix.com) | Lifetime Warranty  
IIVertiLine33DV/63DV Series K04U

