



UNITED BRASS WORKS, INC.
 714 S. Main St. Randleman, N.C. 27317
 Tel: 800-334-3035 Fax: 800-498-4696 www.ubw.com



Model 99T Swing Check Valve

125WSP @ 350° Max
200 WOG
100% Pressure Tested
Threaded Ends • PTFE Disc
Integral Seal

Contains Lead. Not Intended for Use in Potable Water Systems

Not recommended for pulsating or vibrating service.
Do Not Install laying on side.
Keep seat clean.

MATERIAL LIST

NO.	DESCRIPTION	MATERIAL
1	Cap (1/4" - 1") Cap (1 1/4" - 2")	Brass Bronze
2	Washer	Brass
3	Body	Bronze
4	Disc	Brass
5	Hinge	Stainless Steel
6	Disc	PTFE

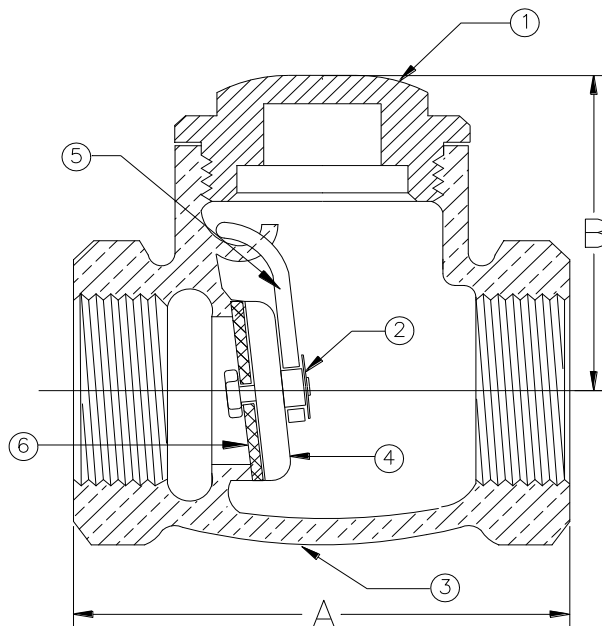

Size	1/4"	3/8"	1/2"	3/4"	1"	1 1/4"	1 1/2"	2"
A	1.81	1.81	2.14	2.51	3.03	3.45	3.81	4.44
B	1.22	1.22	1.28	1.53	2.06	2.20	2.20	2.86
Ship Wgt. (lbs.)	0.45	0.45	0.58	0.81	1.62	1.81	2.41	3.42
Qty. Unit Pack	12	12	12	12	6	6	4	2
Qty. Per Case	60	60	60	60	30	18	12	6