

# nVent CADDY Sway Bracing Cable, Spool and Kits

Brace Size	Cable Color	Certified Minimum Break Strength	
		Lbs	Kg
#12	Red	920	417.3
#18	White	1700	771.1
#36	Blue	4200	1905.1
#48	Yellow	7000	3175.1

## Certified Minimum Break Strength

The Seismic Wire Rope/Cable, contained in this shipment, has been pre-stretched according to the requirements of the ASCE®-19 Standard for "Structural Applications of Steel Cables for Buildings". The bracing assemblies contained in this shipment consist of the color-coded galvanized (zinc coated) or stainless steel seismic wire rope/cable, fixed ends (if any) which are factory attached thereto and accompanying field connection sleeves (ferrules) and fittings. These components are hereby certified to maintain the referenced minimum breaking strengths, when properly installed, utilizing a properly maintained swaging tool (nVent part number CSB3346SB, 402209, CSB12SBHS, 404461, CSB48, 402212, CSBBS121836, 402534, CSBHS02 or 402214), as further detailed herein and in the swager installation instructions.

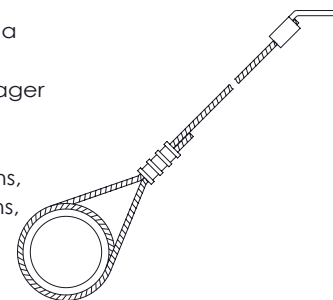

Note: For specific project installation information on, or application of, allowable breaking strengths, horizontal earthquake load resistance, brace locations, as well as fastener details, related strengths, applied load modulus of elasticity and % of elongation, contact nVent technical support.

Sway braces are intended to be installed in accordance with NFPA® -13 and the manufacturer's installation instructions.

## Section 1: Cable, Spools

Part Number	Article Number	Description	Cable Color	Brace Size	Cable Diameter		Sleeve Part Number	Sleeve Article Number
					inch	mm		
CSB12CBL	402190	250 ft of cable provided on a spool (sleeves sold separately)	Red	#12	3/32	2.4	CSB12SLVB	402194
CSB18CBL	402191		White	#18	1/8	3.2	CSB18SLVB	402195
CSB36CBL	402192		Blue	#36	3/16	4.8	CSB36SLVB	402196
CSB48CBL	402193		Yellow	#48	1/4	6.4	CSB48SLVB	402197
CSB12CBLSS	402510	250 ft of cable provided on a spool (sleeves sold separately)	SS	#12	3/32	2.4	CSB12SLVBSS	402514
CSB18CBLSS	402511		SS	#18	1/8	3.2	CSB18SLVBSS	402515
CSB36CBLSS	402512		SS	#36	3/16	4.8	CSB36SLVBSS	402516
CSB48CBLSS	402513		SS	#48	1/4	6.4	CSB48SLVBSS	402517

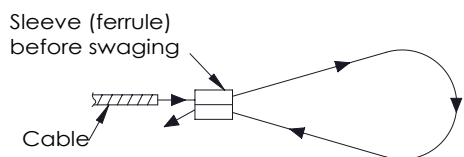

Step 1 - Insert cable through a sleeve (ferrule), and then back through the sleeve (ferrule) to create a loop.

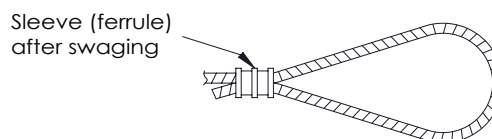

Step 2 - The sleeve (ferrule) has to be swaged by using a swaging tool (CSB3346SB, CSB13SBHS, CSBBS121836, CSB48 or CSBHS02). Refer to the tool manufacturers instructions for the number of swages needed per cable size.

Note: See page 4 for typical field connections to uninsulated pipe and for typical field connections to structure.

**WARNING:**

- nVent products shall be installed and used only as indicated in nVent product instruction sheets and training materials. Instruction sheets are available at [www.nVent.com](http://www.nVent.com) and from your nVent customer service representative.
- nVent products must never be used for a purpose other than the purpose for which they were designed or in a manner that exceeds specified load ratings.
- All instructions must be **completely** followed to ensure proper and safe installation and performance.
- Improper installation, misuse, misapplication or other failure to completely follow nVent's instructions and warnings may cause product malfunction, property damage, serious bodily injury and/or death, and void your warranty.
- Products that are manufactured using spring steel components shall be used only in a non-corrosive indoor environment.
- All pipe supports, hangers, intermediate components and structural attachments must **ONLY** be used as described herein and are **NEVER** to be used for any other purpose.

NOTE: All load ratings are for static conditions and do not account for dynamic loading such as wind, water or seismic loads, unless otherwise noted.

The customer is responsible for:

- Conformance to all governing codes.
- The integrity of structures to which the products are attached, including their capability of safely accepting the loads imposed, as evaluated by a qualified engineer.
- Using appropriate industry standard hardware as noted above.

**SAFETY INSTRUCTIONS:**

All governing codes and regulations and those required by the job site must be observed. Always use appropriate safety equipment such as eye protection, hard hat, and gloves as appropriate to the application.

nVent, nVent CADDY, nVent ERICO Cadweld, nVent ERICO Critec, nVent ERICO, nVent ERIFLEX, and nVent LENTON are owned by nVent or its global affiliates. All other trademarks are the property of their respective owners. nVent reserves the right to change specifications without prior notice.



Section 2: Cable, Kit with Universal Restraint Clip

Part Number	Article Number	Description	Cable Color	Brace Size	Cable Diameter		*Cable Length	
					inch	mm	feet	meter
CSB2W12URC38L10	-	Kit includes the following: 2 each cables that have a length given in the "Cable Length" column. 2 each URC clips attached to one end of each cable. URC clip is to be used with 3/8" or M10 fastener. 2 each of the appropriate sleeves.	Red	#12	3/32	2.4	10	3.0
CSB2W12URC38L20	-		Red	#12	3/32	2.4	20	6.1
CSB2W18URC38L10	-		White	#18	1/8	3.2	10	3.0
CSB2W18URC38L20	-		White	#18	1/8	3.2	20	6.1
CSB2W12URC12L10	-	Kit includes the following: 2 each cables that have a length given in the "Cable Length" column. 2 each URC clips attached to one end of each cable. URC clip is to be used with 1/2" or M12 fastener. 2 each of the appropriate sleeves.	Red	#12	3/32	2.4	10	3.0
CSB2W12URC12L20	-		Red	#12	3/32	2.4	20	6.1
CSB2W18URC12L10	-		White	#18	1/8	3.2	10	3.0
CSB2W18URC12L20	-		White	#18	1/8	3.2	20	6.1
CSB2W18URC12L10	-		White	#18	1/8	3.2	10	3.0
CSB2W36URC12L10	-		Blue	#36	3/16	4.8	10	3.0
CSB2W36URC12L20	-		Blue	#36	3/16	4.8	20	6.1
CSB2W48URC12L10	-		Yellow	#48	1/4	6.4	10	3.0
CSB2W48URC12L20	-		Yellow	#48	1/4	6.4	20	6.1
CSB2W36URC58L10	-		Kit includes the following: 2 each cables that have a length given in the "Cable Length" column. 2 each URC clips attached to one end of each cable. URC clip is to be used with 5/8" or M16 fastener. 2 each of the appropriate sleeves.	Blue	#36	3/16	4.8	10
CSB2W36URC58L20	-	Blue		#36	3/16	4.8	20	6.1
CSB2W48URC58L10	-	Yellow		#48	1/4	6.4	10	3.0
CSB2W48URC58L20	-	Yellow		#48	1/4	6.4	20	6.1
CSB4W12URC38L05	-	Description at top with 4 URC, sleeves and cables.	Red	#12	3/32	2.4	5	1.5

\* The actual length of cable provided is the length given in the chart plus an additional 4ft (1.2 m).

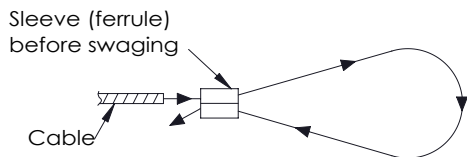

Step 1 - Insert cable through a sleeve (ferrule), and then back through the sleeve (ferrule) to create a loop.

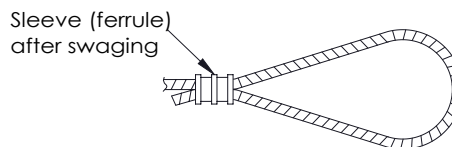

Step 2 - The sleeve (ferrule) has to be swaged by using a swaging tool (CSB3346SB, CSB12SBHS, CSB48, CSBBS121836 or CSBHS02). Refer to the tool manufacturers instructions for the number of swages needed per cable size.

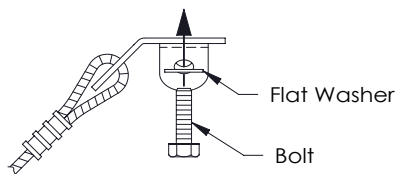

Step 3 - Insert fastener with washer through the fastener hole and tighten to the structure.

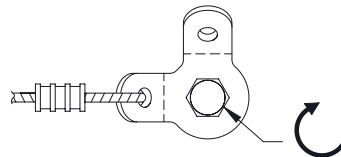

Note: See page 4 for typical field connections to uninsulated pipe and for typical field connection:

Section 3: Cable, Kit (without end fittings)

Part Number	Article Number	Description	Cable Color	Brace Size	Cable Diameter		*Cable Length	
					inch	mm	feet	meter
CSB12B00L10	402233	Kit includes the following: 2 each cables cut to the useable length given in the "Cable Length" column. 4 each of the appropriate sleeves.	Red	#12	3/32	2.4	10	3.0
CSB18B00L10	402234		White	#18	1/8	3.2		

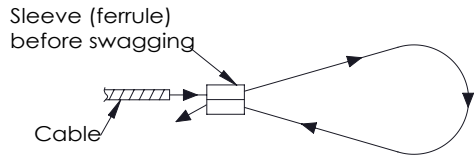

Step 1 - Insert cable through a sleeve (ferrule), and then back through the sleeve (ferrule) to create a loop.

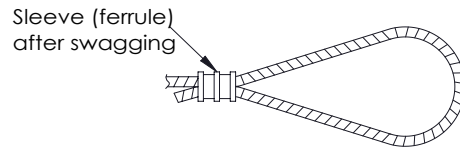

Step 2 - The sleeve (ferrule) has to be swagged by using a swaging tool (CSB3346SB, CSB13SBHS or CSBHS02). Refer to the manufacturers instructions for the number of swages needed per cable size.

Note: See page 4 for typical field connections to uninsulated pipe and for typical field connections to structure.

Field Connection to Extend Brace Length

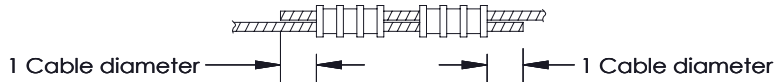

Step 1 - Slide two sleeves (ferrules) onto overlapping cables.

Step 2 - The sleeve (ferrule) has to be swagged by using a swaging tool (CSB3346SB, CSB13SBHS, CSB48 or CSBHS02). Refer to the manufacturers instructions for the number of swages needed per cable size.

Typical Field Connections to Uninsulated Pipe

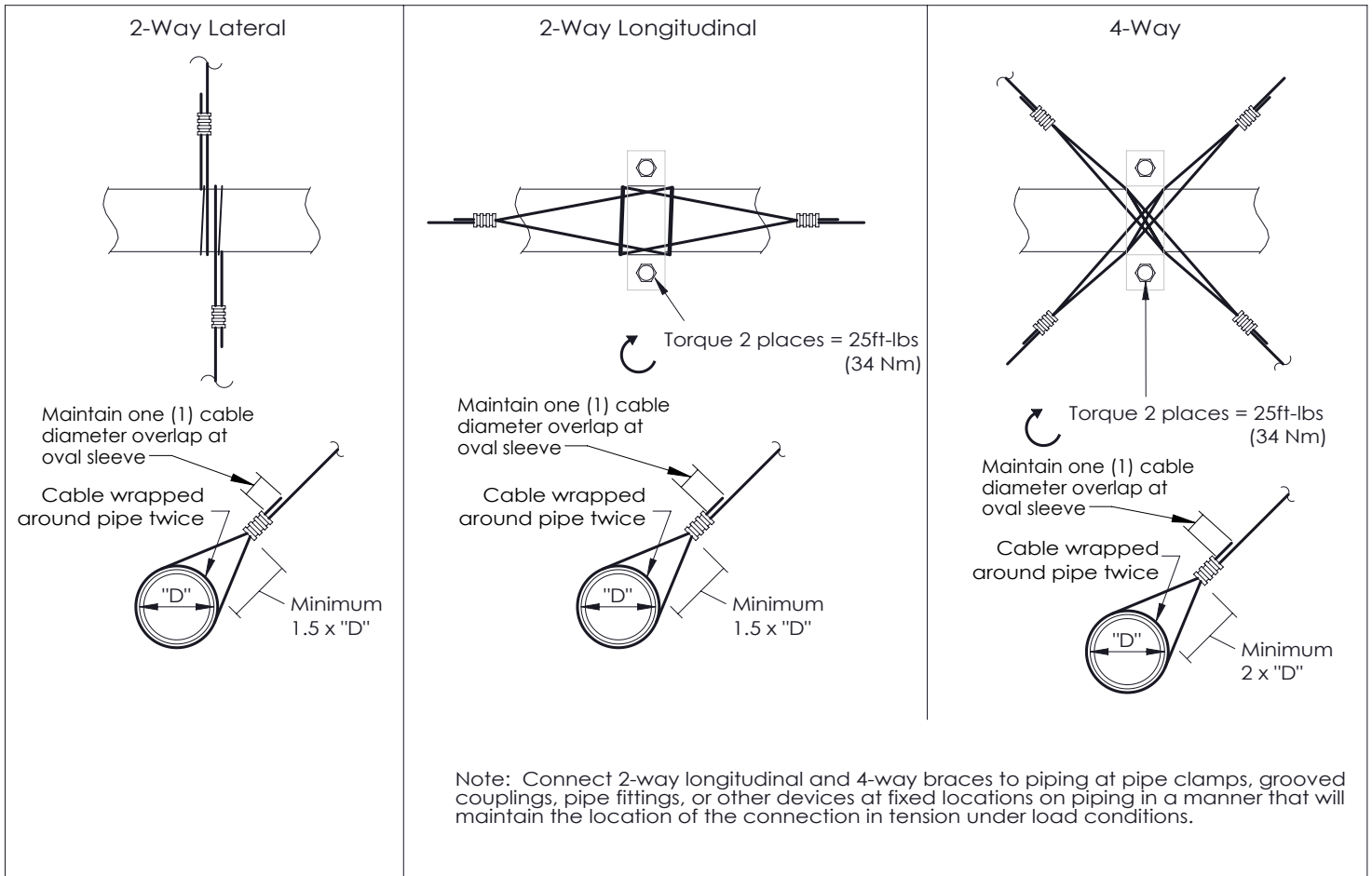

Typical Field Connections to Structure

Part Number  
CSBURCXX  
CSBURCRXX  
CSBURC48XX

Article Number  
402198 - 402206

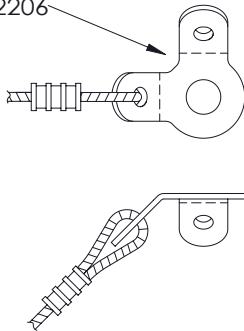

Part Number  
CSBNPCXX

Article Number  
402208

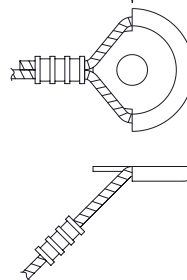

Looped Connection  
Cable can be looped around the top cord of a barjoist at the panel point

Maintain an angle less than 45°

