

INSTALLATION INSTRUCTIONS SERIES ET70WP LOW PROFILE WEATHERPROOF SPEAKER STROBE APPLIANCE

Use this product according to this instruction manual. Please keep this instruction manual for future reference.

GENERAL

Series ET70WP Low Profile Speaker Strobe appliances are UL Listed for indoor/outdoor use under Standard 1638 for Visual Signal Appliances, Fire Protective Service and UL Standard 1480 for Speaker Appliances. Models with amber, blue, green or red lenses are UL Listed under Standard 1638 (Visual Signaling Appliance) for Private Mode Emergency and General Utility Signaling. The ET70WP with clear lens is UL-Listed to Standard 1971 for Signaling Devices for the Hearing Impaired when installed indoors. For outdoor applications the ET70WP must be mounted to a Weatherproof Backbox (IOB). The ET70WP is designed for multiple power requirements with high dBA output at each power tap. This model offers a choice of field selectable taps, 1/8W to 8W for either 25.0V_{RMS} or 70.0V_{RMS} audio systems. The low profile design incorporates a high efficiency speaker for maximum output at minimum power across a frequency range of 400Hz to 4000Hz and features a sealed back construction for extra protection and improved audibility. The Low Profile Speaker Strobes can provide a non-synchronized strobe appliance when connected directly to a fire alarm control panel (FACP), or provide a synchronized strobe appliance when used in conjunction with a Sync Module (SM), Dual Sync Module (DSM), or Cooper Wheelock's power supplies. The strobes use a Xenon flashtube with solid state circuitry enclosed in a polycarbonate lens to provide maximum visibility and reliability for effective visible signaling.

WARNING: Please read these instructions carefully. Failure to comply with any of the following instructions, cautions and warnings could result in improper application, installation and/or operation of these products in an emergency situation, which could result in property damage and serious injury or death to you and/or others.

CAUTION: Not recommended for use at refrigerator/freezer door entrances or other areas with persistent condensations.

SPECIFICATIONS

Table 1: UL Listed Models and Ratings

Model	Voltage	Speaker							Regulated Voltage (VDC/V _{RMS})	Regulated Voltage Range (VDC/V _{RMS})	Rated Strobe Candela (cd)		
		Reverberant dBA at 10 Feet (Rated Watts)									UL1971	UL1638 (Note 1)	Cold Ambient (Note 2)
		1/8	1/4	1/2	1	2	4	8					
ET70WP-2475W	25/70	77	80	83	86	88	91	93	24	16-33	30	180	115
ET70WP-2475C	25/70	77	80	83	86	88	91	93	24	16-33	15	180	115
ET70WPA-2475W	25/70	77	80	83	86	88	91	93	24	16-33	n/a	145	92
ET70WPA-2475C	25/70	77	80	83	86	88	91	93	24	16-33	n/a	145	92
ET70WPB-2475W	25/70	77	80	83	86	88	91	93	24	16-33	n/a	71	45
ET70WPG-2475W	25/70	77	80	83	86	88	91	93	24	16-33	n/a	111	71
ET70WPR-2475W	25/70	77	80	83	86	88	91	93	24	16-33	n/a	46	29
ET70WPR-2475C	25/70	77	80	83	86	88	91	93	24	16-33	n/a	46	29
ET70WP-24115C	25/70	77	80	83	86	88	91	93	24	16-33	115	115	73
ET70WP-24135W	25/70	77	80	83	86	88	91	93	24	16-33	135	135	86
ET70WP-24177C	25/70	77	80	83	86	88	91	93	24	16-33	177	177	113
ET70WP-24185W	25/70	77	80	83	86	88	91	93	24	16-33	185	185	118

NOTES

- UL1638 is an on-axis rating where the following applies: WARNING: not to be used as a visual public model alarm notification appliance. Use UL1971 ratings for all public mode applications.
- All products are listed for indoor and outdoor use as follows: Clear Lens at -40 F (-40 C) to 150 F (66 C), Colored Lens at -31 F (-35 C), both Clear and Colored Lens with maximum of 95% RH.
- Strobes will produce 1 flash per second over the Regulated Voltage range.
- Strobes with clear and amber lenses meet the required light distribution pattern in UL1971.
- The effect of shipping and storage temperatures must not adversely affect the performance of the appliance when it is stored in the original cartons and is not subjected to misuse or abuse.
- The maximum supervision voltage is 33 volts DC.
- Frequency range of speakers is 400-4000Hz. dBA is rated per UL Standard 1480 for Speaker Appliances.

CAUTION: Always operate audio amplifiers and speakers within their specified ratings. Excessive input may distort sound quality and may damage audio equipment. Do not exceed 100% of speaker input voltage per UL 1480. Improper input voltage can damage speaker. If distortion is heard, check for clipping of the audio appliance with an oscilloscope and reduce the amplifier input level or gain level to eliminate any clipping.

Table 2: Strobe Current Ratings (AMPS)

Maximum RMS Current						
UL Voltage		2475	24115	24135	24177	24185
DC	16-33VDC	0.138	0.300	0.300	0.420	0.420
FWR	16-33V _{RMS}	0.222	0.455	0.455	0.645	0.645

When calculating the total currents, use Table 2 to determine the highest value of RMS current for an individual strobe, then multiply these values by the total number of strobes. Add the currents for any other appliances, including audible signaling appliances powered by the same source and include any required safety factors.

NOTE: The maximum number of strobes on a single notification appliance circuit must not exceed 50.

CAUTION: These strobes are UL Listed as Regulated. They are intended to be used with FACPs whose notification circuits are UL Listed as Regulated. These appliances must not be used on UL Listed Special Application notification circuits unless the appliances are identified to be compatible in the installation instructions of the FACP.

WARNING: These strobes were tested to the regulated voltage limits of 16-33 Volts for 24V models using filtered DC or unfiltered full-wave-rectified voltage. Do not apply voltage outside of this range.

WARNING: Check the minimum and maximum output of the power supply and standby battery and subtract the voltage drop from the circuit wiring resistance to determine the applied voltage to the strobes. The maximum wire impedance between strobes must not exceed 35 ohms.

CAUTION: Strobes are not designed to be used on coded systems in which the applied voltage is cycled on and off.

WARNING: Ensure the total RMS current required by all appliances that are connected to the system's primary and secondary power sources, notification appliance circuits, SM, DSM sync modules, or Cooper Wheelock's power supplies does not exceed the power source's rated capacity or the current ratings of any fuses on the circuits to which these appliances are wired. Overloading power sources or exceeding fuse ratings could result in loss of power and failure to alert occupants during an emergency, which could result in property damage and serious injury or death to you and/or others.

WIRING AND MOUNTING INFORMATION

CAUTION: Figure 1 shows the maximum number of field wires (conductors) that can enter the backbox used with each mounting option. If these limits are exceeded, there may be insufficient space in the backbox to accommodate the field wires and stresses from the wires could damage the product.

WARNING: This unit must be mounted on a flat surface with the surface covering the entire back surface of the backbox. When used in an outdoor application or a NEMA 3R application knockouts in the rear of the backbox must remain intact.

CAUTION: Two screws must be used to mount backbox securely using both tabs included with the backbox.

Although the limits shown for each mounting option comply with the National Electrical Code (NEC), Cooper Wheelock recommends use of the largest backbox option shown and the use of approved stranded field wires, whenever possible, to provide additional wiring room for easy installation and minimum stress on the product from wiring.

For wiring information, refer to Figures 2 and 3 below:

- This model has in-out wiring terminals that accept two #12 to #18 American Wire Gauge (AWG) wires at each screw terminal. Strip leads 3/8 inches and connect to screw terminals.
- Break all in-out wire runs on supervised circuits to ensure integrity of circuit supervision as shown in Figure 2. The polarity shown in the wiring diagrams is for operation of the appliances.

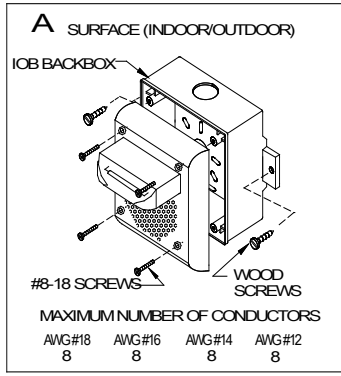

Figure 1

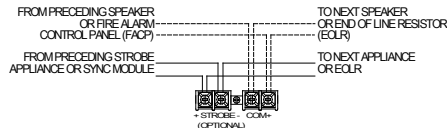

Figure 2

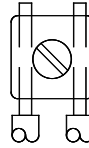

Figure 3

MOUNTING PROCEDURES

1. The knock-out opening on the backbox is sized for a 1/2" conduit and matching connector. Ensure a proper watertight conduit fitting is used to connect the backbox for outdoor/severe environment applications. Conduit entrances to the backbox should be selected to provide sufficient wiring clearance for the installed product. Do not pass additional wires (used for other than the signaling appliance) through the backbox. Such additional wires could result in insufficient wiring space for the signaling appliance.
2. When terminating field wires, do not use more lead length than required. Excess lead length could result in insufficient wiring space for the appliance.
3. Use care and proper techniques to position the field wires in the backbox so they use minimum space and produce minimum stress on the product. This is especially important for stiff, heavy gauge wires and wires with thick insulation or sheathing.
4. Connect field wires to the terminal block (polarity must be observed).
5. Bend the field wires up 90° at the connection to the terminal block, and carefully push the field wires into the backbox by hand.
6. Carefully press the unit to the backbox, verifying it is in contact with the gasket all the way around. It should not be resting on the lip of the backbox.
7. Screw the speaker strobe to the IOB using the #8-18 screws supplied.

WARNING: The ET70WP appliance is a FIRE ALARM DEVICE - DO NOT PAINT.

WARNING: When installing strobes in an open office or other areas containing partitions or other viewing obstructions, special attention should be given to the location of the strobes so that their operating effect can be seen by all intended viewers, with the intensity, number, and type of strobes being sufficient to ensure the intended viewer is alerted by proper illumination. Failure to do so could result in property damage and serious injury or death to you and/or others.

WARNING: A small possibility exists that the use of multiple strobes within a person's field of view, under certain circumstances, might induce a photosensitive response in persons with epilepsy. Strobe reflections in a glass or mirrored surface might also induce such a response. To minimize this possible hazard, Cooper Notification strongly recommends that the strobes installed should not present a composite flash rate in the field of view which exceeds five (5) hz at the operating voltage of the strobes. Cooper Notification also strongly recommends that the intensity and composite flash rate of installed strobes comply with levels established by applicable laws, standards, regulations, codes and guidelines.

NOTE: NFPA 72/ANSI 117.1 conform to ADAAG Equivalent Facilitation Guidelines in using fewer, higher intensity strobes within the same protected area.

GROUNDING: Connect the ground wire to backbox. Install signaling appliance to backbox using mounting screws provided.

WARNING: Check electrical ratings specified in Tables 1 and 2 (as appropriate) to ensure proper electrical input. Be sure that speaker wiring is connected to speaker terminals only and strobe wiring is connected to strobe terminals only. Ensure the wiring at FACP is correct. Improper electrical input can damage the product or cause it to malfunction, which could result in property damage and serious injury or death to you and/or others.

1. Each doubling of rated watts increases sound output by 3 dBA. Field selectable input terminals are provided on each unit. The following wattage selections are available: 1/8W, 1/4W, 1/2W, 1W, 2W, 4W, and 8W.
2. Each letter on the Input Terminals as shown below in Figures 4 and 5, corresponds to a plug position of the header located on the printed circuit board. Select voltage and wattage as shown in Table 3.
3. A 10 µF blocking capacitor for DC supervision of audio lines by the FACP is factory wired in series with the speaker input.

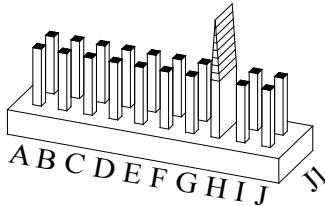

Figure 4: Jumper plug is used to select tap settings which = dBA loudness.

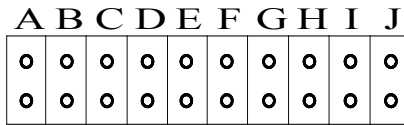

Figure 5: Tap Settings (Factory setting is 70V @ 1/2W (Tap H))

NOTE: Use needle-nose pliers to pull and properly insert the jumper plug to the desired tap setting.

WARNING: The speaker strobe appliance must be field set to the desired dBA sound output level before it is installed. This is done by properly inserting jumper plugs in accordance with these instructions. Incorrect settings will result in improper performance, which could result in property damage and serious injury or death to you and/or others.

Position	25V	70V
A	8	-----
B	4	-----
C	2	-----
D	1	8
E	1/2	4
F	1/4	2
G	1/8	1
H	-----	1/2
I	-----	1/4
J	-----	1/8

The light output graphs for the ET70WP Ceiling and Wall Candela are shown in figures 6 and 7.

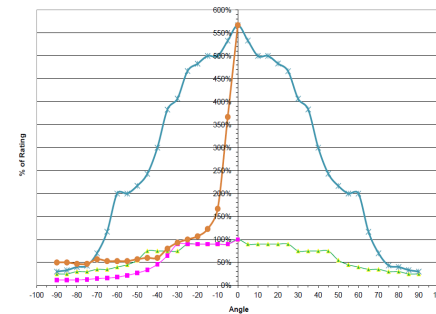

Figure 6 ET70WP Expected Candela Ceiling

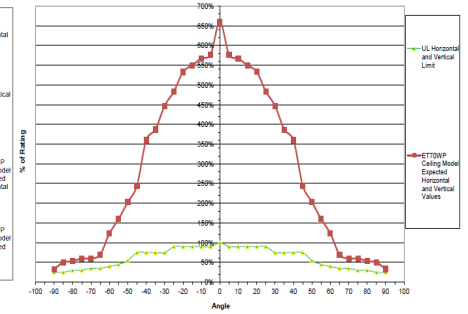

Figure 7 ET70WP Expected Candela Wall