



Technology that saves lives

Intelligent Fire Alarm Systems

FX-64, FX-1000



FDNY
COA 6231



7165-1657:
0244



Overview

Kidde brand intelligent life safety systems offer the power of advanced intelligent processing in configurations that deliver uncomplicated solutions for small to mid-sized applications. With intelligent detection, rotary addressing, automatic device mapping, optional Ethernet® connectivity, and a full line of easily-configured option cards and modules, these flexible systems offer versatility that benefits building owners and contractors alike.

The FX-64 provides one Class A or Class B intelligent device loop that supports up to 64 device addresses, and two Class B Notification Appliance Circuits (NACs). Optional Class A device wiring is available with the use of a module.

The FX-1000 provides one Class A or Class B intelligent device loop that supports up to 250 device addresses. Loop controller modules may be added in combination to expand total system capacity in 250-point increments to up to 1,000 device addresses. The FX-1000 panel includes four NACs that may be wired for either Class A or Class B operation.

The RZI16-2RS module adds even more capacity to FX installations by adding up to 16 conventional device circuits and two additional notification appliance circuits. This makes them an ideal retrofit solution that can accommodate new intelligent detectors, as well as existing conventional devices.

Features

- Auto-programming speeds installation time
- Form C contacts for alarm and trouble, Form A for supervisory
- Easy-to-configure rotary addressing
- Optional Ethernet port for diagnostics, programming and a variety of system reports
- Two programmable switches with LEDs and custom labeling
- Supports horn silence over two wires, and UL 1971-compliant strobe synchronization
- Class B or Class A wiring
- Ground fault detection by module
- Supports up to eight serial annunciators, (LCD, LED-only, and graphic interface)
- Can use existing wiring for most retrofit applications
- Upload/download remotely or locally
- Two-level maintenance alert reporting
- Pre-alarm and alarm verification by point
- Adjustable detector sensitivity
- 4 x 20 character backlit LCD display
- Optional earthquake hardening: seismic Importance Factor 1.5
- Standalone operation
- Transmission test frequency by hour
- *Alarm ON* command manually activates alarm condition

Application

Kidde FX Series life safety systems are powerful intelligent solutions for small to mid-sized buildings. Advanced analog technology delivers the benefits of flexible system installation, while clean and easy-to-operate user interfaces make panel operation and system maintenance quick and intuitive.

Reliability you can count on

The inherent fault-tolerant characteristics of Analog/Addressable Technology boosts the reliability of Kidde fire alarm systems. When combined with FX Series smoke and heat detectors, these systems deliver a level of dependability not previously available for small to mid-sized applications. All Kidde systems are built to exacting reliability benchmarks and meet international standards for quality, in addition to agency listings for dependability.

Flexibility built right in

Two fully-programmable front panel switch/LED combinations provide an added measure of flexibility. Their slide-in labels take the mystery out of custom applications, and present a clean finished appearance.

Perfect for retrofits

Kidde FX Series control panels are particularly well-suited to retrofit applications. All connections are made over standard wiring – no shielded cable required. This means that in most situations existing wiring can be used to upgrade a legacy control panel to FX technology without the expense or disruption of rewiring the entire building. FX control panels also support the ingenious RZ116-2RS zone module, which adds up to 16 conventional circuits and two NACs. This combination easily accommodates new intelligent detection alongside existing conventional circuits, making it an unbeatable solution in the retrofit market.

Signals with a difference

Kidde FX Series NACs are configurable to fully support renowned Genesis Series notification appliances. When used with FX control panels these devices offer precision synchronization of strobes to UL 1971 standards – without the need for external modules. This feature also allows connected horns to be silenced while strobes on the same two-wire circuit continue to flash until the panel is reset.

Clear-cut remote annunciation

Remote annunciation is a strong suit of the FX Series fire alarm systems. Up to eight annunciators can be installed on a single system. Compatible annunciators include a range of LED and LCD models that provide zone or point annunciation, as well as common control capabilities. FX control panels also supports graphic annunciation with optional Graphic Annunciator interface modules. Each interface provides common control, indicators, and 32 LEDs.

Scalable IP and Cellular Communications

Several popular third-party IP/Cellular communicators have been tested with the FX intelligent control panels and are compatibility listed to UL864. The IP/Cellular communicators meet NFPA72 2013 edition requirements for sole or secondary transmission paths. Using IP/Cellular communicators can reduce the cost of ownership by eliminating POTS lines. Please see the FX control panel compatibility documentation part number 3102355-EN for a full list of compatible communicators.

A complete line of accessories

FX Series life safety systems are supported by a complete line of analog/addressable detectors, modules and related equipment. Consult the Ordering Information section for details.

Programming and remote diagnostics

Kidde FX Series life safety systems are simple to set up, yet offer advanced programming features that put these small building panels into a class of their own. The auto programming feature quickly gets the panel operational using factory default settings. Basic zone and point settings can be programmed easily through the front panel interface, so the system is up and running in no time.

The FX series panels can also interface to a PC running the FX-CU configuration utility software. This option offers full system configuration in the familiar Windows® operating environment. Connection is typically made to a laptop through the panel's optional RS-232 communications port, which can also be used to connect a system printer.

Among the many innovative features of FX Series control panels is the optional network card. This module provides a standard 10/100 Base T Ethernet® network connection that permits access to the control panel from any remote location with the correct communications protocols. The connection can be used to download to the panel from the FX-CU, or upload and view system reports using the FX-CU.

Available system reports include: Correlation groups, Device details, Device maintenance, History, Internal status, System configuration, System status, Walk test, and Dialer.

Dimensions

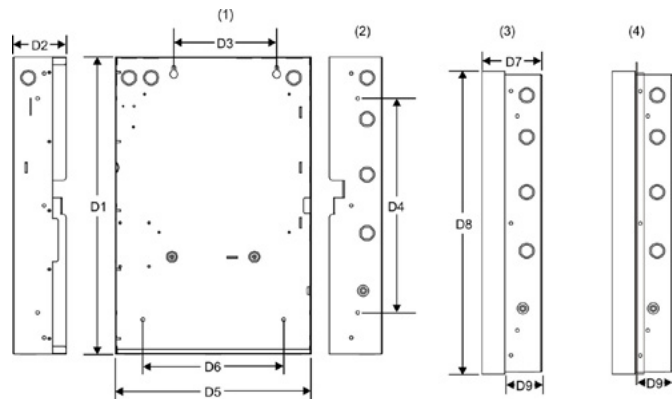

(1) Surface Mounting Holes

(3) Backbox with Door Attached

(2) Semi-flush mounting Holes

(4) Backbox with door and trim kit attached.

Panel dimensions, in (cm)

Model	D1*	D2	D3	D4	D5*	D6	D7	D8	D9
FX-1000	28.0 (71.1)	3.85 (9.8)	9.0 (22.8)	22.0 (55.8)	15.75 (40.0)	10.25 (26.0)	3.9 (9.9)	28.2 (71.6)	2.7 (6.8)
FX-64	21.5 (54.6)	3.85 (9.8)	7.5 (19.0)	15.5 (39.4)	14.25 (36.2)	10.25 (26.0)	3.9 (9.9)	21.7 (55.1)	2.7 (6.8)

* Add 1-1/2 in. (3.81 cm) to D1 and D5 dimensions for trim kit. The trim kit provides 0.75 inches (1.9 cm) of trim to the top, bottom, and sides of the backbox.

System Layout

FX-1000

Any combination of two single- or dual-loop modules

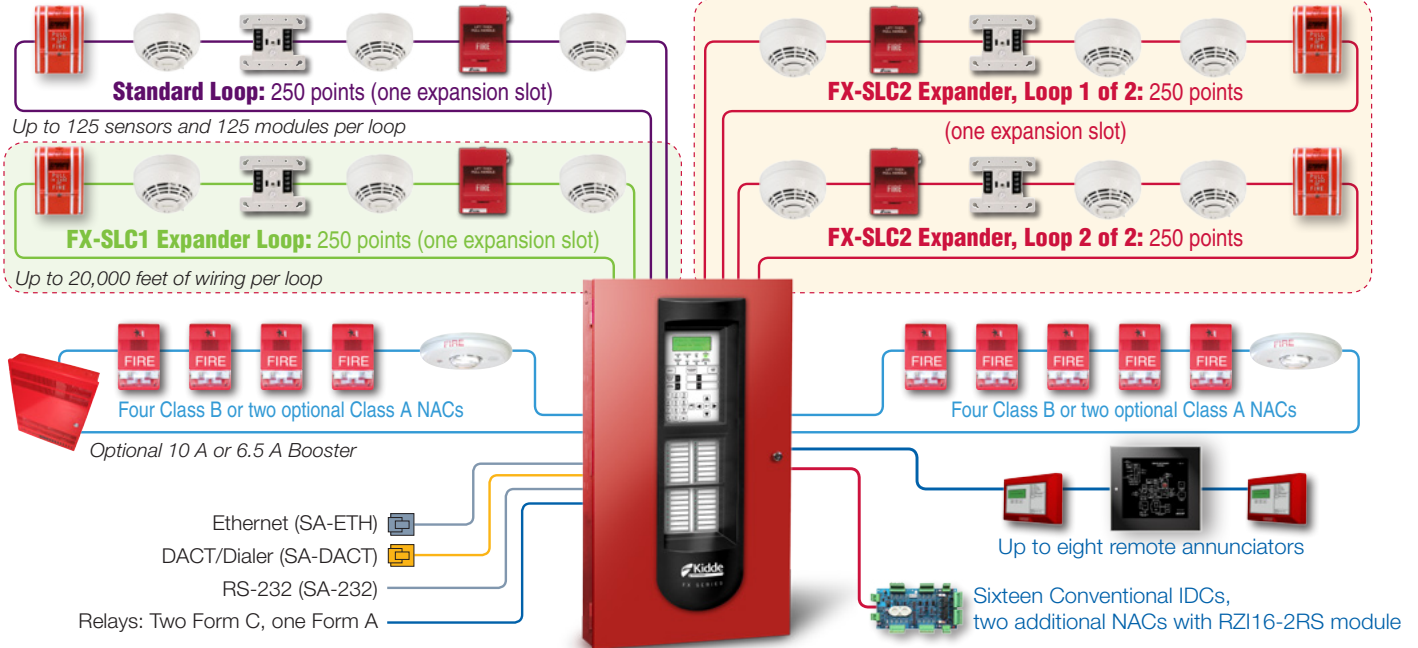

Each FX-1000 panel has room for up to two loop controller modules in any combination of single or dual 250-device loops. FX-1000 comes with one loop that supports up to 125 detectors and 125 modules.

Panel Layout

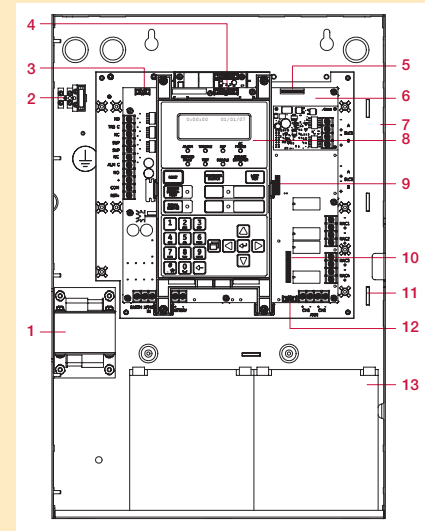

- 1 Transformer
- 2 Main AC wiring block & fuse holder
- 3 RS-232 card connector (J3)
- 4 Dialer card connection (J8)
- 5 Ethernet card connector (J1)
- 6 Main circuit board
- 7 Panel backbox enclosure
- 8 Operator interface
- 9 SLC card connector (J7)
- 10 Class A card connector (J2)
- 11 Tie wrap mounts
- 12 LED expander connector (J6)
- 13 Standby batteries

FX-64

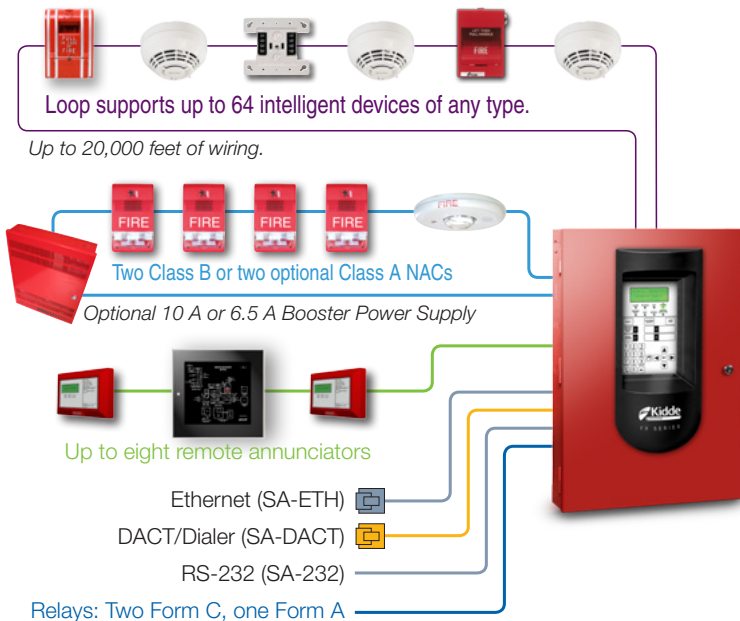

Each FX-64 panel ships with one loop controller that supports 64 devices of any type. This panel's device capacity cannot be expanded.

Wiring & Configuration

Device loop

The system provides one device loop circuit with a total capacity of 125 detectors and 125 module addresses. The loop circuit is supervised for opens, shorts, and grounds.

Circuit specifications	FX-1000	FX-64
Device loops	One Class B or A loop, supporting 125 detectors and 125 modules. Expandable to four loops.	One Class B or A loop, supporting 64 devices of any kind.
Communication line voltage	Maximum 20 V peak-to-peak	
Circuit current	0.5 A max	
Circuit impedance	66Ω total, 0.5 μF, max	
Isolators	64 maximum	
Signal Synchronization	Supported on a system-wide basis (all device loops) when using an FX-NAC addressable notification appliance circuit (NAC) module and Genesis or Enhanced Integrity notification appliances.	

Class B wiring

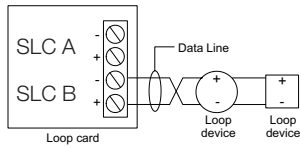

Class A wiring

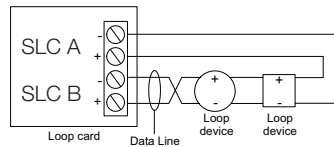

Notification appliance circuits (TB2)

FX-1000 control panels come equipped with four notification appliance circuits. FX-64 control panels come with two NACs. Each circuit can be individually configured for continuous, temporal, synchronized, and coded output.

Specifications	FX-1000	FX-64
Circuit Type	4 Class B or 2 Class A	2 Class B or 2 Class A with SA-CLA module
Voltage	24 VFWR	
Current	6.0 A total, 2.5 A max. per circuit at 120/230 VAC 60 Hz. 5.0 A total, 2.5 A max. per circuit at 230 VAC 50 Hz.	3.75 A total, 2.5 A max. per circuit at 120/230 VAC 60 Hz. 3.0 A total, 2.5 A max. per circuit at 230 VAC 50 Hz.
Impedance	26 Ω total, 0.35 μF max	
EOLR	15 K Ω, ½ W	
Synchronization	Supported system-wide	

Class B wiring

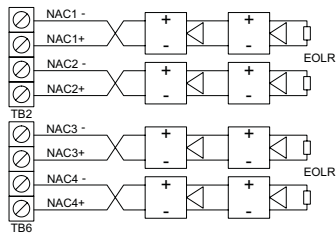

Class A wiring

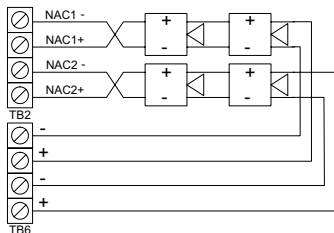

Marking indicates output signal polarity when the circuit is active. Polarity reverses when the circuit is not active. Wire notification appliances accordingly. Notification appliance polarity shown in active state.

Auxiliary & Smoke power outputs (TB3)

The control panel provides two auxiliary power outputs that can be used for powering ancillary equipment such as remote annunciators and two wire smoke detectors. Aux 2 can be software selected to operate continuously. The circuit is supervised for shorts and grounds.

Circuit specifications

Circuit voltage range	21.9 to 28.3 V
Resettable circuit (Aux power 2)	24 VDC nominal at 500 mA Use this circuit for powering two-wire smoke detectors.
Continuous circuit (Aux power 1)	24 VDC nominal at 500 mA.

Note: Any current above 0.5 amp connected to both Aux 1 and 2 will reduce the total available NAC power by that amount.

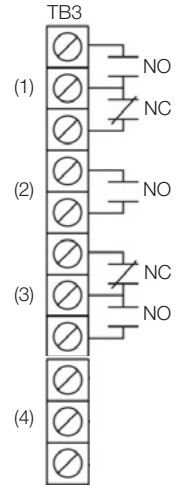

- (1) Trouble
- (2) Supervisory
- (3) Alarm
- (4) Smoke/Aux

Alarm, trouble, and supervisory relay (TB3)

The trouble relay is normally-open, held closed, and opens on any trouble event or when the panel is de-energized. The supervisory relay is normally-open, and closes on any supervisory event. The alarm relay changes over on any alarm event.

Relay specifications

	Alarm	Trouble	Supervisory
Type	Form C		Form A
Voltage	24 VDC at 1 A resistive		24 VDC at 1 A resistive

Relay circuits can only be connected to power-limited sources.

Annunciator loop (TB4)

The control panel provides a connection for up to eight serially driven and supervised remote annunciators.

Circuit specifications

Device loops	Class B (Style Y) or Class A (Style Z)
Circuit voltage	2.55 V
Circuit current	30 mA max
Circuit impedance	Up to 8 annunciators or 4000 feet

Class B



Class A

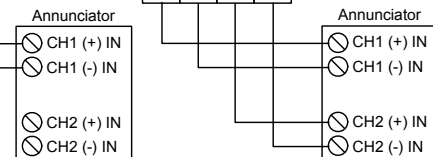

Option Cards

Kidde FX Series panels are supported by a complete line of modules and related equipment that enhance performance and extend system capabilities. Option cards plug directly into the control panel main circuit board or are connected to it with a ribbon cable. After installation, terminals remain accessible. The cabinet provides ample room for wire routing, keeping wiring neat at all times.

Single and Dual Loop Controller Cards

The FX-SLC1 is a single loop controller card that can be used with the FX-64 as a replacement for the standard 64-point loop, or with the FX-1000 as a 250-point expansion module.

The FX-SLC2 is a 500-point dual loop controller card for the FX-1000 that provides two IDC circuits, each with 125 detector addresses and 125 module addresses.

Specifications	FX-SLC1	FX-SLC2
Device Addresses	FX-1000: one loop, 250 device addresses FX-64: 64 device addresses	FX-1000: two loops, 500 device addresses
Wiring	Class B or Class A	
Operating Voltage	24 VDC	
Operating Current (fully loaded loop)	Standby: 55 mA Alarm: 80 mA	Standby: 45 mA Alarm: 70 mA
<i>Note: These ratings do not include the use of two-wire smoke modules.</i>		
Communication Line Voltage	Max. 20.6 V peak-to-peak	
Terminal Rating	12 to 18 AWG (0.75 to 2.5 mm ²)	
Circuit Current	0.5 A max.	
Max total loop resistance	66 Ω	
Max total loop capacitance	0.5 μF	
Isolators	64 isolators maximum per loop (total both isolator bases and modules)	
Ground Fault Impedance	0 to 5 kΩ	
Operating Environment	32 to 120°F (0 to 49°C) 0 to 93% noncondensing at 90°F (32°C)	

SA-ETH Ethernet Interface Card

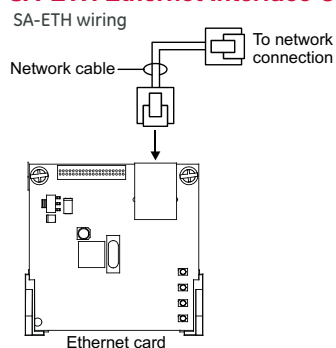

The SA-ETH card provides a standard 10/100 Base T Ethernet network connection for connecting to an intranet, a local network, or the Internet. The card can be used to download configuration programming from the FX-CU to the panel over the network.

The Ethernet card is installed on the plastic assembly and connects to the main circuit board via a ribbon cable.

SA-ETH specifications

Ethernet	10/100 Base T
Operating environment	
Temperature	32 to 120°F (0 to 49°C)
Humidity	0 to 93% RH, noncondensing at 90°F (32°C)

RZ116-2RS Remote Zone Interface Module

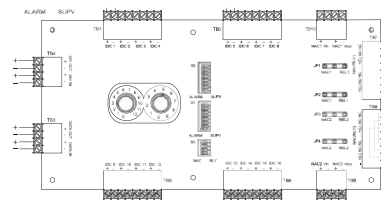

The RZ116-2RS Addressable Remote Zone Interface Module is an addressable device that provides connections for sixteen Class B Initiating Device Circuits and two Class B Supervised Output Circuits. The inputs and outputs can be configured individually for several device types.

The device address is set using the two rotary switches located on the front of the module. The RZ116-2RS requires 18 consecutive addresses on the Signaling Line Circuit (SLC).

The RZ116-2RS incorporates two 8-segment DIP switches that are used to select the Alarm or Supervisory default device type for each of the 16 IDC circuits. The module also includes one 4-segment DIP switch used to select the default Relay or NAC output device type. Device types other than the default are accomplished through programming.

RZ116-2RS Specifications

Voltage	
24V/Aux nominal:	24 VDC
Supervisory current:	250 mA at 24 VDC nominal
Alarm current:	1000 mA
24V/Aux minimum:	18.4 VDC
24V/Aux maximum:	26.4 VDC
NAC1, NAC2 nominal:	24 VDC
Current	
Standby current for 4.7 k EOL (U.S.)	4.8 mA/ circuit
Standby current for 3.9 k EOL (Canada)	5.7 mA/ circuit
Alarm current at nominal voltage	31.1 mA/ circuit
Relay outputs	
Quantity	2
Type Rating (pilot duty)	Programmable 24 VDC at 2.5 A
Input circuit wiring resistance	25 Ω per wire
Initiating device circuits	
Quantity	16
EOL resistor	4.7 kΩ (U.S.); 3.9 kΩ Canada
Zone voltage	22.78 V for 4.7 kΩ (U.S.) 22.08 V for 3.9 kΩ (Canada)
Alarm current	31.1 mA/ channel at nominal voltage
Alarm impedance range	< 680 Ω
Trouble impedance range	> 5.55 kΩ
Supervised output circuits	
EOL resistor	15 kΩ
Quantity	2
Short circuit detection	< 2.6 kΩ
Open circuit detection	> 61.9 kΩ
Contact ratings	24 VDC at 2.5 A (5 A for two NACs)
Compatible cabinets	MFC(A), FX-1000, APS

SA-DACT Dialer

The SA-DACT provides communications between the control panel and the central station over a telephone line system. It transmits system status changes (events) to a compatible digital alarm communicator receiver over the public switched telephone network. The dialer is capable of single, dual, or split reporting of events to two different account and telephone numbers. The modem feature of the SA-DACT can also be used for uploading and downloading panel configuration, history, and current status to a PC running the FX-CU.

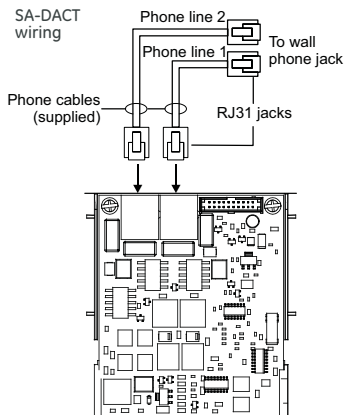

The dialer phone lines connect to connectors on the dialer's main circuit board. Phone line 1 connects to connector J4 and phone line 2 connects to connector J1.

The SA-DACT queues messages and transmits them based on priority (alarm, supervisory, trouble, and monitor). Activations are transmitted before restorations.

The SA-DACT is installed on the plastic assembly and connects to the main circuit board via a ribbon cable.

SA-DACT specifications

Phone line type	One or two loop-start lines on a public, switched network
Phone line connector	RJ-31/38X (C31/38X)
Communication formats	Contact ID (SIA DC-05)
Operating environment	
Temperature	32 to 120°F (0 to 49°C)
Humidity	0 to 93% RH, noncondensing at 90°F (32°C)

Compatible DACRs

Receiver	Models	Formats
Ademco	685	Contact ID
FBII	CP220	Contact ID
Osborne-Hoffman	OH 2000	Contact ID
Bosch	D6600	Contact ID
Silent Knight	9800	Contact ID
Sur-Gard	SG-MLR1, MLR2	Contact ID

SA-232 RS-232 interface

The SA-232 card provides an RS-232 interface with FX panels. It can be used for connecting a printer to the control panel to print system events. The card also can be used for connecting a computer to download a configuration program from the FX-CU to the control panel.

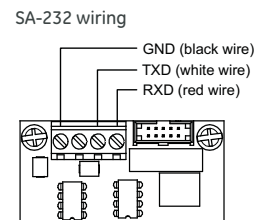

The RS-232 card is installed on the plastic assembly and connects to the main circuit board via a ribbon cable.

SA-232 specifications

Operating voltage	Standard EIA-232
Terminal rating	12 to 18 AWG (0.75 to 2.5 sq mm)
Operating environment	
Temperature	32 to 120°F (0 to 49°C)
Humidity	0 to 93% RH, noncondensing at 90°F (32°C)

SA-CLA Class A Module (FX-64 only)

The SA-CLA card provides Class A capability for NAC wiring. Its terminal block provides the wiring connection for NAC return wiring. The card is required for annunciator Class A wiring even though this wiring does not return to the SA-CLA card. The SA-CLA is compatible with FX-64 control panels only. FX-1000 panels are Class A Ready. The SA-CLA is installed directly to the control panel circuit board using its plastic standoffs and plug connection.

SA-CLA specifications

Operating voltage	24 VFWR
Operating current	3.75 A FWR total at 120/230 VAC 60 Hz 3.0 A FWR total at 230 VAC 50 Hz 2.5 A max per circuit
Circuit impedance	26 ohms, 0.35uF
Terminal rating	12 to 18 AWG (0.75 to 2.5 sq mm)
Operating environment	
Temperature	32 to 120°F (0 to 49°C)
Humidity	0 to 93% RH, noncondensing at 90°F (32°C)

D16L-Fa LED Display Expander (FX-1000 only)

The D16L-FA LED Display Expander provides LED annunciation for up to 16 zones. It provides two LEDs for each zone. Two D16L-FA LED display expanders can be installed in each FX-1000 panel.

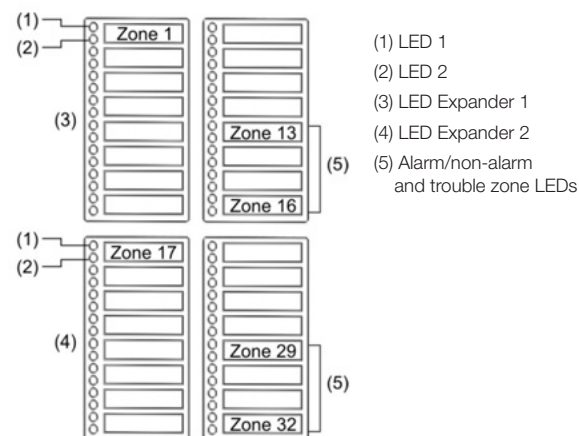

Specifications

	FX-64	FX-1000
Device loops	1 loop Class B or Class A (Styles 4, 6, 7) supporting up to 64 device addresses (any combination of detectors and modules) Maximum T-taps: 63 (each device can be on its own branch)	1 loop, expandable to 4, Class A or B (Styles 4, 6, 7), each loop supporting up to 250 device addresses (125 detectors and 125 modules max.). Addresses 1 to 125 are for detectors and addresses 126 to 250 are for modules Maximum T-taps/loop: 124
Notification appliance circuits	2 Class B (Style Y), Class A (Style Z) optional 3.75 A FWR total at 120/230 VAC 60 Hz 3.0 A FWR total at 230 VAC 50 Hz 2.5 A FWR each max. per circuit	4 Class B (Style Y) or 2 Class A (Style Z) 6.0 A FWR total at 120/230 VAC 60 Hz 5.0 A FWR total at 230 VAC 50 Hz 2.5 A FWR each max. per circuit
Primary power	120 VAC, 60 Hz, 1.3 A max. 230 VAC, 50-60 Hz, 0.62 A max.	120 VAC, 60 Hz, 2.0 A max. 230 VAC, 50-60 Hz, 0.97 A max.
Base panel current standby	155 mA	172 mA
Base panel current alarm	204 mA	267 mA
Input zones	16 max.	32 max.
Remote annunciator	8 drops max., RS-485 Class B, Class A is optional Data line length: 4,000 ft. (1,219 m)	8 drops max., RS-485 Class A or B Data line length: 4,000 ft. (1,219 m)

Specifications, FX-64 and FX-1000

Operating voltage	24 VDC panel	Trouble contact	Form C 24 VDC at 1 A (resistive load)
Auxiliary power output circuit	Aux power 1: 500 mA, 24 VDC Aux power 2: 500 mA, 24 VDC (1 A possible if you reduce total available NAC power by 500 mA) Output: 28.3 to 21.9 VDC, special application <i>Note: For a list of compatible devices, see the FX-64 and FX-1000 Series Compatibility List (P/N 3102355-EN)</i>	Supervisory contact	Form A N.O. 24 VDC at 1 A (resistive load)
Loop circuit	Maximum loop resistance: 66 Ω Maximum loop capacitance: 0.5 μ F Communication line voltage: Maximum 20.6 V peak-to-peak Operating current (fully loaded loop) Stand by: 55 mA/45 mA Alarm: 125 mA/115 mA (not including two-wire smoke modules) Circuit current: 0.5 A max. Style 4, 6, and 7 wiring Max. resistance between isolators: Limited only by overall wire run lengths 64 isolators maximum per loop (total both isolator bases and modules)	Environmental	Temperature: 0 to 49°C (32 to 120°F) Relative humidity: 0 to 93% noncondensing
Ground fault impedance	0 to 5 k Ω	Terminal rating	All terminals rated for 12 to 18 AWG (0.75 to 2.5 mm ²)
Alarm contact	Form C N.O. 24 VDC at 1 A (resistive load)	Batteries	Type: Sealed lead acid Voltage: 24 VDC Charging current: 2.47 A max. Amp hour capacity: 26 Ah Standby operation: 24 hour or 60 hour Placement: Up to two 10 Ah batteries will fit in the FX-64 control panel cabinet and two 18 Ah batteries will fit in the FX-1000 control panel cabinet. If larger batteries are required, use an Kidde battery cabinet.
		SA-DACT dialer	Phone line type: One or two loop-start lines on a public, switched network Phone line connector: RJ-31/38X (C31/38X) Communication formats: Contact ID (SIA DC-05) Operating current Standby/Alarm: 41 mA Max.: 100 mA FCC registration number: GESAL01BSADACT Industry Canada Registration number: 3944A-SADACT Ringer equivalence number: 0.1B

Ordering Information

Part	Description
FX Fire Alarm Systems	
FX-1000D	Four loop system with one 250-point loop installed, 1,000 point capacity max., includes a two-line dialer, four NACs. Red door, surface mount.
FX-1000	Four loop system with one 250-point loop installed, 1,000 point capacity max. Four NACs, red door, surface mount. Order dialer separately.
SA-TRIM2	FX-1000 Flush mount trim, black.
FX-64RD	One loop system with 64-points capacity, includes a two-line dialer, two NACs. Red door, surface mount enclosure.
FX-64R	One loop system with 64-point capacity. Two NACs, red door, surface mount enclosure. Order dialer separately.
SA-TRIM1	FX-64 Flush mount trim, black
FX-64-RE	Replacement Electronics, comes with one 64-point loop
FX-1000-RE	Replacement Electronics, comes with one 250-point loop, expandable to four loops

More...



Technology that saves lives

Contact us...

Email: kidde.fire@fs.utc.com
 Web: kidde.com/engineeredsystems

1016 Corporate Park Drive
 Mebane, NC 27302

Kidde is a registered mark in the United States and other countries.

© 2018 Walter Kidde Portable Equipment.
 All rights reserved.

International Models

FX-64RF	One loop system with 64-point capacity, two NACs, Red door, Surface Mount Enclosure ,110V, French Canada
FX-64R-PG	One loop system with 64-point capacity, two NACs, Red door, Surface Mount Enclosure ,110V, Portuguese
FX-64R-SP	One loop system with 64-point capacity, two NACs, Red door, Surface Mount Enclosure ,110V, Spanish
FX-64R-2	One loop system with 64-point capacity, two NACs, Red door, Surface Mount Enclosure, 230V
FX-64R-2-PG	One loop system with 64-point capacity, two NACs, Red door, Surface Mount Enclosure ,230V, Portuguese
FX-64R-2-SP	One loop system with 64-point capacity, two NACs, Red door, Surface Mount Enclosure ,230V, Spanish
FX-1000F	Four loop system with one 250-point loop installed, 1,000 point capacity max. Four NACs, Red door, Surface Mount Enclosure, 110V, French Canada
FX-1000-CA	Four loop system with one 250-point loop installed, 1,000 point capacity max. Four NACs, Red door, Surface Mount Enclosure, 110V, Canada
FX-1000-PG	Four loop system with one 250-point loop installed, 1,000 point capacity max. Four NACs, Red door, Surface Mount Enclosure, 110V, Portuguese
FX-1000-SP	Four loop system with one 250-point loop installed, 1,000 point capacity max. Four NACs, Red door, Surface Mount Enclosure, 110V, Spanish
FX-1000-2	Four loop system with one 250-point loop installed, 1,000 point capacity max. Four NACs, Red door, Surface Mount Enclosure, 230V
FX-1000-2-PG	Four loop system with one 250-point loop installed, 1,000 point capacity max. Four NACs, Red door, Surface Mount Enclosure, 230V, Portuguese
FX-1000-2-SP	Four loop system with one 250-point loop installed, 1,000 point capacity max. Four NACs, Red door, Surface Mount Enclosure, 230V, Spanish
FX-1000-RE-F	Replacement Electronics, 1 Loop std expandable to 4, FX, French
FX-1000-RE-PG	Replacement Electronics, 1 Loop std expandable to 4, FX, Portuguese
FX-1000-RE-SP	Replacement Electronics, 1 Loop std expandable to 4, FX, Spanish
FX-64-RE-F	Replacement Electronics, 1 Loop 64PT, FX, French
FX-64-RE-PG	Replacement Electronics, 1 Loop 64PT, FX, Portuguese
FX-64-RE-SP	Replacement Electronics, 1 Loop 64PT, FX, Spanish

Option Cards

FX-SLC1	Expansion module, one 250-device loop.
FX-SLC2	Expansion module, two 250-device loops, 500 devices total.
RZ116-2RS	Remote Zone Interface Module. Sixteen Class B Initiating Device Circuits and two Class B Supervised Output Circuits. Mounting bracket included.
SA-DACT	Dual Line Dialer/Modem, supports Contact ID, mounts in cabinet on base plate.
SA-232	RS-232 Serial Port for connection to printers & computers, mounts in cabinet.
SA-ETH	Ethernet Port, Slave, mounts in cabinet on base plate.
SA-CLA	Class A adapter module. Provides Class A capacity on NACs. Mounts in cabinet on main board. FX-64 systems only.
D16L-FA	LED Annunciator Module, 16 groups, 2 LEDs per group with insertable labeling. Mounts in cabinet on FX-1000 systems only.

Accessories

CTM	City Tie Module. Mounts in 2-gang electric box. Provides connection to a local energy fire alarm box.
MFC-A	Multifunction Fire Cabinet, 8" x 14" x 3.5" - RED.
MIR-PRT/S	System printer
BC-1	Battery Cabinet. 14.0" x 18.25" x 7.25". Holds two 12V24A batteries.
BC-1R	Battery Cabinet - Red. 14.0" x 18.25" x 7.25". Holds two 12V24A batteries.
BC-1EQ	Seismic hardening Kit for FX series panels. Includes battery hardening for BC-1 enclosure and components to harden panel internal components.

Programming Tools

FX-CU	FX Series configuration and diagnostics utility.
260097	RS232 cable, 4 conductor, DB9 PC interface