



**AIR PRODUCTS AND CONTROLS INC.**  
**INSTALLATION AND MAINTENANCE INSTRUCTIONS**  
**FOR SM-501 SERIES DUCT SMOKE DETECTORS**

**SM-501-N** 4-Wire, Ionization Type  
**SM-501-P** 4-Wire, Photoelectric Type

**PRODUCT OVERVIEW**

**PRODUCT APPLICATION**

SM-501 Series duct smoke detectors provide early detection of smoke and products of combustion present in air moving through an HVAC duct supply, return, or both in commercial, industrial, and residential applications. These devices are designed to prevent the recirculation of smoke in areas by the air handling system's fans, and blowers. Complete systems may be shut down in the event of smoke detection.

**⚠ NOTE:** For the correct installation of a duct smoke unit, please refer to the NFPA 72 (National Fire Alarm Code), NFPA 90A (Standard for Installation of Air Conditioning and Ventilation Systems), NFPA 92A (Recommended Practice for Smoke Control Systems.), NFPA 5000 (Building Construction and Safety Code), IMC (International Mechanical Code), and IFC (International Fire Code).

This detector is not intended for open area protection nor should it be used for early warning detection or replace a regular fire detection system.

**PRODUCT DESCRIPTION**

The SM-501 Series smoke detector is fitted with a mounting base that will accept an ionization smoke detector head model 55000-225APO (or 55000-250APO) or photoelectric smoke detector head model 55000-328APO (or 55000-350APO). The duct unit supports two sets of form "C" alarm contacts and one form "C" trouble contact. The trouble contact supervises the presence of the input power and removal of the detector head.

**⚠ THE TROUBLE CONTACTS (TERMINALS 13-14-15) ARE SHOWN IN THE NON-ENERGIZED CONDITION. IN NORMAL OPERATION, CONTACTS WILL BE REVERSED.**

The trouble contacts **will not** operate in the event of a smoke alarm. The SM-501 Series duct detector will operate from various input voltage sources; namely 24VAC, 24VDC, 115VAC and 230VAC.

**SAMPLING TUBES**

The operating principle of a duct detector is based on the Venturi effect. Two tubes extend into the HVAC duct. Air flowing through the duct is forced into the air intake (inlet) tube via the air intake holes, (facing the airflow) and passes over the detector head. The air will be drawn out via the exhaust tube back into the HVAC duct. (A 7" exhaust tube is provided in the installation kit.) When the concentration of smoke particles suspended in the air stream reach the alarm threshold of the detector head, the unit will go into alarm.

The duct smoke detector units are designed to operate in duct widths from 6" to 10' wide with an air velocity between 500 to 4,000 feet per minute. To verify correct installation, the pressure differential between

the sampling (high side) and exhaust (low side) tubes should be measured using a Magnehelic pressure gauge or equivalent. An acceptable reading is between 0.01 and 1.2 inches of water.

To minimize the impact of air turbulence and stratification on performance, a duct smoke detector should be located as far as possible downstream from any obstruction (i.e. deflector plates, elbows, dampers, etc.). In all situations, confirmation of velocity and pressure differential within specifications is required.

**REMOTE ACCESSORIES**

Audible and visual alarm indicators, remote status indicators, and remote reset/test switches can be accommodated by the SM-501 Series duct units by connecting to DC voltage output terminals 16 through 21. These terminals are not supervised and the voltage/current will only be present when the detector unit is in alarm. The remote pilot (green) LED will be permanently illuminated when connected to the output terminals as long as input power and detector head are present.

**SM-501 AT-A-GLANCE**

**MODEL NUMBER:**

SM-501-N 4-Wire Ionization Duct Smoke Detector  
SM-501-P 4-Wire Photoelectric Duct Smoke Detector

**DETECTOR HEAD MODEL NUMBER:**

Ionization Detector Head: **55000-225APO**  
Photoelectric Detector Head: **55000-328APO**

**POWER REQUIREMENTS:**

STANDBY CURRENT		ALARM CURRENT	
24VAC	35.0mA	24VAC	74.0mA
24VDC	15.0mA	24VDC	56.0mA
115VAC	25.0mA	115VAC	32.0mA
230VAC	12.0mA	230VAC	16.0mA

**RELAY CONTACT RATINGS:**

Alarm contacts: 2 Sets form "C" rated at 10A @ 115VAC resistive  
 Trouble contacts: 1 Set form "C" rated at 10A @ 115VAC resistive  
 Air velocity: 500 to 4,000ft/min.  
 Ambient temperature: SM-501-N: 32°F to 158°F (0°C to 70°C)  
 SM-501-P: 32°F to 140°F (0°C to 60°C)  
 Humidity: 10% to 85% RH Non-Condensing/Non-Freezing  
 Material: 18GA steel back box, clear plastic cover (Makrolon 94V-0)  
 Finish: Gray paint on black box  
 Dimensions: 9 1/8" L X 7 1/4" W X 2 1/4" H  
 Max. net wt.: 3 1/2 lbs.  
 Radioactive element: SM-501-N (Ionization) - Americium 241, 0.9 micro curie.  
**Do not expose to corrosive atmospheres.**

# MECHANICAL INSTALLATION

## LOCATION PREREQUISITES

This guideline contains general information on duct smoke detector installation, but does not preclude the NFPA and/or ICC documents listed. Air Products and Controls assumes no responsibility for improperly installed duct detectors. To determine the correct installation position for an SM-501 Series duct smoke detector, the following factors must be considered.

- 1) A uniform non-turbulent (laminar) airflow between 500 ft/min. to 4,000 ft/min. must be present in the HVAC duct. To determine duct velocities, examine the engineering specifications that define the expected velocities or use an Anor model 6000AP velocity meter (or equivalent).
- 2) To minimize the impact of air turbulence and stratification on performance, a duct smoke detector should be located as far as possible downstream from any obstruction (i.e. deflector plates, elbows, dampers, etc.). In all situations, confirmation of velocity and pressure differential within specifications is required.

The pressure differential between the input sampling (high pressure) tube and exhaust (low pressure) tube for the SM-501 Series smoke duct detector should be greater than 0.01 inches of water and less than 1.2 inches of water.

- 3) Identify a code compliant location (supply or return side, or both) for the installation of the duct unit that will permit easy access for viewing and serviceability.
- 4) When installing on the return side, install duct units prior to the air being exhausted from the building or diluted with outside "fresh" air.
- 5) When installing duct smoke units downstream of filters, fires occurring in the filters will be detected, but if the filters become blocked, insufficient air flow through the duct unit will prevent the correct operation of the duct detector. Duct units installed in the supply air side may monitor upstream equipment and/or filters.
- 6) Where possible, install duct detectors upstream of air humidifiers and downstream of dehumidifiers.
- 7) To prevent false alarms, the duct detector should not be mounted in areas of extreme high or low temperatures, in areas where high humidity exists, or in areas where the duct may contain gases or excessive dust.

## SAMPLING TUBE ASSEMBLY

Sampling tubes are to be ordered separately in one of four standard lengths.

- STS-1.0** For duct widths of 6" TO 1.0'
- STS-2.5** For duct widths of 1.0' TO 2.5'
- STS-5.0** For duct widths of 2.5' TO 5.0'
- STS-10.0** For duct widths of 5.0' TO 10.0'

Standard sampling tubes are steel tubes with air intake holes drilled the entire length of the tube. These tubes must be cut to length and should span the entire width of the duct. Sampling tubes over 3.0' must be supported on the opposite side of the duct.

To ensure the correct operation of the sensing tube, the red end cap (red stopper in installation kit) must be inserted in the end of the air intake sampling tube. For custom duct widths, always use the next longest standard size and cut down to the exact requirement.

Once the airflow direction has been determined, insert the inlet and exhaust tubes into the sampling tube connectors fitted to the back of the duct smoke detector which are equipped with set screws. These connectors will allow the tubes to be correctly orientated and secured by tightening the set screw. Ensure air intake sampling tube is positioned so that the inlet holes are directly facing the airflow.

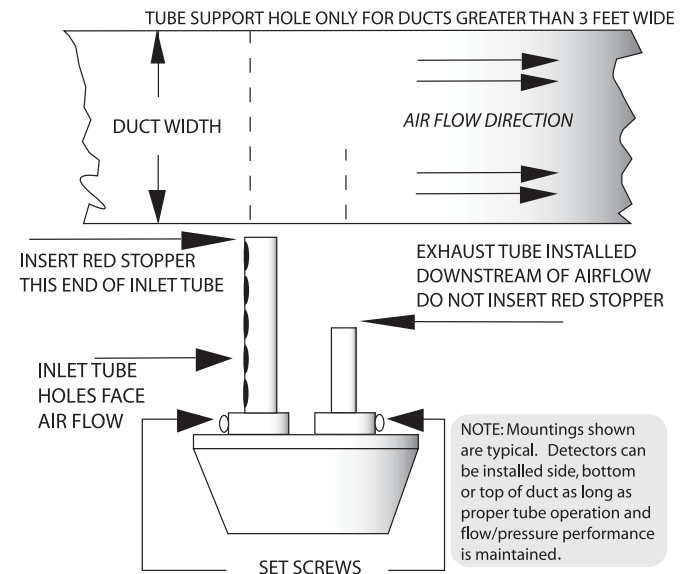

## DUCT PREPARATION

Remove mounting template from the installation kit. Remove paper backing from the mounting template and affix it to the duct at the desired location. Using the template as a guide, drill (4) mounting holes (3/32" diam.) for the # 12 X 1/2" sheet metal screws packaged in the installation kit. Drill or punch (2) 1 3/8" holes for inlet sampling and exhaust tubes, using the template as a guide. Clean all holes.

## MOUNTING

After securing the sampling and exhaust tubes to the duct smoke unit, (or initially placing the tubes through the 1 3/8" holes drilled or punched in the HVAC duct to accept the inlet sampling and exhaust tubes and then attaching them to the duct unit), hold the duct unit assembly in position and use (4) # 12 X 1/2" sheet metal screws (packaged in the installation kit) to secure the duct smoke detector to the HVAC duct sheet metal.

## AIR SAMPLING VERIFICATION

To ensure correct operation of the duct unit use a Magnehelic differential pressure gauge, Dwyer 2000 or 4000 Series (or equivalent) to determine the differential pressure between the inlet (high side) and exhaust (low side) tubes. The differential pressure between the two tubes should be greater than 0.01 inches of water and less than 1.2 inches of water.

# ELECTRICAL INSTALLATION

## POWER CONNECTIONS

Prior to connecting input power to the duct unit, determine the correct input voltage/ current availability and ensure it is connected to the correct terminals.

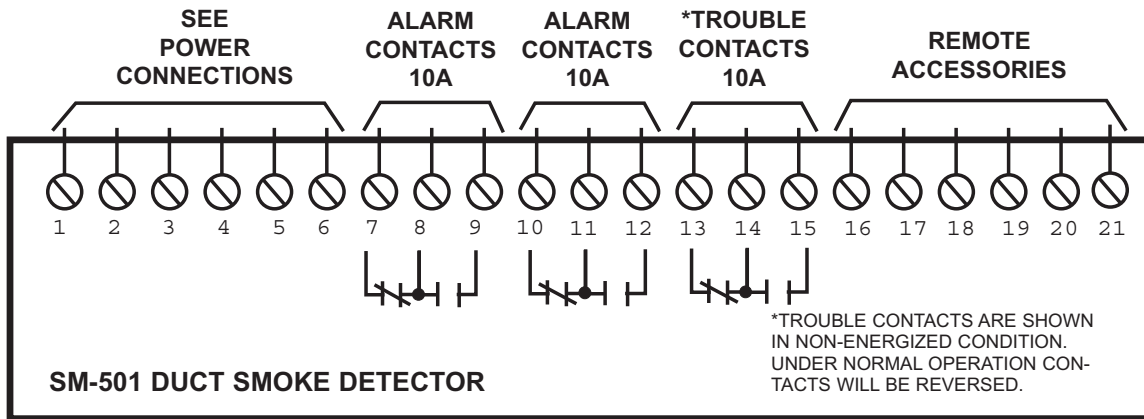
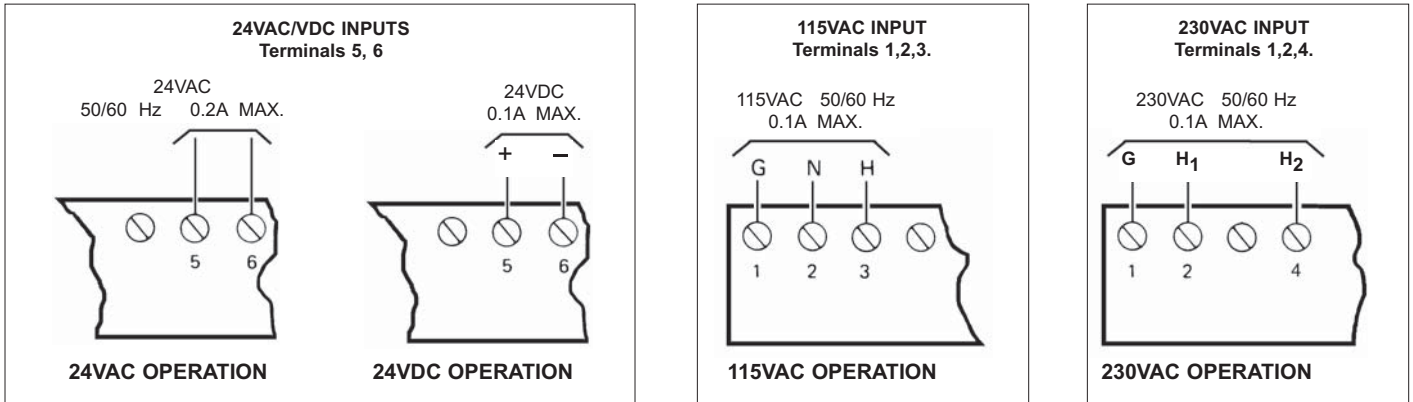

## WIRING

**CAUTION:** For terminals 7-15 do not use looped wire under terminals. Break wire run to provide for proper supervision of connections.

With detector head removed, connect one of the appropriate dedicated power sources to the applicable terminals (see above). Replace detector head and the unit will be energized. The green pilot LED will be illuminated, and when pressing the test/reset button, the red alarm LED will be illuminated. This test confirms the correct basic operation of the duct smoke unit, excluding the detector head (see functional testing).

In the event of a fire alarm, certain equipment may be required to be shut down. For example, shut down may be achieved by interrupting the fan supply source to that particular piece of equipment when wired as indicated below.

### EXAMPLE:

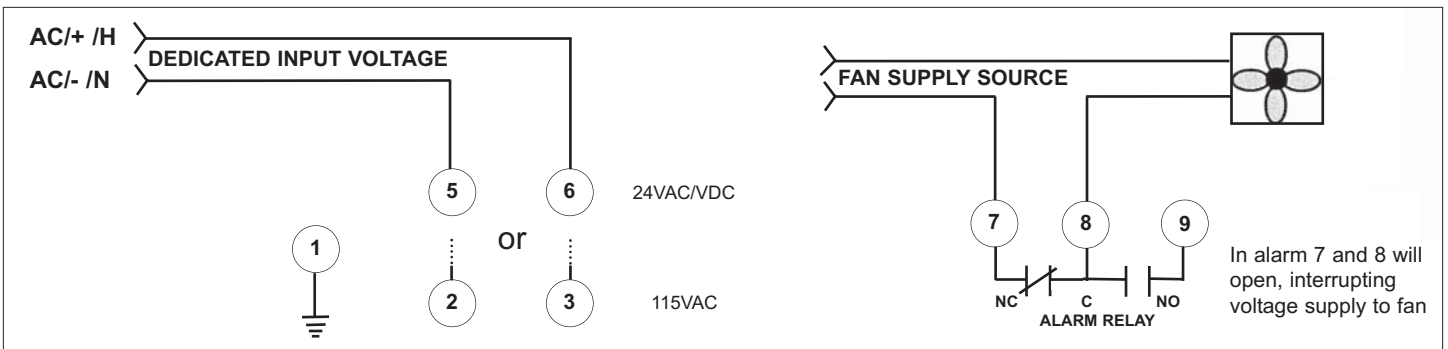

## FIRE ALARM CONTROL PANEL WIRING

**SAMPLE CONTROL PANEL WIRING - STYLE "D" / CLASS "A" IDC** (Supervised - A fault condition will not inhibit an alarm response)

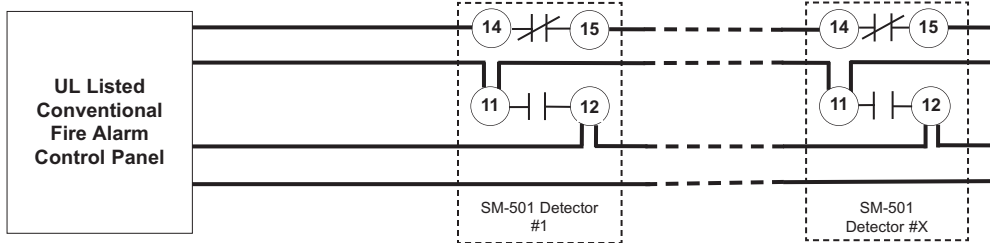

**SAMPLE CONTROL PANEL WIRING - STYLE "B" / CLASS "B" IDC** (Supervised - A fault condition will not inhibit an alarm response)

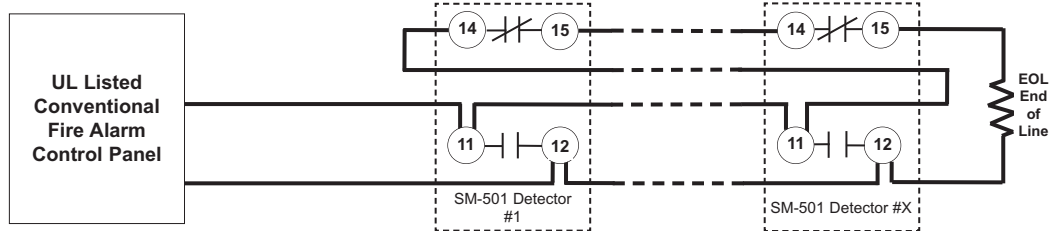

### MSR REMOTE ACCESSORY WIRING

A jumper wire must be placed between Terminals 14 and 18.

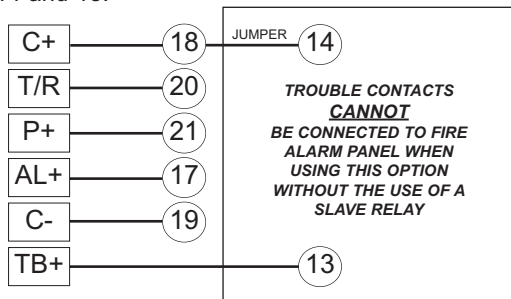

### INTERCONNECTION WIRING FOR COMMON FUNCTIONS

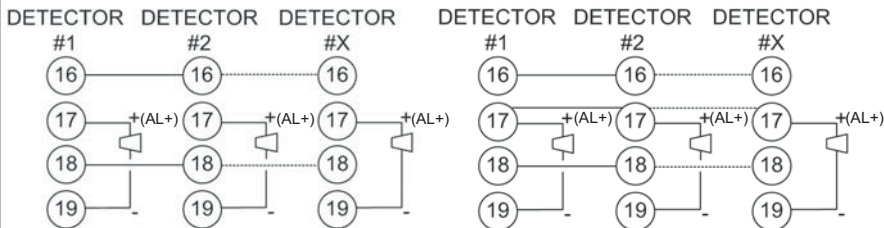

All alarm relays operate with single alarm. Individual horn/strobe units operate on alarmed detector only. 30 detectors max.

All alarm relays operate with single alarm. All horn/strobe units operate on any single alarm. 15 detectors max.

### MS REMOTE ACCESSORY WIRING

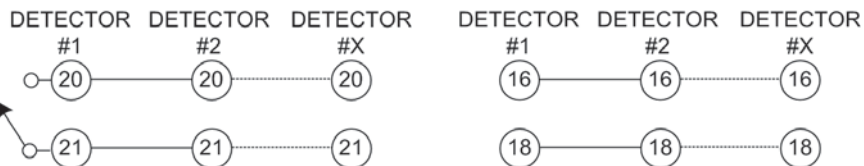
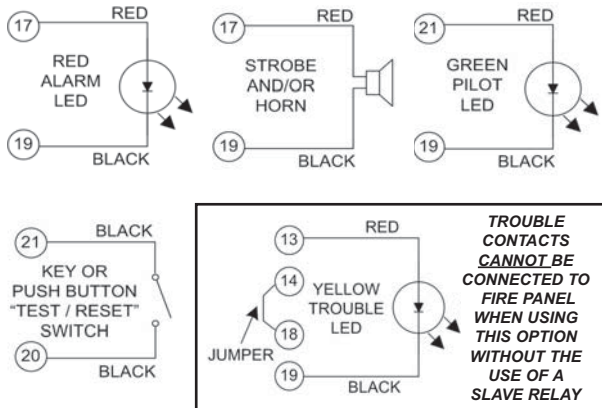

Common test/reset. 30 detectors max. (Use normally open test/reset switch)

All alarm relays operate with single alarm. 30 detectors max.

# TESTING PROCEDURES

## OPERATIONAL TESTING

To determine the correct operation of the SM-501 Series duct smoke detector, ensure input power is connected and the green pilot LED is illuminated.

The LED on the detector head of both the ionization and photoelectric models (55000-225APO or 55000-328APO) will flash while the unit is in standby mode. The LED on the detector head of both the ionization and photoelectric models (55000-250APO or 55000-350APO) will not flash while the unit is in the standby mode. The LED on all the above detector heads will be permanently illuminated when smoke is detected and the head is in alarm.

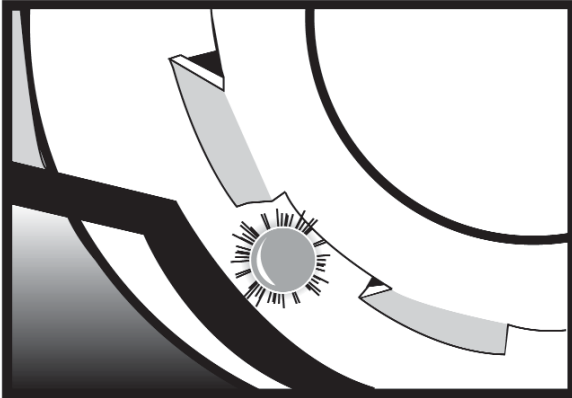

Above: The LED will be permanently illuminated when the unit is in alarm.

With the air handling unit shut down (not connected), and the clear cover removed, press and hold the test/reset button on the SM-501. The red alarm LED on the circuit board will be illuminated and the alarm relay outputs will change state. Using a multimeter set to OHMS (or continuity buzzer function on the meter) place the meter probes on the following terminals, and ensure the contacts are closed (continuity) (8-9) and (11-12). When releasing the test/reset button these contacts will open.

The trouble contacts 13, 14, 15 on the SM-501 detector will not change state in the event of a fire alarm, operational, or functional testing. The trouble contacts can be tested by rotating the smoke detector head counter-clockwise and removing the detector head. This action will extinguish the green pilot LED and cause the trouble contacts to change state, (13-14) will be closed (continuity) and (14-15) will be open circuit. Replacing the detector head and rotating it clockwise until it locks, will cause the green pilot LED to be illuminated and the unit will be operational, terminals (13-14) will be an open circuit and (14-15) will be closed (continuity).

## FUNCTIONAL TESTING

Once operational testing is concluded the unit requires functional testing to determine the correct operation of the detector head.

With the clear cover removed, air handling unit shut down, and using the Air Products and Controls aerosol test smoke gas part number TG-1000, spray the test gas directly at the detector head from a distance of 12 inches for 2 seconds.

**⚠ CAUTION: SPRAYING FROM A DISTANCE CLOSER THAN 12 INCHES MAY CAUSE DETECTOR CONTAMINATION.**

After 15 to 20 seconds the detector head will go into alarm, illuminating the detector head LED and causing the duct unit functions to operate, alarm relays will change state, and the alarm related remote accessories, if attached, will function.

If no test gas is available to conduct functional testing, light a piece of clothesline (rope) and blow the flame out, hold the smoldering rope 3" from the detector head and lightly blow across the smoldering area towards the detector head, the alarm indicator should illuminate within one minute.

Should additional testing also be required for simulated fire conditions, smoke bombs placed in the duct may not be suited for the particular detector head (photoelectric or ionization) selected and installed. Consult the smoke bomb data for proper use and compatibility with detector type.

S65A ionization detector head 55000-225APO and S60A ionization detector head 55000-250APO utilize a radioactive source as its means of detection and will detect smoke particles of between .1 and 1 micron in size.

S65A photoelectric detector head 55000-328APO and S60A photoelectric detector head 55000-350APO operate on the principle of light scatter and will detect smoke particles of between 1 and 10 microns in size.

When purchasing smoke bombs for additional required functional testing, ensure smoke particle sizes comply with the criteria as described above.

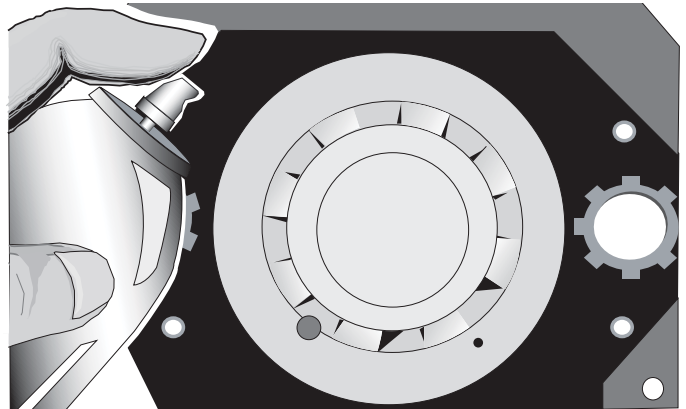

Above: For factory recommended functional testing, spray the proper test gas directly at the detector head from a distance of 12 inches for 2 seconds.

## MAINTENANCE

Each installation location must be assessed on its own merits. If the protected area is of a very dirty nature then the SM-501 Duct unit(s) will have to be checked and cleaned on a quarterly basis or when cleaning is required.

As a guideline the smoke detector head should be cleaned every six months or as required. The best methods of cleaning are to vacuum the detector head thoroughly or to blow the detector head out using clean, dry compressed air.

Do not use chemicals or non-conforming air to clean the detector head housing as this could contaminate the detector head and damage the casing.

Sensing tubes must be inspected and cleaned in accordance with the schedule as determined above, to allow the free flow of air through both inlet and exhaust tubes.

Consult your local code and AHJ requirements for required maintenance schedules.



AIR PRODUCTS AND CONTROLS INC.  
25 Corporate Drive Auburn Hills, MI 48326 USA  
Telephone: (248) 332-3900 www.ap-c.com

## AVAILABLE ACCESSORIES FOR USE WITH SM-501 SERIES DUCT SMOKE DETECTORS

### MSR- SERIES REMOTE ACCESSORIES

Visual Indicators: Alarm, Pilot, Trouble  
Buzzer: Programmable for Alarm and Trouble  
Buzzer Silence: Visual Notification and Ringback  
Detector Test/Reset: Key Operated  
LED/Buzzer Test: Push-Button Operated  
MSR-100R/W White Face Plate  
MSR-100R/R Red Face Plate  
MSR-100R/S Stainless Steel Face Plate  
MSR-100RS/W/C White Face Plate; Strobe with Clear Lens  
MSR-100RS/W/O White Face Plate; Strobe with Opaque Lens  
MSR-100RS/R/C Red Face Plate; Strobe with Clear Lens  
MSR-100RS/R/O Red Face Plate; Strobe with Opaque Lens  
MSR-100RS/S/C Stainless Steel Face Plate; Strobe with Clear Lens  
MSR-100RS/S/O Stainless Steel Face Plate; Strobe with Opaque Lens

### MS- and SHP- SERIES REMOTE ACCESSORIES

MS-RA Remote Alarm  
MS-RA/R Remote Alarm, push button Test/Reset Switch  
MS-RA/P/R Remote Alarm, Pilot, push-button Test/Reset Switch  
MS-KAR Remote Alarm, key-operated Test/Switch  
MS-KAP/R Remote Alarm, Pilot, key-operated Test/Reset Switch  
MS-RA/P Remote Alarm, Pilot  
MS-RH Remote Alarm Horn  
MS-RH/KAP/R Remote Alarm, Pilot, Horn, key-operated Test/Reset Switch  
MS-RH/PIA Remote Alarm, Pilot, Horn  
MS-RH/KAP/AT Remote Alarm, Trouble, Pilot, Horn, key-operated Test/Reset Switch  
MS-RA/P/T Remote Pilot, Trouble  
MS-RA/P/T/P Remote Pilot, Trouble, push-button Test/Reset Switch  
MS-KAP/R/T Remote Pilot, Trouble, key-operated Test/Reset Switch  
MS-RD Remote Alarm  
MS-F/T Remote Trouble  
SHP24-1575R Horn/Strobe, red housing, clear cover  
SHP24-1575O Horn/Strobe, white housing, opaque cover  
SHP24-1575W Horn/Strobe, white housing, clear cover

### SMOKE TEST GAS

TG-1000 Solo Aerosol Test Gas

### SAMPLING TUBES

STS-1.0 For duct widths of 6" TO 1.0'  
STS-2.5 For duct widths of 1.0' TO 3.0'  
STS-5.0 For duct widths of 3.0' TO 5.0'  
STS-10.0 For duct widths of 5.0' TO 10.0'-

### WEATHERPROOF ENCLOSURES

WP-1 Weatherproof Enclosure

### REPLACEMENT SMOKE DETECTOR HEADS

55000-225APO S65 Ionization Detector Replacement Head  
55000-328APO S65 Photoelectric Detector Replacement Head

### POWER SUPPLIES

T-PB 202-1 24VAC @ 4.0A Class I Power Supply  
T-PB 202-0 24VAC @ 4.0A Class I Power Supply  
T-PB 303-1 24VAC @ 3.0A Class II Power Supply  
T-PB 303-0 24VAC @ 3.0A Class II Power Supply

AIR PRODUCTS  
AND  
CONTROLS

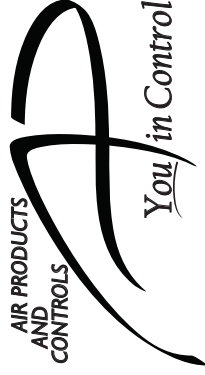

SM-501 SERIES  
DUCT SMOKE DETECTORS

## INSTALLATION AND MAINTENANCE INSTRUCTIONS

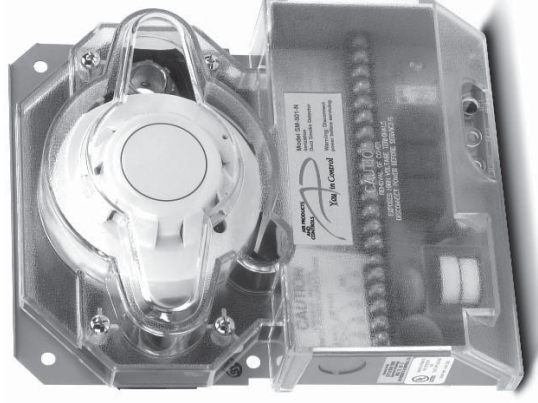

**SM-501-N** Ionization Type, 4-Wire Duct Smoke Detector  
**SM-501-P** Photoelectric Type, 4-Wire Duct Smoke Detector

**NOTICE:** The information contained in this document is the most current available at the time of shipment of accompanying product, and is subject to change without notice. Future references should always be made to the most current revision of this document. The information contained in all this document should be considered before installing or using the product. Any example applications shown are subject to the most current enforced local/national codes, standards, approvals, certifications, and/or the authority having jurisdiction. All of these resources, as well as the specific manufacturer of any shown or mentioned related equipment, should be consulted prior to any implementation. For further information or assistance concerning this product, contact Air Products and Controls Inc. Air Products and Controls Inc. reserves the right to change any and all documentation without notice.

© Air Products and Controls Inc. 2007

**A COPY OF THESE INSTRUCTIONS SHOULD BE LEFT WITH THE EQUIPMENT  
UNTIL INSTALLATION BY ALL TRADES IS FULLY COMPLETE. FOLLOWING FINAL  
INSPECTION, A COPY SHOULD BE LEFT WITH THE OWNER/USER.**

FOR TECHNICAL SUPPORT CALL 888-332-2241 OR 248-332-3900