

12 Clintonville Road, Northford, CT 06472  
203.484.7161; Fax: 203.484.7118  
www.silentknight.com

## SK-Control Supervised Control Module

### SPECIFICATIONS

Normal Operating Voltage:	15 to 32 VDC
Maximum Current Draw:	6.5 mA (LED on)
Average Operating Current:	375µA (LED flashing - in group poll mode) 350µA (LED flashing - in direct poll mode) 485µA Max. (LED flashing, NAC shorted)
Maximum NAC Line Loss:	4 VDC
Reg. Ext. Supply Voltage:	(between Terminals T3 and T4)
Maximum (NAC):	Regulated 24VDC
Drain on External Supply:	1.7 mA Maximum (using 24 VDC supply)
Max. NAC Current Ratings:	For class B wiring system, 3A; For class A wiring system, 2A
Temperature Range:	32°F to 120°F (0°C to 49°C)
Humidity:	10% to 93% Non-condensing
Dimensions:	4 <sup>1</sup> / <sub>2</sub> " H x 4" W x 1 <sup>1</sup> / <sub>4</sub> " D (Mounts to a 4" square by 2 <sup>1</sup> / <sub>8</sub> " deep box.)
Accessories:	SMB500 Electrical Box

### BEFORE INSTALLING

This information is included as a quick reference installation guide. Refer to the control panel installation manual for detailed system information. If the modules will be installed in an existing operational system, inform the operator and local authority that the system will be temporarily out of service. Disconnect power to the control panel before installing the modules.

NOTICE: This manual should be left with the owner/user of this equipment.

### GENERAL DESCRIPTION

SK-Control Supervised Control Modules are intended for use in intelligent, two-wire systems, where the individual address of each module is selected using the built-in rotary switches. This module is used to switch an external power supply to notification appliances. It also supervises the wiring to the connected loads and reports their status to the panel as NORMAL, OPEN, or SHORT CIRCUIT. The SK-Control has two pairs of output termination points available for fault-tolerant wiring and a panel-controlled LED indicator.

### COMPATIBILITY REQUIREMENTS

To ensure proper operation, this module shall be connected to a compatible Silent Knight system control panels only (list available from Silent Knight).

### MOUNTING

The SK-Control mounts directly to 4-inch square electrical boxes (see Figure 2A). The box must have a minimum depth of 2<sup>1</sup>/<sub>8</sub> inches. Surface mounted electrical boxes (SMB500) are available.

### WIRING

NOTE: All wiring must conform to applicable local codes, ordinances, and regulations. When using control modules in nonpower limited applications, UL requirements for the separation of power-limited and nonpower-limited terminals and wiring must be met. The barrier must be inserted into a 4" x 4" x 2<sup>1</sup>/<sub>8</sub>" junction box, and the control module must be placed into the barrier and attached to the junction box (Figure 2A). The power-limited wiring must be placed into the isolated quadrant of the module barrier (Figure 2B).

1. Install module wiring in accordance with the job drawings and appropriate wiring diagrams.
2. Set the address on the module per job drawings.
3. Secure module to electrical box (supplied by installer), as shown in Figure 2A.

IMPORTANT: When using the SK-Control for fire fighter telephone applications, remove Jumper (J1) and discard. The Jumper is located on the back as shown in Figure 1B.

FIGURE 1A. CONTROLS AND INDICATORS:

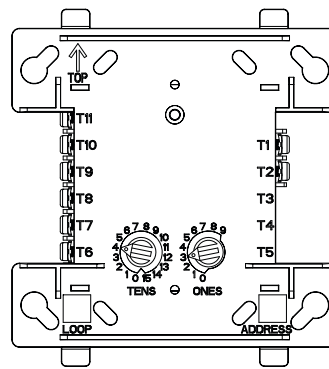

C1059-00

FIGURE 1B. JUMPER LOCATION:

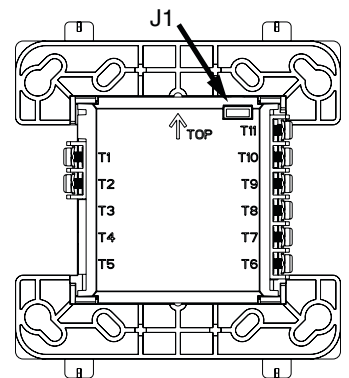

C0910-00

FIGURE 2A. MODULE MOUNTING WITH BARRIER:

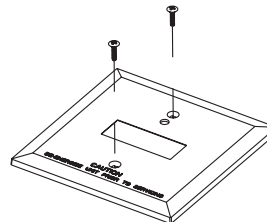
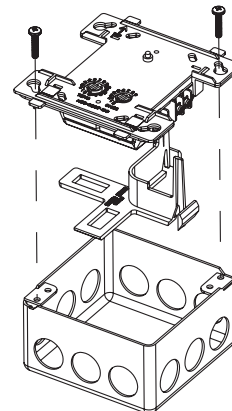
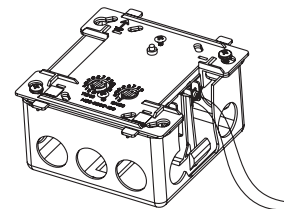
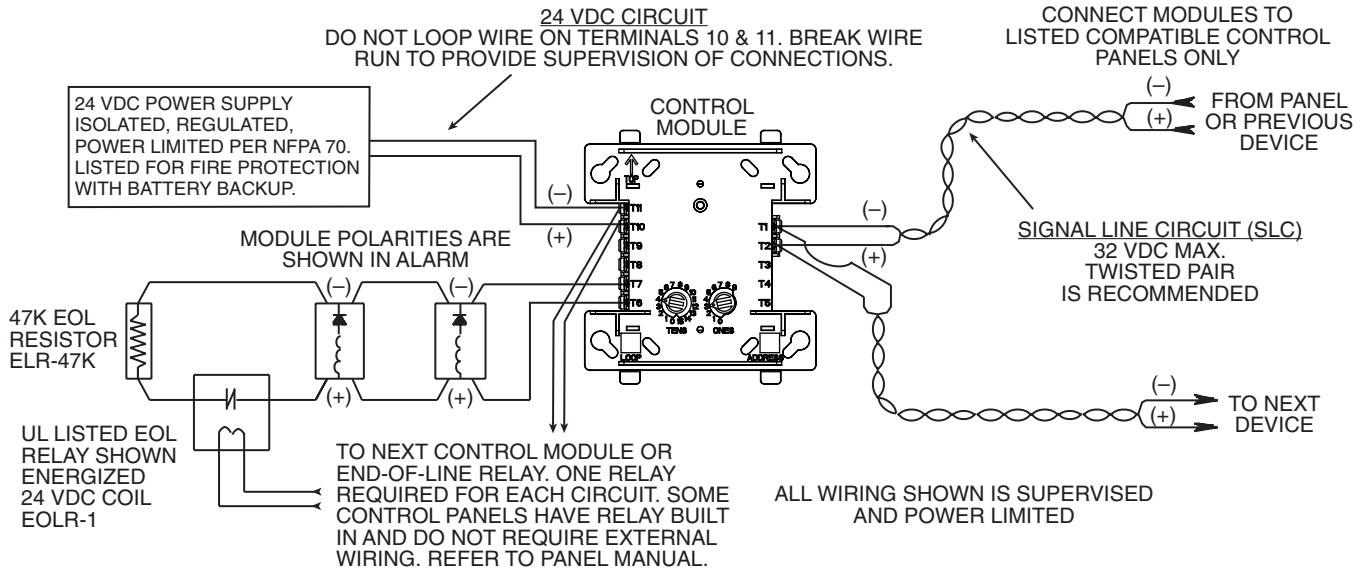

FIGURE 2B:



C1047-00

**FIGURE 3. TYPICAL NOTIFICATION APPLIANCE CIRCUIT CONFIGURATION, NFPA STYLE Y:**



\*NOTE: ANY FAULT IN THE POWER SUPPLY IS LIMITED TO THAT ZONE AND DOES NOT RESULT IN A FAULT IN A SEPARATE ZONE.

C0947-00

**FIGURE 4. TYPICAL FAULT TOLERANT NOTIFICATION APPLIANCE CIRCUIT CONFIGURATION, NFPA STYLE Z:**

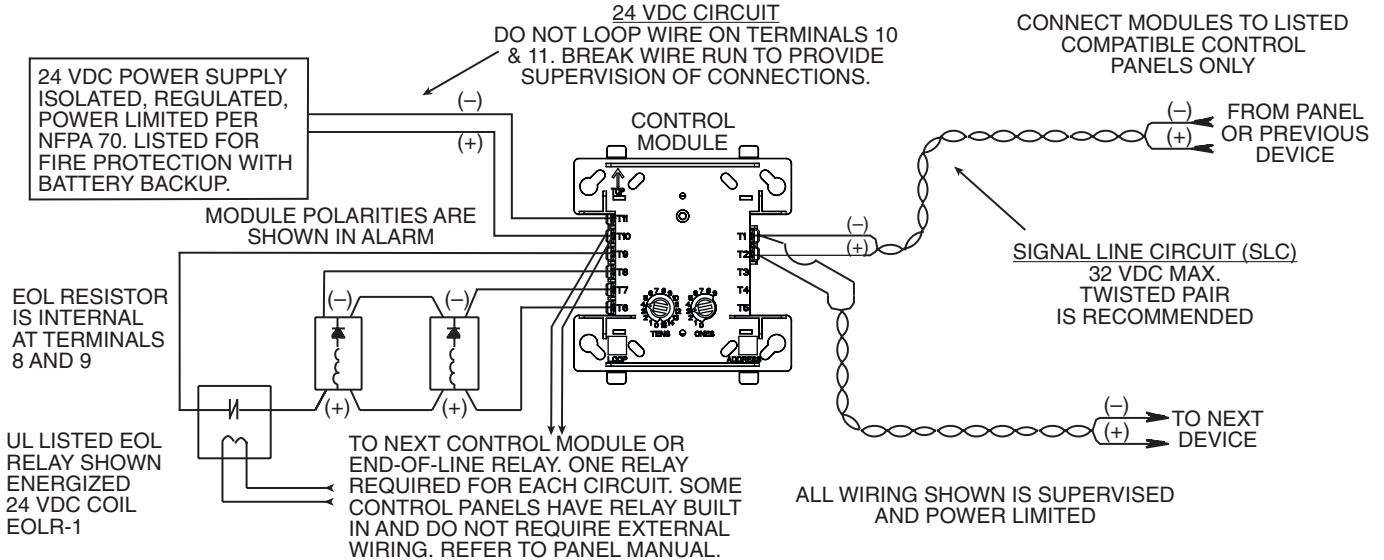

\*NOTE: ANY FAULT IN THE POWER SUPPLY IS LIMITED TO THAT ZONE AND DOES NOT RESULT IN A FAULT IN A SEPARATE ZONE.

C0948-00

**WARNING**

All relay switch contacts are shipped in the standby state (open) state, but may have transferred to the activated (closed) state during shipping. To ensure that the switch contacts are in their correct state, modules must be made to communicate with the panel before connecting circuits controlled by the module.