

50RS-12 Series Miniature 1/4" Recessed Switch Set



50RS-12
Miniature 1/4" Recessed
Switch Set

- Lifetime Warranty
- Colors: White, Brown or Gray
- Standard 12" Leads
- Longer Leads, Zip Cord or Jacketed Cable on Request
- UL and ULC Approved
- Available in Open Loop, Closed Loop and SPDT
- Hermetically Sealed
- Ideal for Thin Framed Doors and Windows
- Ideal in Jobs for which a Regular Size Switch is Too Long
- Plated Contacts Resist Sticking or Freezing
- Switches or Magnets are Available Separately
- Standard Gap 1/4"+
- Wide Gap 1/2"+
- Extra Wide Gap 3/4"+

The GRI 50RS Series is a 1/4" diameter switch designed for applications where a miniature recessed switch set is required. Only .562 inches in length, the switch is able to be recessed in places where a standard switch is too large. The 50RS series is also widely used in the manufacture of alarm screens.



50RS-12
Miniature 1/4" Recessed Switch Set

SUPER MINIATURE 1/4" RECESSED SWITCH SET

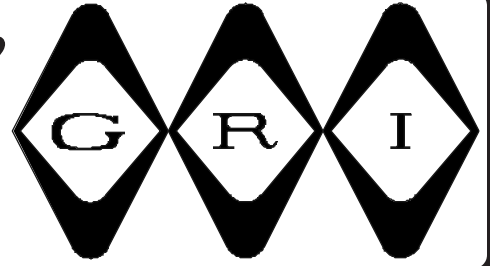

50RS-12 SERIES



- ◆ Just .562" Long, The 50RS-12 Super Mini Is Ideal For Thin Framed Doors & Windows
 - ◆ Open Loop and S.P.D.T. Configurations Are .810" In Length
 - ◆ Recessed Magnetic Contact
 - ◆ Press To Fit
 - ◆ 12" #22AWG Leads
 - ◆ Longer Leads, Zip Cord or Jacketed Cable Upon Request
 - ◆ Hermetically Sealed
 - ◆ Plated Contacts Resist Sticking or Freezing
 - ◆ Built-in E.O.L. Resistors and Diodes Upon Request
 - ◆ Switches and Magnets Available Separately
 - ◆ Colors: White, Brown, Gray
 - ◆ Lifetime Warranty



50RS-12

PART NUMBERS:	Closed Loop	Open Loop	SPDT
Standard Gap 1/4" +	50RS-12	60RS-12	70RS-12
Wide Gap 1/2" +	50RS-12WG	60RS-12WG	70RS-12WG
Extra Wide Gap 3/4" + 70RS-12XWG		50RS-12XWG	60RS-12XWG

GEORGE RISK INDUSTRIES, INC.
G.R.I. PLAZA
KIMBALL, NE 69145



MADE IN U.S.A.

TOLL-FREE 1-800-445-5218
TOLL-FREE 1-800-523-1227
(308) 235-4645
FAX (308) 235-3561
E-MAIL: grisales@megavision.com
WEB SITE: www.grisk.com

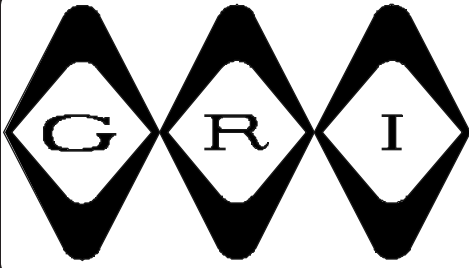

SUPER MINIATURE 1/4" RECESSED SWITCH SET

INSTALLATION APPLICATIONS:

The G.R.I. 50RS series is a 1/4" diameter switch set designed for applications where a miniature recessed is required. Only .562" in length, the switch is able to be recessed in places where a standard switch is too large. The 50RS series is also widely used in the manufacture of alarm screens.

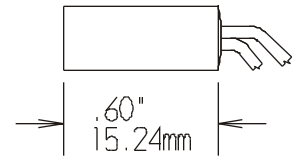
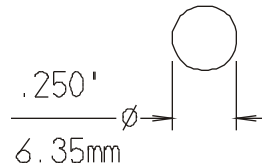

50RS-12

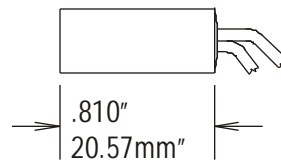
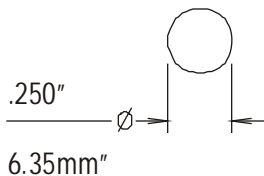

60RS-12/70RS-12

GRI products meet or exceed these minimum general specifications:

PART NUMBER	LOOP TYPE	ELECTRICAL CONFIG.	REED FORM	MAXIMUM INITIAL CONTACT RESISTANCE (Ω)	MAXIMUM CONTACT RATING (W)	MAXIMUM SWITCHING VOLTAGE (VDC)	MAXIMUM SWITCHING CURRENT (A)
50RS-12	CLOSED	N/O	A	.150	10	200	.500
50RS-12WG	CLOSED	N/O	A	.150	10	200	.500
50RS-12XWG	CLOSED	N/O	A	.150	10	200	.500
60RS-12	OPEN	N/C	B	.140	5	175	.250
60RS-12WG	OPEN	N/C	B	.140	5	175	.250
60RS-12XWG	OPEN	N/C	B	.140	5	175	.250
70RS-12	Open/Closed	SPDT	C	.140	5	175	.250
70RS-12WG	Open/Closed	SPDT	C	.140	5	175	.250
70RS-12XWG	Open/Closed	SPDT	C	.140	5	175	.250

WARRANTY:

Lifetime warranty against workmanship, material and factory defects.

CONTACT YOUR G.R.I. DISTRIBUTOR OR CALL:

GEORGE RISK INDUSTRIES, INC.
G.R.I. PLAZA
KIMBALL, NE 69145



MADE IN U.S.A.

TOLL-FREE 1-800-445-5218
TOLL-FREE 1-800-523-1227
(308) 235-4645
FAX (308) 235-3561

E-MAIL: grisales@megavision.com
WEB SITE: www.grisk.com

N SERIES SWITCH SETS



- ◆ Rare Earth Magnets Paired With Press To Fit Contacts
- ◆ Solves Problem Installs ◆ Time Saving Installations
- ◆ Nickel Plated To Protect From Chipping And Corrosion
- ◆ Use MM-600 With A Standard Gap Switch To Attain Wide Gap



N2120-12



N2020-TWG



N20RS-12

G.R.I.'s "Mighty Mag" contacts will assist in resolving the installer's problem of drilling into the new thinner vinyl windows. These rare earth magnets are less than 1/8" high and install fast and easily without worry about damage to the window itself. (Please see the Mighty Mag page in the accessories section of G.R.I.'s full line catalog for dimensions).

G.R.I.'s Mighty Magnets make use of a rare earth alloy which allows the size of the magnet to be significantly reduced while still retaining or improving the gap involved. These rare earth magnets can be mounted with the stainless steel mounting screws provided (MM-400 and MM-600) and/or double stick tape included in the bag, or may be glued into place.

Note: G.R.I. suggests using a silicone or clear nail polish sealant on the surface of installed rare earth magnets to prevent corrosion.

PART NUMBERS:

N120T-12	N2020-T	N2120-12	N50RF-12
N120T-12WG	N2020-TWG	N2120-12WG	N50RF-12WG
N150-12	N20RS-12	N4473	N50RS-12
N150-12WG	N20RS-12WG	N4473WG	N50RS-12WG
N2020-12	N20RS-T	N50R-12	N5065
N2020-12WG	N20RS-TWG	N50R-12WG	

Other possible combinations including Open Loop and S.P.D.T. available or as Switch Only and Magnet Only.

GEORGE RISK INDUSTRIES, INC.
G.R.I. PLAZA
KIMBALL, NE 69145



MADE IN U.S.A.

TOLL-FREE 1-800-445-5218
TOLL-FREE 1-800-523-1227
(308) 235-4645

FAX (308) 235-3561
E-MAIL: grisales@megavision.com
WEB SITE: www.grisk.com



SWITCHES WITH RARE EARTH MAGNETS

Pair Switch with Magnet to get the following gaps:

Switch	Description	MM-25				
		MMR-25	MM-375	MM-10	MM-400	MM-600
S120T-12	3/4" Press Fit/Leads	3/8"+	1"+	Up to 1"	Up to 3/4"	1"+
S150-12	1/2" Press Fit/Leads	1/2"+	1 1/2"+	Up to 1"	3/4"+	1 1/2"+
S2020-12	3/8" Press Fit/Leads	Up to 1/2"	1"+	Up to 1"	1"+	1"+
S2020-T	3/8" Press Fit/Terminals	3/8"+	1"+	Up to 1"	Up to 3/4"	1"+
S20RS-12	3/8" Short Press Fit/Leads	Up to 3/8"	1"+	3/4"+	Up to 3/4"	Up to 1"
S20RS-T	3/8" Short Press Fit/Terminals	3/8"+	1"+	3/4"+	Up to 3/4"	Up to 1"
S2120-12	3/8" Ribbed Press Fit/Leads	5/8"+	1"+	Up to 1"	Up to 3/4"	1"+
S4473	3/4" Press Fit/Terminals	Up to 1/2"	1 1/4"+	Up to 1"	Up to 3/4"	1"+
S50R-12	1/4" Press Fit/Leads	Up to 1/2"	Up to 1 1/2"	1"+	3/4"+	Up to 1 1/4"
S50RF-12	1/4" Press Fit/Flanged/Leads	Up to 1/2"	Up to 1 1/2"	1"+	Up to 3/4"	Up to 1 1/4"
S50RS-12	1/4" Short Press Fit/Leads	Up to 3/8"	1"+	3/4"+	Up to 1/2"	Up to 1 1/4"
S5065	3/8" Press Fit/Leads	1/2"+	1"+	1"+	Up to 1"	Up to 1 1/4"

Magnet orientation will affect operation of switch. Please confirm operation prior to installation.

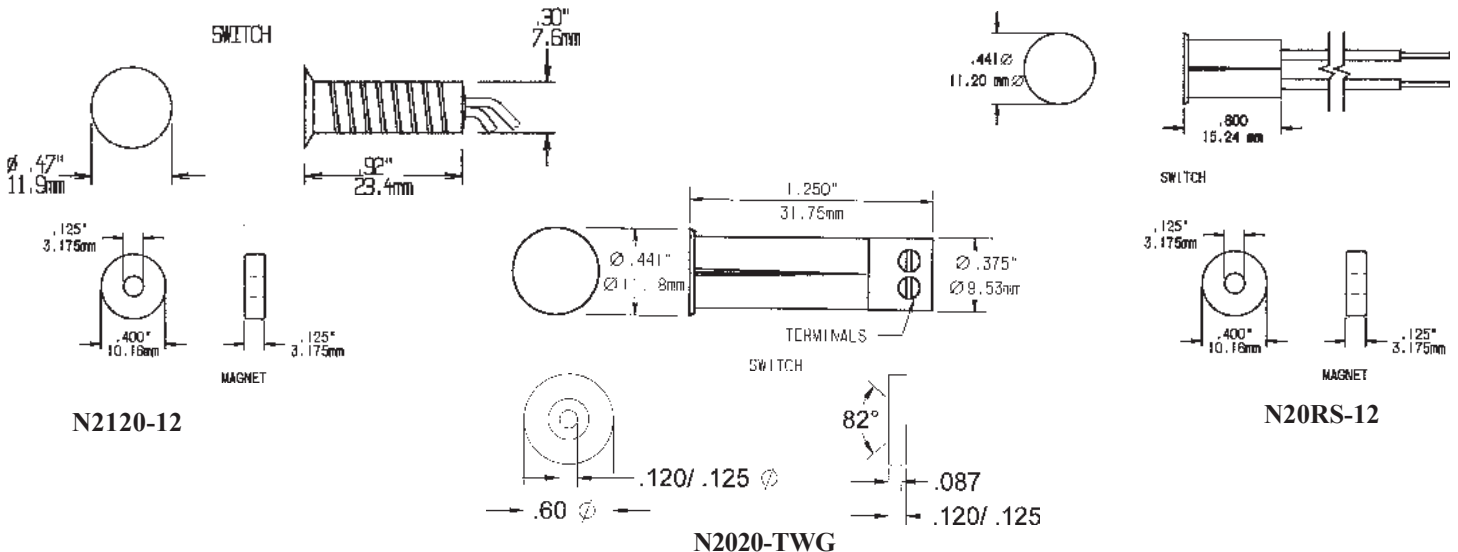

WARRANTY:

Lifetime warranty against workmanship, material and factory defects.

CONTACT YOUR G.R.I. DISTRIBUTOR OR CALL:

GEORGE RISK INDUSTRIES, INC.
GRI PLAZA
KIMBALL, NE 69145



MADE IN U.S.A.

TOLL-FREE 1-800-445-5218
TOLL-FREE 1-800-523-1227
(308) 235-4645
FAX (308) 235-3561
E-MAIL: grisales@megavision.com
WEB SITE: www.grisk.com