

XVR501H-8/16-4KL-X

8/16 Channel Penta-brid 4K Mini 1U Digital Video Recorder

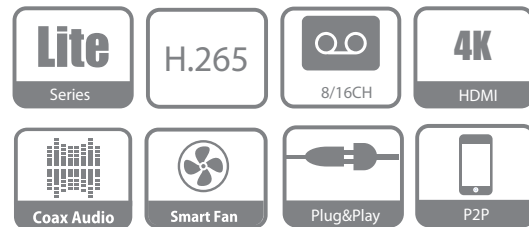

- H.265+/H.265 dual-stream video compression
- Supports HDCVI/AHD/TVI/CVBS/IP video inputs
- Max 12/24 channels IP camera inputs, each channel up to 8MP; Max 48/96Mbps Incoming Bandwidth
- Smart Search and Intelligent Video System



System Overview

With the surveillance operators pursuing to HD/UHD which further adds the storage and transmission cost, HDCVI H.265+/H.265 has been released to incredibly decrease the required bitrate while ensuring the video quality in realizing high resolution surveillance such as 4MP/4K.

The Lite Series is designed for high cost performance and quality. The range offers a great solution for users facing budget constraints who both require quality and performance. And with the adoption of Smart H.265+/H.265, the series improves encoding efficiency, saving on bandwidth/storage costs, and significantly reducing the Total Cost of Ownership (TCO).

Functions

Smart H.265+

Smart Codec, H.265+ can reduce up to 90% bit rate and storage requirements compared with H.264 without having to invest in new cameras.

HDCVI/AHD/TVI/CVBS Auto-detect

The XVR can auto recognize the signal of front-camera without any setting. It makes operation more friendly and convenient.

8MP Resolution

The XVR supports up to 8MP HD resolution (3840 x 2160) HDCVI camera and IP camera input.

Coaxial Audio/Upgrade/Alarm

The integrated design can reduce wiring troubles which makes it much more cost-effective and convenient for installation.

Long Distance Transmission

The HDCVI system supports long distance transmission over coaxial cable and UTP, max. 700m for 4K/4MP, 800m for 1080P and 1200m for 720P.

Smart Fan Design

The smart fan can automatically turn on or turn off according to the CPU temperature. This function can effectively reduce the fan noise to provide a better user experience.

Intelligent Video System (IVS)

With built-in intelligent video analytics, the XVR has the ability to detect and analyze moving objects for improved video surveillance. The XVR provides optional standard intelligence at the edge allowing detection of multiple object behaviors such as abandoned or missing objects. IVS also supports Tripwire analytics, allowing the camera to detect when a pre-determined line has been crossed.

Face Detection

It is a typical technology being used in a variety of applications for searching or identification of individuals.

Smart Search

This function helps you get more motion detect video during a short time through drawing a region when playback. It is very useful when an emergency occurs.

Technical Specification

System

| | |
|------------------|--------------------|
| Main Processor | Embedded Processor |
| Operating System | Embedded LINUX |

Video and Audio

| | |
|---------------------|---|
| Analog Camera Input | 8/16 Channel, BNC |
| HDCVI Camera | 4K, 6MP, 5MP, 4MP, 1080P@25/30fps, 720P@50/60fps, 720P@25/30fps |
| AHD Camera | 5MP, 4MP, 3MP, 1080P@25/30, 720P@25/30fps |
| TVI Camera | 5MP, 4MP, 3MP, 1080P@25/30, 720P@25/30fps |
| CVBS Camera | PAL/NTSC |
| IP Camera Input | 8+4/16+8 Channel, each channel up to 8MP |
| Audio In/Out | 1/1, RCA |
| Two-way Talk | Reuse audio in/Out, RCA |

Recording

| | |
|-------------------|--|
| Compression | H.265+/H.265/H.264+/H.264 |
| Resolution | 4K, 6MP, 5MP, 4MP, 3MP, 4M-N, 1080P, 720P, 960H, D1, CIF |
| Record Rate | Main stream: 4K(1~7fps); 6MP(1~10fps); 5MP(1~12fps); 4MP/3MP(1~15fps); 4M-N/1080P/720P/960H/D1/CIF(1~25/30fps) Sub stream:960H(1~15fps); D1/CIF(1~25/30fps) |
| Bit Rate | 32Kbps ~ 6144Kbps Per Channel |
| Record Mode | Manual, Schedule (General, Continuous), MD (Video detection: Motion Detection, Video Loss, Tampering), Alarm, Stop |
| Record Interval | 1 ~ 60 min (default: 60 min), Pre-record: 1 ~ 30 sec, Post-record: 10 ~ 300 sec |
| Audio Compression | AAC(only for the 1st channel), G.711A, G.711U, PCM |
| Audio Sample Rate | 8KHz, 16 bit Per Channel |
| Audio Bit Rate | 64Kbps Per Channel |

Display

| | |
|----------------------|---|
| Interface | 1 HDMI, 1 VGA |
| Resolution | HDMI:3840×2160, 2560×1440, 1920×1080, 1280×1024, 1280×720 VGA: 1920×1080, 1280×1024, 1280×720 |
| Multi-screen Display | When IP extension mode not enabled: 8CH: 1/4/8/9/16 16CH: 1/4/8/9/16 When IP extension mode enabled: 8CH: 1/4/8/9/16 16CH: 1/4/8/9/16/25 |
| OSD | Camera title, Time, Video loss, Camera lock, Motion detection, Recording |

Network

| | |
|------------------|---|
| Interface | 1 RJ-45 Port (1000M) |
| Network Function | HTTP, HTTPS, TCP/IP, IPv4/IPv6, Wi-Fi, 3G/4G, UPnP, RTSP, UDP, SMTP, NTP, DHCP, DNS, IP Filter, PPPoE, DDNS, FTP, Alarm Server, P2P, IP Search (Supports Dahua IP camera, DVR, NVS, etc.) |
| Max. User Access | 128 users |
| Smart Phone | iPhone, iPad, Android |
| Interoperability | ONVIF 16.12, CGI Conformant |

Video Detection and Alarm

| | |
|-----------------|--|
| Trigger Events | Recording, PTZ, Tour, Video Push, Email, FTP, Snapshot, Buzzer and Screen Tips |
| Video Detection | Motion Detection, MD Zones: 396 (22 × 18), Video Loss, Tampering and Diagnosis |
| Alarm input | N/A |
| Relay Output | N/A |

Playback and Backup

| | |
|-------------------|---|
| Playback | 8CH: 1/4/9 16CH: 1/4/9/16 |
| Search Mode | Time /Date, Alarm, MD and Exact Search (accurate to second) |
| Playback Function | Play, Pause, Stop, Rewind, Fast play, Slow Play, Next File, Previous File, Next Camera, Previous Camera, Full Screen, Repeat, Shuffle, Backup Selection, Digital Zoom |
| Backup Mode | USB Device/Network |

Storage

| | |
|--------------|----------------------------------|
| Internal HDD | 1 SATA Port, up to 10TB capacity |
| eSATA | N/A |

Auxiliary Interface

| | |
|-------|-------------------------------------|
| USB | 2 USB Ports (1 USB 2.0 , 1 USB 3.0) |
| RS232 | N/A |
| RS485 | 1 Port, for PTZ Control |

Electrical

| | |
|---------------------------------|-------------------------------|
| Power Supply | 8CH:DC12V/2A 16CH:DC12V/3A |
| Power Consumption (without HDD) | 8CH:<10W 16CH:<20W |

Construction

| | |
|------------------------------------|--|
| Dimensions | Mini 1U, 325mm×255mm×55mm (12.8" x 10" x 2.2") |
| Device with PFH101 Rack Mount Tray | 483mm×281mm×56mm (19.0"x11.1"x2.2") |
| Net Weight (without HDD) | 8CH: 1.2kg (4.2 lb) 16CH: 1.3kg (2.9 lb) |
| Gross Weight | 8CH: 1.9kg (4.2 lb) 16CH: 2.0kg (4.4 lb) |
| Installation | Desktop installation |

Environmental

| | |
|----------------------|--|
| Operating Conditions | -10°C ~ +55°C (+14°F ~ +131°F), 10% ~ 90% RH |
| Storage Conditions | -20°C ~ +70°C (-4°F ~ +158°F), 0% ~ 90% RH |

Third-party Support

| | |
|---------------------|---|
| Third-party Support | Dahua, Arecont Vision, AXIS, Bosch, Brickcom, Canon, CP Plus, Dynacolor, Honeywell, Panasonic, Pelco, Samsung, Sanyo, Sony, Videotec, Vivotek, and more |
|---------------------|---|

Certifications

| | |
|----------------|--|
| Certifications | FCC: Part 15 Subpart B |
| | CE: CE-LVD: EN 60950-1/IEC 60950-1 CE-EMC: EN 61000-3-2, EN 61000-3-3, EN 55032, EN 50130, EN 55024 |
| | UL: UL 60950-1 |

Ordering Information

| Type | Part Number | Description |
|---------------------|------------------|--|
| 8/16 Channel XVR | XVR501H-08-4KL-X | 8 Channel Penta-brid 4K 1U Digital Video Recorder |
| | XVR501H-16-4KL-X | 16 Channel Penta-brid 4K 1U Digital Video Recorder |
| Accessory, optional | PFH101 | Rack Mount Tray |

Dimensions (mm)

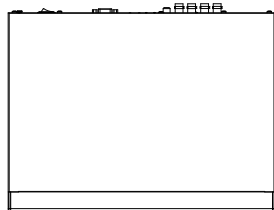
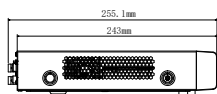
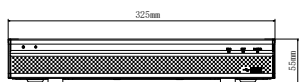

Installation on Rack Mount Tray

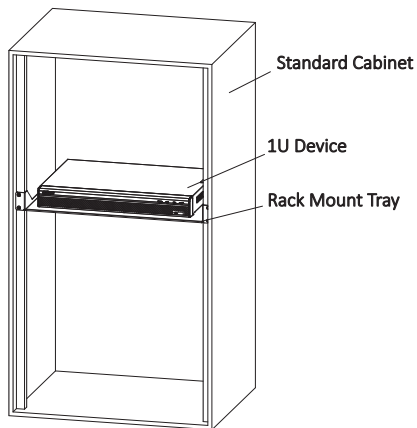

Rear Panel

XVR501H-08-4KL-X

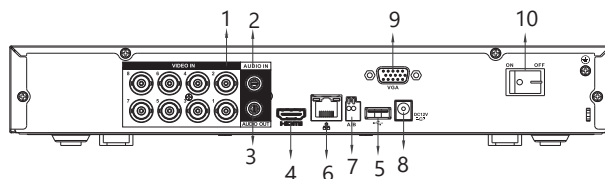

XVR501H-16-4KL-X

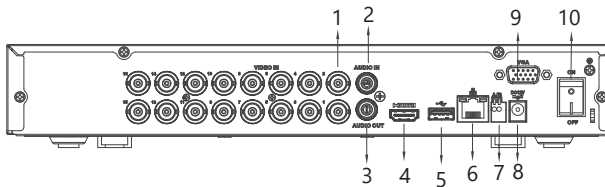

- | | | | |
|---|--------------------------|----|--------------------|
| 1 | VIDEO IN | 6 | Network Interface |
| 2 | AUDIO IN, RCA Connector | 7 | RS485 Interface |
| 3 | AUDIO OUT, RCA Connector | 8 | DC 12V Power Input |
| 4 | HDMI Interface | 9 | VGA Interface |
| 5 | USB Interface | 10 | Power Switch |