

PFC-6006 Sprinkler Monitoring Panel

Installation, Operation & Programming Manual



Potter Electric Signal Company, LLC

St. Louis, MO

Customer Service: (866) 240-1870 • Technical Support: (866) 956-1211 • Fax: (314) 595-6999

www.pottersignal.com

Manual #5403559–Rev E

4/19



WARRANTY INFORMATION

The essential purpose of any sale or contract for sale of any of the products listed in the POTTER catalog or price list is the furnishing of that product. It is expressly understood that in furnishing said product, POTTER does not agree to insure the Purchaser against any losses the Purchaser may incur, even if resulting from the malfunction of said product.

POTTER warrants that the equipment herein shall conform to said descriptions as to all affirmation of fact and shall be free from defects of manufacture, labeling and packaging for a period of one (1) or five (5) year(s), depending on the product, from the invoice date to the original purchaser, provided that representative samples are returned to POTTER for inspection. The product warranty period is stated on the exterior of the product package. Upon a determination by POTTER that a product is not as warranted, POTTER shall, at its exclusive option, replace or repair said defective product or parts thereof at its own expense except that Purchaser shall pay all shipping, insurance and similar charges incurred in connection with the replacement of the defective product or parts thereof. This Warranty is void in the case of abuse, misuse, abnormal usage, faulty installation or repair by unauthorized persons, or if for any other reason POTTER determines that said product is not operating properly as a result of causes other than defective manufacture, labeling or packaging.

The Aforesaid Warranty Is Expressly Made In Lieu Of Any Other Warranties, Expressed Or Implied, It Being Understood That All Such Other Warranties, Expressed Or Implied, Including The Warranties Of Merchantability And Fitness For Particular Purpose Are Hereby Expressly Excluded. In No Event Shall Potter Be Liable To Purchaser For Any Direct, Collateral, Incidental Or Consequential Damages In Connection With Purchaser's Use Of Any Of The Products Listed Herein, Or For Any Other Cause Whatsoever Relating To The Said Products. Neither Potter Nor Its Representatives Shall Be Liable To The Purchaser Or Anyone Else For Any Liability, Claim, Loss, Damage Or Expense Of Any Kind, Or Direct Collateral, Incidental Or Consequential Damages Relative To Or Arising From Or Caused Directly Or Indirectly By Said Products Or The Use Thereof Or Any Deficiency, Defect Or Inadequacy Of The Said Products. It Is Expressly Agreed That Purchaser's Exclusive Remedy For Any Cause Of Action Relating To The Purchase And/or Use Of Any Of The Products Listed Herein From Potter Shall Be For Damages, And Potter's Liability For Any And All Losses Or Damages Resulting From Any Cause Whatsoever, Including Negligence, Or Other Fault, Shall In No Event Exceed The Purchase Price Of The Product In Respect To Which The Claim Is Made, Or At The Election Of Potter, The Restoration Or Replacement Or Repair Of Such Product.

Potter Electric Signal Company, LLC

5757 Phantom Drive Ste 125 • St. Louis, MO 63042 • 314-595-6900 • 800-325-3936

Table of Contents

Section 1: Introduction	1-1
Purpose of This Manual	1-1
System Overview	1-1
System Features	1-1
<i>P-Link Accessories</i>	1-1
How to Use this Manual	1-1
Common Terminology	1-1
Section 2: Before You Start Installation	2-2
System Specifications	2-2
Environmental Specifications	2-2
Model / Available Cabinet Colors	2-2
System Configurations / Appliances	2-2
Electrical Specifications	2-3
System Size Specifications	2-3
Main Board Wiring Specifications	2-3
<i>Circuit Separation</i>	2-3
<i>Wiring Types</i>	2-4
Cabinet Dimensions	2-5
Cabinet Mounting Instructions	2-6
Cabinet Wiring Connections	2-7
Battery Circuit Calculations	2-8
Main Supply Circuit	2-9
Battery Connections	2-9
Section 3: Installation	3-10
Input Circuits	3-10
<i>Input Wiring Specifications</i>	3-10
<i>Input Circuit #1 Class A, Style D Wiring Configuration</i>	3-10
<i>Input Circuits #1-6 Class B, Style B Wiring Configuration</i>	3-11
Notification Appliance Circuits Installation	3-12
<i>NAC Wiring Characteristics</i>	3-12
<i>NAC Maximum Wiring Impedance Formula</i>	3-12
<i>NAC Wiring Configuration</i>	3-12
P-Link Points	3-13
<i>Configuration Characteristics</i>	3-13
<i>Maximum Wire Resistance Formula (Wire Length)</i>	3-13
<i>P-Link Addresses</i>	3-14
Remote Annunciator Installation (RA-6075)	3-14
<i>Setting Addresses</i>	3-14
DACT Connection	3-15
Auxiliary Power	3-15
Section 4: Operation	4-16
Control Panel Basic Operation	4-16
<i>LCD Display</i>	4-16
<i>Menu Navigation Keys</i>	4-17
<i>Numeric Keypad</i>	4-17
<i>Function Pushbuttons</i>	4-17
<i>Status LEDs</i>	4-18

Control Panel Menu Tree	4-20
Section 5: Programming	5-21
Programming Options	5-21
Programming Overview	5-23
The Programming Cycle	5-23
Software Installation	5-23
LEARN Programming	5-24
Connecting the Computer and Panel.....	5-24
Transferring Data	5-26
<i>Uploading from Panel to Computer</i>	5-27
Downloading Configuration File to Panel	5-28
<i>Enable Remote Access</i>	5-28
<i>File New</i>	5-29
<i>File Save / Save As</i>	5-29
<i>Audit Errors</i>	5-29
Uploading History Events Status Reports.....	5-31
<i>History Reports</i>	5-31
<i>Printing Reports</i>	5-32
Panel Software Overview	5-33
<i>Window Regions / Areas</i>	5-33
<i>Program Icons</i>	5-34
Programming Functions Overview	5-35
Remote Access Code.....	5-36
<i>User Name / Password</i>	5-36
General System Functions	5-37
<i>Job Details</i>	5-37
<i>General Options</i>	5-37
<i>Users</i>	5-38
System E-mail Functions	5-39
<i>P-Link E-mail Notification Requirements</i>	5-40
<i>Connecting the Panel to a Network</i>	5-40
<i>E-mail Sent from Panel</i>	5-41
<i>E-mail Report Requested from PC</i>	5-42
<i>Receiving E-mail Status Reports</i>	5-44
<i>Creating E-mail Reminders</i>	5-45
System Programming.....	5-46
<i>Mapping Zones Overview</i>	5-46
<i>Single Zones</i>	5-46
<i>Multiple Zones</i>	5-46
<i>Mapping Terminology</i>	5-47
<i>Zone Types / Styles</i>	5-47
<i>Zone Attributes</i>	5-48
<i>Creating Zones</i>	5-49
<i>Configuring Zones</i>	5-50
<i>Configuring Points</i>	5-50
<i>Input Circuit Functions</i>	5-51
<i>NAC Functions</i>	5-52

<i>AUX Functions</i>	5-52
<i>Adding Points to Zones</i>	5-54
<i>Group by Area</i>	5-56
Programming Points & Appliances.....	5-58
<i>On-Board DACT</i>	5-58
<i>Remote Annunciators</i>	5-59
Section 6: IP Communication	6-60
<i>IP Reporting Accounts</i>	6-61
Section 7: Appendices	7-63
Appendix A – Basic Operating Instructions.....	7-63
Appendix B – Modem Connectivity Setup.....	7-65
Appendix C – System Maintenance and Testing	7-66
<i>Acceptance Test</i>	7-66
<i>Periodic Testing and Service</i>	7-66
<i>Operational Checks</i>	7-66
<i>AC Fuse</i>	7-66
<i>Battery Fuse</i>	7-66
<i>Battery Maintenance</i>	7-66
<i>Replacement and Testing Recommendations</i>	7-67
<i>Proper Handling / First Aid Procedures</i>	7-67
Appendix D – Compatible Points Table	7-68
Appendix E – Compatible Smoke Detectors Table	7-69
Appendix F – Compatible Auxiliary Circuit Devices.....	7-71
Appendix G – Control Panel Menu	7-72

PFC-6006 Sprinkler Monitoring Panel

Installation, Operation & Programming Manual

Section 1: Introduction

The PFC-6006 Sprinkler Monitoring Panel is a compact, simple panel designed to monitor all facets of a wet or dry fire sprinkler system and communicate the status to a monitoring station. The PFC-6006 panel is a listed and approved microprocessor based sprinkler monitoring panel and complies with UL-864, NFPA-70, and NFPA-72, and NYC Fire Department Certificate of Approval #6159 & 6184. The panel is provided with six (6) inputs and one 24VDC, 0.5 Amp Notification Appliance Circuit (NAC) with strobe synchronization. The 2.0 Amp power supply provides ample power to meet any jurisdictions requirements and will house and charge up to two (2) 18 amp/hour batteries. In addition, the panel has the Potter P-Link for connection to remote annunciators. The panel has a total 0.5 Amp auxiliary power output for controlling ancillary fire alarm functions.

Purpose of This Manual

This manual is intended to assist in the installation and programming the PFC-6006 Sprinkler Monitoring Panel. Refer to this manual to properly install and program the PFC-6006. It is recommended that the user follows the procedures as outlined in this manual to assist in proper installation and prevent damage to the control panel and associated equipment.

System Overview

The PFC-6006 system is designed for use as a sprinkler fire control panel for life safety applications.

System Features

- The PFC-6006 has six (6) programmable input circuits.
- 2.0 Amp (24vdc) Power Supply
- One (1) Notification Appliance Circuit (NAC) rated at 0.5A maximum.
 - Power Limited
 - Built in Sync
 - Cadence and Temporal Patterns
 - Programmable as Supervisory
- One (1) programmable auxiliary output rated at 0.5 A.
- Support for all major synchronization patterns.
 - Potter/AMSECO®
 - Gentex®
 - CooperWheelock®
 - System Sensor®
- Auto Silence and Silence Inhibit.
- Built-in Ethernet port for programming and network connectivity.
- P-Link RS-485 bus supports system accessories.
- Dead-front Cabinet Design

P-Link Accessories

- RA-6075 Remote Annunciator – Maximum of 4 per system

How to Use this Manual

Refer to this manual before contacting Technical Support. The information in this manual is the key to a successful installation and will assist you in understanding proper wire routing, system requirements, and other guidelines specific to the PFC-6006 system.

Common Terminology

The following table provides you with a list of terms and definitions used with the PFC-6006 system:

Table 1: Terminology	
Term	Definition
PFC-6006 Cabinet	Enclosure
EOLR	End of Line Resistor Assembly
Remote Annunicator	LCD type Remote Annunicator
NAC	Notification Appliance Circuit
P-Link	Proprietary RS-485 communication bus
PFC-6006 PCB	Board Assembly for complete unit

Section 2: Before You Start Installation

This section addresses information that will help you in completing a successful installation, such as the PFC-6006 cabinet layout, specifications, and environmental considerations.

System Specifications

Cabinet Description

- Eighteen (18) gauge sheet steel with hinged, removable locked door
- Enclosure dimensions – 18-1/2" x 14-1/4" x 4-3/4"

Visual Indicators

- LCD (2 x 16 alphanumeric character display)
- LED indicators (Red, Green, Amber)

LCD Description

- Alarm, Supervisory and Trouble conditions display applicable condition, status and circuit for each correlating condition

Environmental Specifications

- Mount indoors only.
- Temperature 32° to 120°F, humidity 93% non-condensing.
- Verify panel is properly grounded.
- Remove all electronic assemblies prior to any drilling, filing, reaming, or punching of the enclosure. When possible, make all cable entries from the sides, bottom, or rear of the cabinet. Verify that they will not interfere with the batteries or other components.
- The panel and system must be tested and maintained in accordance with all local and national codes and ordinances.
- Panel shall be installed so the display is easily readable and the door shall have adequate clearance to access the controls.

Model / Available Cabinet Colors

- 3992334 – RED PFC-6006 Sprinkler Monitoring Panel
- 3992336 – BLACK PFC-6006 Sprinkler Monitoring Panel

System Configurations / Appliances

Table 2: System Configurations / Appliances					
Model	Description	Local	Remote Station	Central Station	Proprietary
PFC-6006	Main Board/Panel Assembly	Y	Y	Y	Y
RA-6075	LCD remote annunciator (NFPA)	O	O	O	O
3005013	End of line resistor assembly	Y	Y	Y	Y
Y = Yes, required for applicable section N = No, not required for applicable section O = Optional, may or may not be used, has no affect on the applicable section.					

Electrical Specifications

Please refer to the table below for electrical specifications:

Table 3: System Panel Electrical Specifications				
Panel	# NAC	Rating per NAC	Notes	Style and Class
PFC-6006	1 NAC	0.5 Amp	Input Circuit 1 may be configured as Class A or Class B; Inputs 2-6 as Class B only.	Inputs – Class A or B NAC – Class B P-Link – Class B All are Low Voltage and Power Limited

System Size Specifications

Please refer to the table below for system size specifications:

Table 4: System Size Specifications	
Accessories/Subassemblies	Maximum System Size
PFC-6006	<ul style="list-style-type: none"> • Six (6) input circuits on the main board • One (1) notification circuit on the main board • One (1) on-board DACT • One (1) auxiliary power output* • One (1) P-Link connection*
*Note: P-Link 24VDC and auxiliary power combined are not to exceed 0.5A.	

Main Board Wiring Specifications

There are several wiring requirements to consider **before** connecting circuits to the main board: (1) the circuit separation, and (2) wiring types.

All wiring should be sized and installed to comply with NFPA 70, NFPA 72, and local codes and ordinances.

Circuit Separation

Proper separation between the different types of circuits must be maintained between Power Limited, Non-Power Limited, and High Voltage wiring to reduce electrical interferences, transient voltage or voltage ratings.

- Separations between the different wiring types **must** be maintained by at least ¼ inch and the wire insulation **must** be for the higher voltage.
- The control panel cabinet has sufficient knockouts located around the periphery allowing the installer to maintain separation between power limited and non-power limited connections.

Wiring Types

Wiring specifications must be followed to prevent damage or other consequences. Please refer to the wiring diagram below for proper wiring requirements.

Figure 1. PFC-6006 Wire Routing Example

Wire Routing for PFC-6006

(*Shown with false front removed)

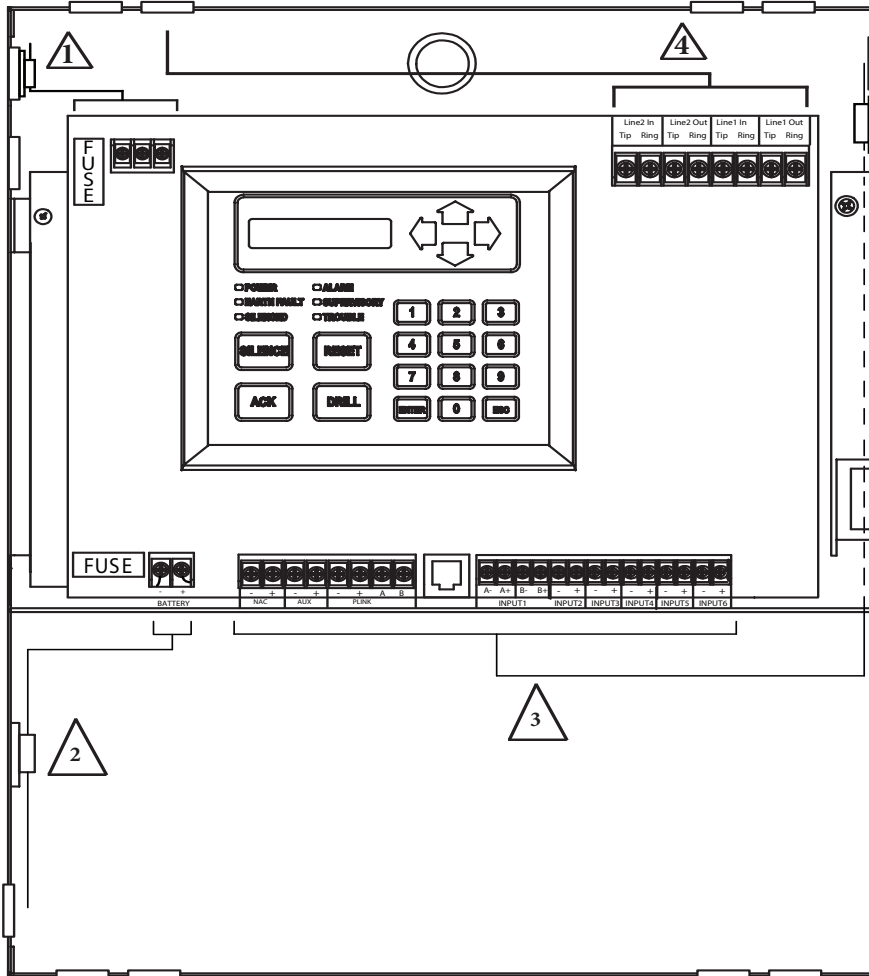

DWG #559-12

- 1** Power Inputs
- 2** Battery leads
- 3** Route all other wiring away from power input wiring.
- 4** Run DACT phone lines separately.

NOTICE

All field installed wiring connected to this panel must maintain a spacing of 1/4" between all electric light, power, class 1 or non-power limited fire protective signaling conductors.

Refer to table below for a breakout of the different wiring requirements shown by circuit type:

Table 5: Main Board Circuit Wiring Types		
Type of Circuit	Wiring Type	
	Voltage	Power
AC Connection	High Voltage	Non-Power Limited
Battery Connection	Low Voltage	Non-Power Limited
Input Circuits	Low Voltage	Power Limited
Notification Device Circuit (NAC)	Low Voltage	Power Limited
P-Link RS-485 Connections	Low Voltage	Power Limited
Phone Line – DACT	High Voltage	Non-Power Limited
AUX Power	Low Voltage	Power Limited

Cabinet Dimensions

Figure 2. PFC-6006 Main Board Module Shown Installed in Cabinet (shown with door removed)

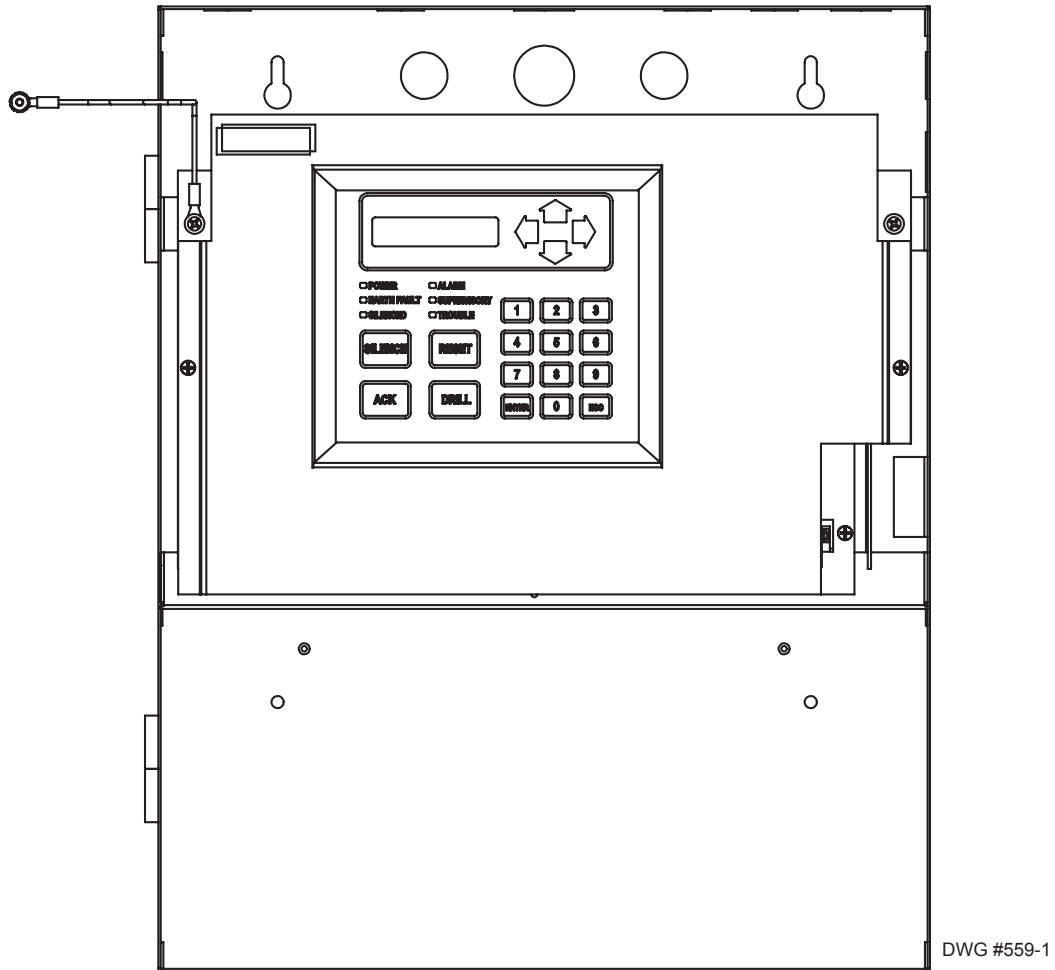
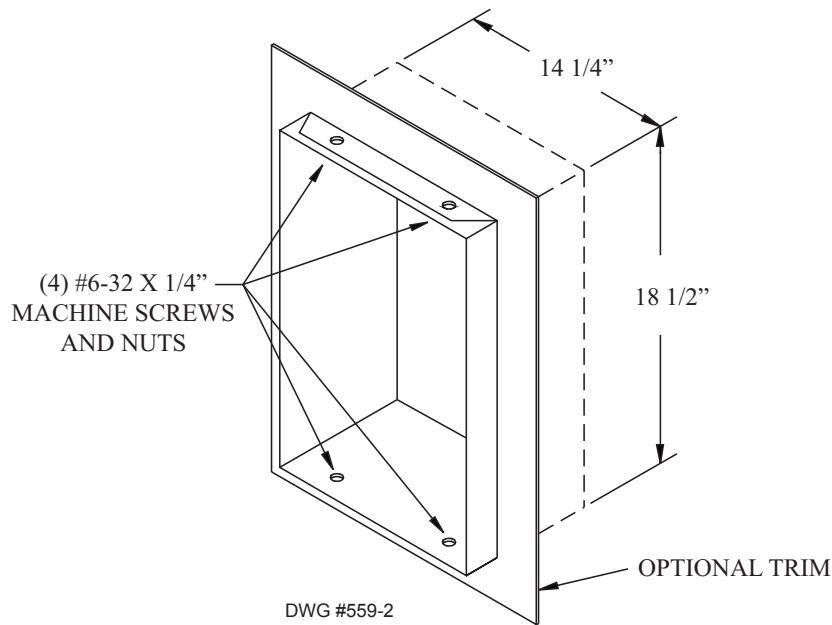

Figure 3. PFC-6006 Panel Showing Bezel Dimensions



Cabinet Mounting Instructions

To mount the cabinet:

1. The unit should be mounted in a convenient location, approximately 5 feet from the floor where it will be accessible for testing and servicing.
2. The main circuit board module should be removed before attempting to mount the cabinet. Disconnect the AC power from TB5. To remove the module, remove the two screws holding the chassis to the cabinet. Lift the module upwards, approximately 1/2", in order to clear the cross-beam of the cabinet on which the module rests. Remove the module and set aside.
3. The PFC unit may be surface mounted or semi-flush mounted using the optional trim bezel (*refer to drawings shown earlier in this section*). For semi-flush installations mount the housing so that the front edge protrudes 1" from the finished wall surface. After all conduits and wiring are in place and the wall surface is completely finished, slide the trim bezel in place and fasten with 4 #6-32 x 1/4" machine screws and nuts.
4. Install all required conduits, external wiring and points and make all connections that are external to the panel. Replace the module. With the AC power still turned off at the circuit breaker panel, connect the AC hot, neutral and ground wires to the terminal block TB5 as shown in the "*Cabinet Wiring Connections*" drawing shown in this section.
5. Connect all the other wiring to the terminals as shown in the connection drawings. Turn the AC power on and connect the standby batteries with the cable provided, polarity must be observed.
6. Replace false front panel and secure with mounting screws, taking care to not damage LED annunciator module cable.
7. Verify the operation of the complete system as outlined in the test procedure section.

Cabinet Wiring Connections

Figure 4. PFC-6006 Cabinet Wiring

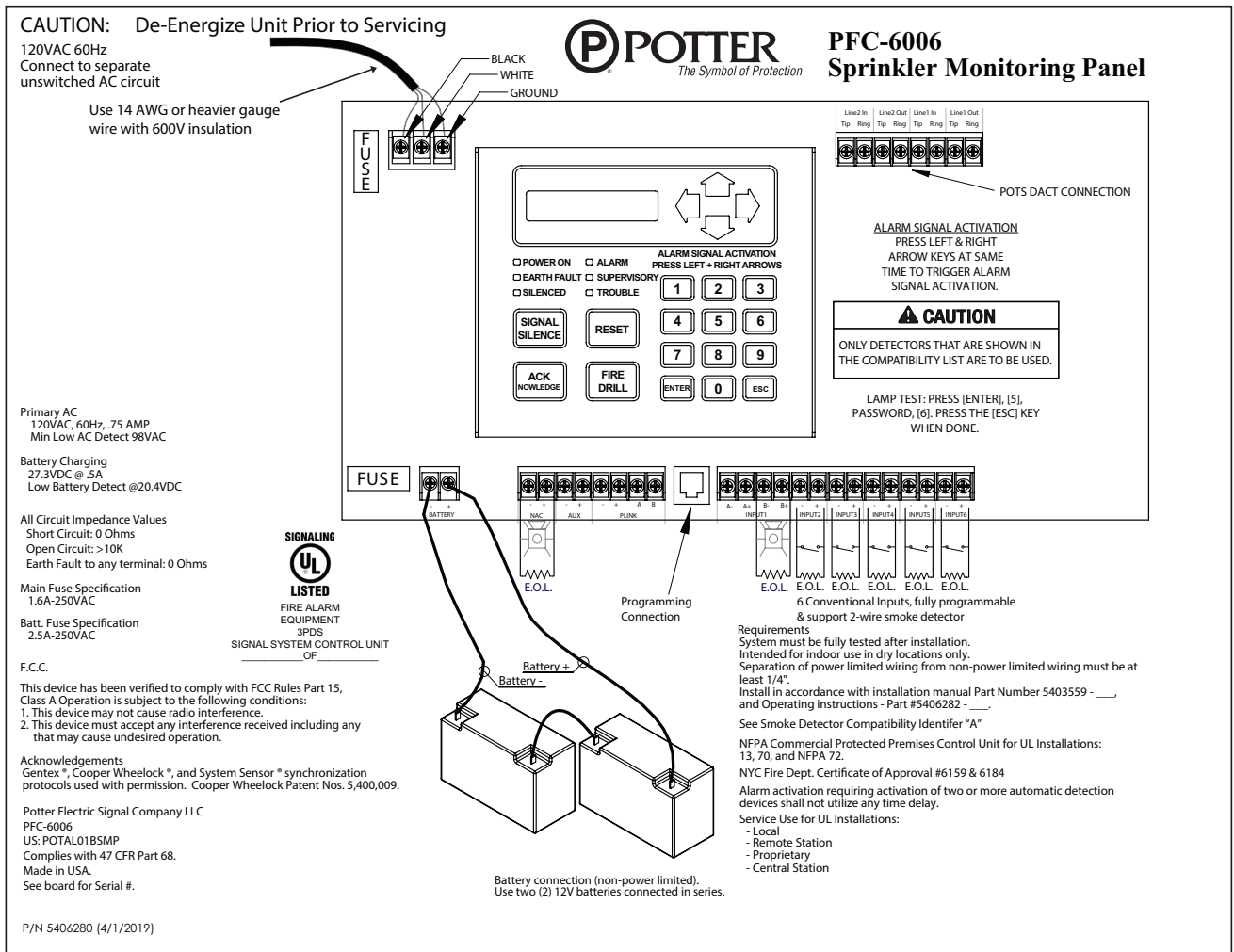

Battery Circuit Calculations

Before selecting the battery, it is important to determine the minimum size batteries for standby and alarm times desired for each application. If the wrong batteries are installed in a specific application or incorrect current draw used, the proper standby and minimum alarm time will not be present.

The battery circuit is rated for 8 to 18 AH batteries and will operate the panel alarm for at least 24 hours and 5 minutes. The cabinet will house up to two (2) 8 AH or two (2) 18 AH batteries.

Please use the worksheet shown below to calculate the battery size and current draw required for each application:

Battery Calculation Worksheet

Description	Quantity	Standby (mA)	Total Standby (mA)	Alarm (mA)	Total Alarm (mA)
Main board (PFC-6006)	1	105		160	
LCD Remote RA-6075		20		25	
Input Circuit #1					
Input Circuit #2					
Input Circuit #3					
Input Circuit #4					
Input Circuit #5					
Input Circuit #6					
NAC 1					
		Total (ma)		Total (ma)	
		Convert to Amps	x 0.001	Convert to Amps	x 0.001
(*Refer to maximum allowable standby current) Total A:				Total A:	
		Multiply by standby hours	x _____	<u>60 minutes per hour</u> Alarm time (minutes) <i>Example:</i> 5 minute alarm: enter 12	÷ _____
Total Standby AH				Total Alarm AH	
				+Total Standby AH	
				Total AH	
				Efficiency Factor	÷ 0.80
				Required AH	

<p>*Maximum Allowable Standby Current (UL 24-Hour standby time)</p> <p>8 AH .265 A</p> <p>18 AH .597 A</p>	<p>Important Notes:</p> <ol style="list-style-type: none"> 1) FACP enclosure can house up to two (2) 18 AH batteries. 2) NFPA 72 requires 24 hours of standby power followed by 5 minutes of alarm activation. 3) Door holder circuits configured to disconnect upon AC loss need not be included in the battery standby calculation since they will not draw power during that time. Door holders will contribute to standby current draw when AC is present. 4) Total current must not exceed power supply rating (2A on PFC-6006). 5) LED/Relay current must be accounted for in the battery calculation for the supplying source.
---	---

Main Supply Circuit

The AC terminals are located in the upper left hand portion of the main board. The main board supervises the main AC power and provides indication that the AC power is absent. The terminals are rated at 120 VAC 60 Hertz and are marked so accordingly on the board.

Figure 5. PFC-6006 AC Terminals

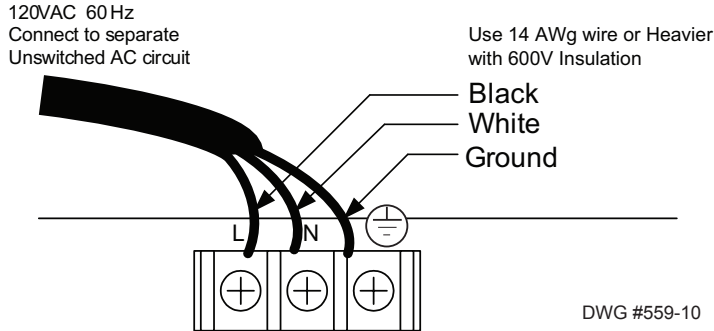

The earth ground connection is marked as “” and is the furthest connection from the line voltage connection.

The AC input power rating is: Maximum of .75A at the nominal 120 VAC rating.

Battery Connections

The battery charging circuit is located on the main panel in the lower left portion of the board. The maximum battery charging current is .5 amp DC; the charging voltage is approximately 27.3 VDC and is supervised.

Note: The battery should be clearly labeled as “*Sealed Lead Acid Battery*” or equivalent UL listed or UL Recognized.

Connect the battery wire leads to the terminal connections, as shown. Batteries should be replaced every five (5) years or sooner depending on annual testing.

Figure 6. PFC-6006 Battery Connections

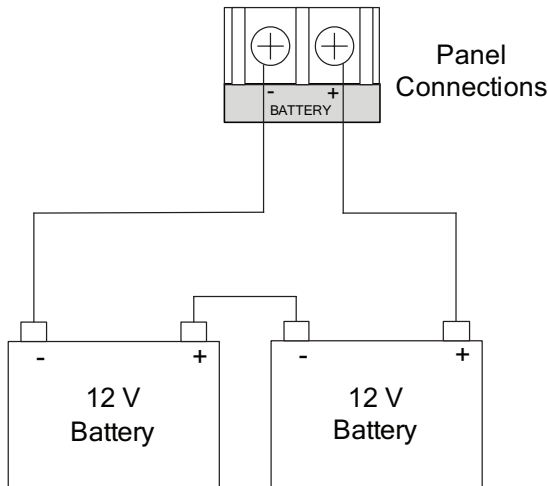

Section 3: Installation

This section addresses installation procedures for Input Circuits 1–6, the NAC, the on-board DACT, and the optional RA-6075 Remote Annunciator. Wiring requirements and configuration examples are included throughout this section. Please read this section carefully before installing points and accessories to ensure proper installation.

Input Circuits

There are six (6) programmable Input or Initiating Device Circuits (IDC) provided on the PFC-6006, which are the same as a conventional fire system input. They are supervised, and power limited to protect 2-wire smoke detectors. Input Circuit #1 may be wired for either Class A, Style D or Class B, Style B; whereas Inputs #2-6 may be Class B, Style B only. All inputs are suitable for automatic, manual, waterflow or sprinkler supervisory service. *(Please refer to the wiring examples located in this section.)*

Note: The panel has the intelligence to determine the applicable style for Input Circuit #1 based on the wiring configuration used.

Input Wiring Specifications

- Maximum short circuit current = 32mA.
- Maximum wiring resistance = 100 Ohms.
- Maximum wiring capacitance = 1 mF.
- Maximum wire length in feet = 100/Ohms per 1 ft. of wire.
- Normal standby current = 2.5 mA.
- Operating voltage range = 15.1VDC - 25.4VDC.

Input Circuit #1 Class A, Style D Wiring Configuration

Figure 7. Example of Input 1, Class A, Style D

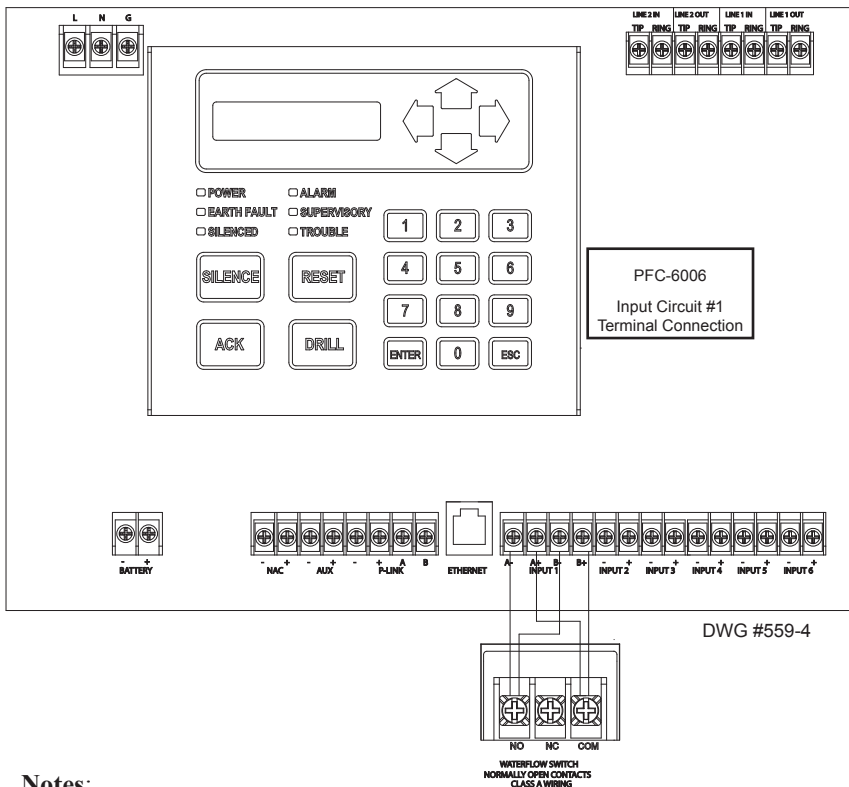

Notes:

1. Input Circuit #1 may be wired as either Class A or Class B.
2. All other inputs are Class B only.
3. Maximum wiring resistance must not exceed 100 ohms.
4. The input has ground fault detection with 0 ohm impedance to ground.
5. The Potter part number for the listed end of line assembly is #3005013 EOL Resistor Assembly.

Input Circuits #1-6 Class B, Style B Wiring Configuration

Figure 8. Example of Inputs Wired as Class B, Style B

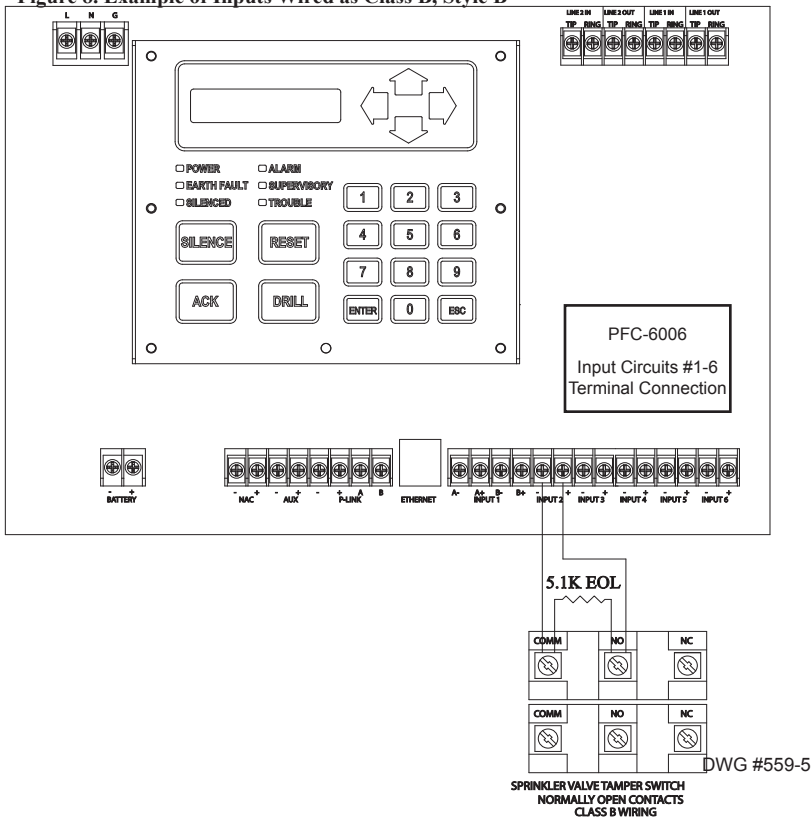

Notes:

1. Maximum wiring resistance must not exceed 100 ohms.
2. The input has ground fault detection with 0 ohm impedance to ground.
3. The Potter part number for the listed end of line assembly is #3005013 EOL Resistor Assembly.

Notification Appliance Circuits Installation

There is one (1) NAC circuit provided on the PFC-6006 rated as continuous 0.5 amps at 24 VDC. The NAC circuit is configurable as Class B, Style Y only. *(Please refer to the wiring example located in this section.)*

NAC Wiring Characteristics

- Output is supervised and regulated.
- Circuit is power limited.
- Normal standby supervisory current is approximately 1.2 mA
- Low current trouble activation is 0.8 mA; High current trouble activation is 1.7 mA.
- Maximum RMS current is .5A.

Note: Type of NAC output is selectable, and may be configured for strobe synchronization with Potter/AMSECO®, Cooper Wheelock®, Gentex®, or System Sensor® strobe points. Refer to the listing of compatible models located in the “*NAC Compatibility Document*”, Potter #5403592, for this information.

NAC Maximum Wiring Impedance Formula

The maximum impedance is a *function* of the *load* placed on the circuit. To calculate the maximum line current impedance, use the following formula:

$$(\text{Alarm Current of Notification Appliance}) \times (\text{Wire Resistance}) < 1.2 \text{ Volts}$$

NAC Wiring Configuration

Figure 9. NAC Class B, Style Y Wiring Example

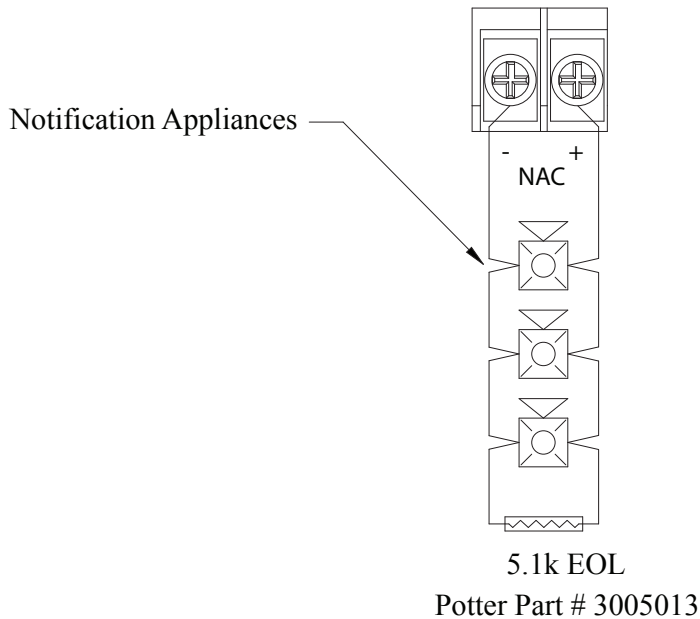

Note: the resistance of external wiring shall be determined using the following formula ---
 $(\text{Alarm Current of Notification Appliance}) \times (\text{Wire Resistance}) < 1.2 \text{ Volts}$

DWG #559-6A

Notes:

1. The Potter part number for the listed end of line assembly is #3005013 EOL Resistor Assembly.
2. The panel has ground fault detection on the NAC circuit. The impedance to ground for ground fault detection is 0 ohms.
3. The 1.2 Volts is based on the worst case loading at the remote end of the NAC circuit (lump sum method). The total drop of 1.2 Volts should be measured from the terminals to the most remote device.

P-Link Points

Accessory points, such as the RA-6075 remote annunciator, are connected to the main control panel utilizing the four-wire P-Link bus for power and communication. This panel supports a maximum of four (4) P-Link points, which can be connected using a Class B, Style 4 wiring style.

Configuration Characteristics

- P-Link current rating may not exceed 0.5 amp based on the total between auxiliary and P-Link.
- P-Link maximum current is 500 mA.
- P-Link voltage rating is 24 VDC.
- Continuous DC frequency.
- P-Link circuit is supervised and power-limited.

Maximum Wire Resistance Formula (Wire Length)

The maximum resistance is based on the *load* placed on the circuit. To calculate the maximum wire resistance, use the following formula:

$$(\text{Total Annunciator Alarm Current}) \times (\text{Wire Resistance}) < 6 \text{ Volts}$$

Figure 10. P-Link Device Class B Wiring Example

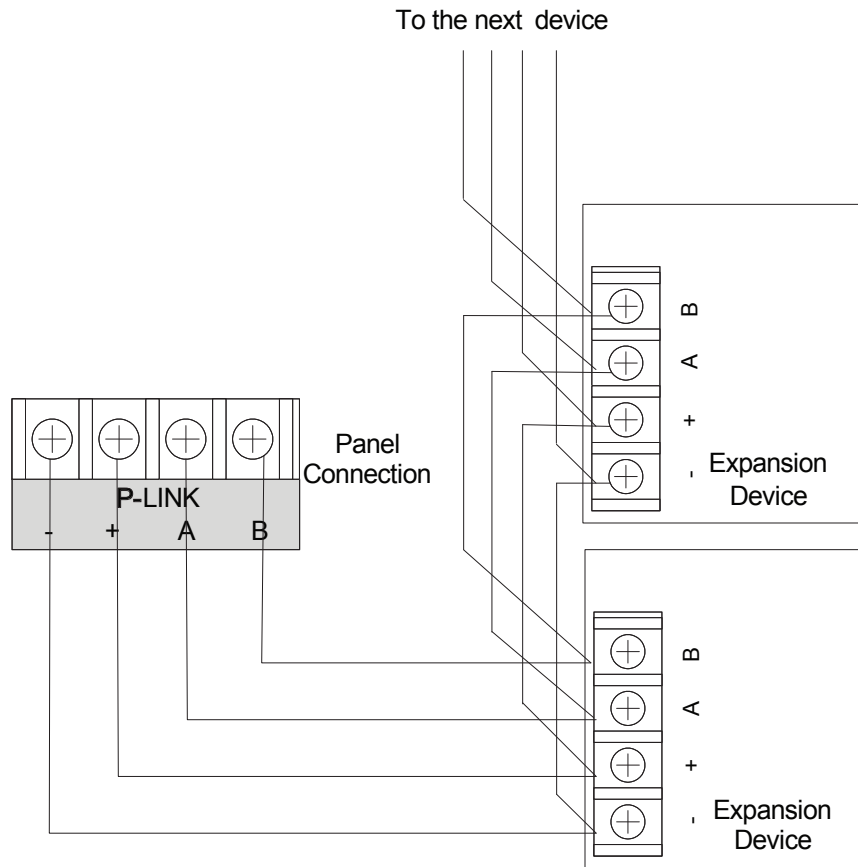

DWG #602-11A

P-Link Addresses

Every P-Link device has a five position dip switch which is used to program the device address ranging from one (1) to thirty-one (31). Use the chart below to reference Dip Switch Settings:

Annunciator Address	Dip Switch Settings				
	SW-1	SW-2	SW-3	SW-4	SW-5
1	On	Off	Off	Off	Off
2	Off	On	Off	Off	Off
3	On	On	Off	Off	Off
4	Off	Off	On	Off	Off
5	On	Off	On	Off	Off
6	Off	On	On	Off	Off
7	On	On	On	Off	Off
8	Off	Off	Off	On	Off
9	On	Off	Off	On	Off
10	Off	On	Off	On	Off
11	On	On	Off	On	Off
12	Off	Off	On	On	Off
13	On	Off	On	On	Off
14	Off	On	On	On	Off
15	On	On	On	On	Off
16	Off	Off	Off	Off	On

Annunciator Address	Dip Switch Settings				
	SW-1	SW-2	SW-3	SW-4	SW-5
17	On	Off	Off	Off	On
18	Off	On	Off	Off	On
19	On	On	Off	Off	On
20	Off	Off	On	Off	On
21	On	Off	On	Off	On
22	Off	On	On	Off	On
23	On	On	On	Off	On
24	Off	Off	Off	On	On
25	On	Off	Off	On	On
26	Off	On	Off	On	On
27	On	On	Off	On	On
28	Off	Off	On	On	On
29	On	Off	On	On	On
30	Off	On	On	On	On
31	On	On	On	On	On

Remote Annunciator Installation (RA-6075)

Up to four (4) annunciators may be connected to the main sprinkler monitoring panel. The RA-6075 provides a 2 x 16 character LCD display, along with standard function and numeric keys. It is listed and designed be mounted on a flat non-condensing surface or electrical box.

Setting Addresses

An annunciator's address is set by dip switch S1, which is located on the back of the annunciator. The address must be set in the range of one to thirty-one (1–31) to be recognized by the panel. (Refer to chart shown above for P-Link DIP switch programming.)

Figure 11. Annunciator Back Panel View

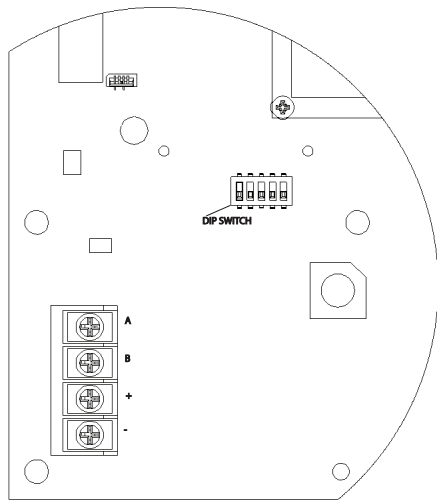

DWG #593-31

DACT Connection

NOTICE

Phone lines are high voltage and should be run in a separate conduit from other circuits. The wire conductors connecting the DACT to the phone system should be 26 AWG or larger.

The Digital Alarm Communicator Transmitter (DACT) provides connections for two (2) phone lines for communication to a monitoring station. The DACT communicates using the SIA-DCS or Ademco Contact ID protocols. The DACT is selectable and fully programmable.

The PFC-6006 automatically monitors each phone line for voltage and has the ability to seize the line and connect with a remote receiver. Once the communication is complete, the DACT will hang up the phone line.

The DACT is provided with terminals block for each phone line (see Figure 12). In order for the DACT to work properly, it must be installed on a plain old telephone service (POTS) or equivalent as deemed by the authority having jurisdiction. The DACT must be installed before any other equipment to ensure it can seize the line and disconnect any other lines.

When the phone lines are connected to the control panel, the phone lines are supervised. The phone lines are non-power limited and should be routed accordingly.

In order for the system to comply with building and fire codes, the DACT is to be connected between the telephone company connection and other appliances serving the building. Failure of the DACT to be the first device on the line will prevent it from seizing the phone line and acquiring dial tone.

Figure 12. DACT Connections

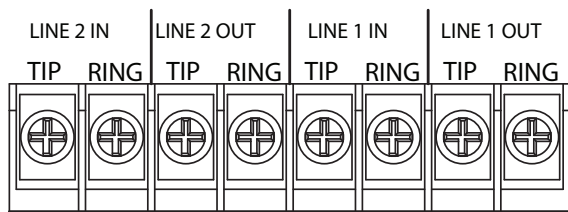

DWG #559-16

Auxiliary Power

The Auxiliary Power is a 24 VDC output rated at a maximum of 0.5 Amps that is shared with the P-Link power. The total combined power between the two auxiliary power connections is 0.5 Amps. The auxiliary power may be programmed as continuous or resettable with a System Reset for use with 4-wire smoke detectors.

Aux Power Characteristics

- The impedance to ground for ground fault detection is 0 ohms.
- Supervised and power-limited.
- Circuit is provided with battery back-up.
- Special Application

Figure 13. Auxiliary Connections Example

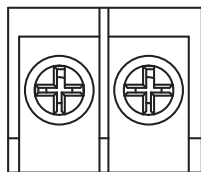

AUX

DWG #559-17

Section 4: Operation

This section provides an overview of the control panel’s basic operations, which includes the status LEDs, function pushbuttons, and a Control Panel Menu Tree quick reference sheet.

Control Panel Basic Operation

The control panel is comprised of a two (2) line x 16-character LCD display panel, arrow keys, push button function keys, status LEDs, and the numeric keypad. A description of each component is included in this section; please refer to the figure shown below.

Figure 14. PFC-6006 Control Panel Display

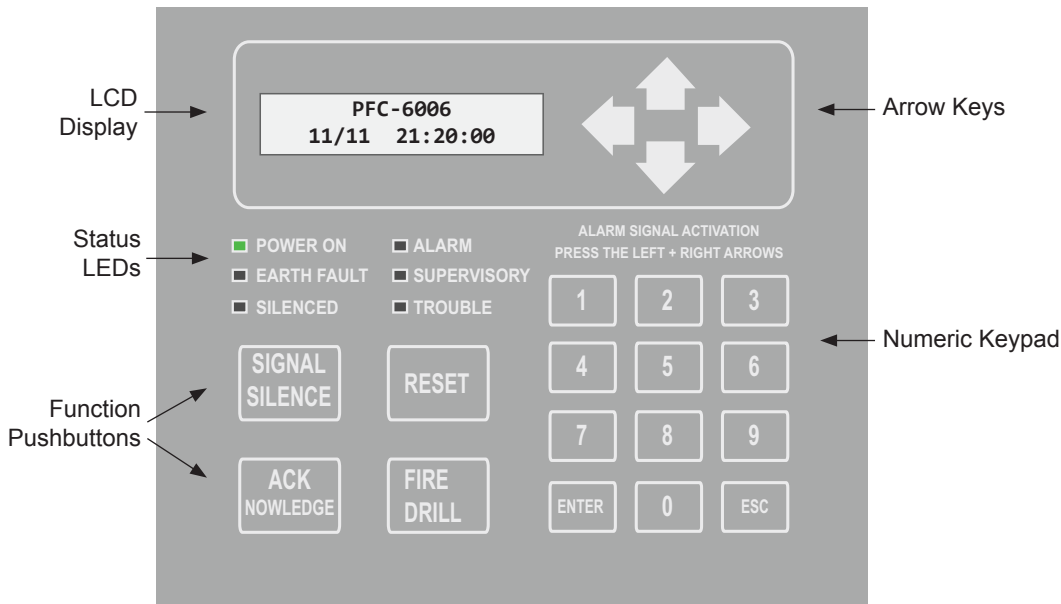

Note: Authorized system operators must use a key to open the outer door of the cabinet.

LCD Display

The LCD panel displays the standard *Start-up menu* as shown below. The LCD displays up to thirty-two (32) characters of information displays, providing important feedback to system users, i.e., system messages, status information, trouble conditions, or input changes. The LCD also provides access to the Main Menu for daily system operations and specific programming functions (refer to “Section 5: Programming – Menu Functions” for details on these topics).



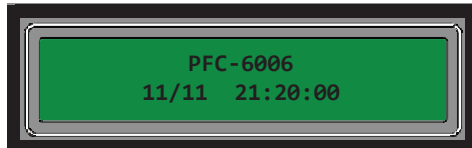

Figure 15. LCD Start-Up Screen



Note: You may customize the Start-up screen to display a specific job site name or other relevant descriptive text.

Menu Navigation Keys

The **arrow keys** allow you to scroll or move through the control panel menus. The **Enter** and **Esc** keys may also be used to navigate through menus; they are located on the numeric keypad. The table shown below provides a summary of the navigation keys.

Table 6: Menu Navigation Keys	
Push button	Description
	Moves/scrolls up or down through menus.
	Scrolls to the left or right to display details, if any, of current menu item. Note: When the LCD panel displays a LEFT and/or RIGHT arrow, this indicates more information may be viewed.
	Displays the Main Menu or selects the current menu option. Note: The blinking “→” indicates the current menu option.
	Returns to previous menu or backs up to previous screen.

Numeric Keypad





The numeric keypad allows you to enter user codes when required to access restricted functions. Alternatively, the numbers may be used to quickly select menu options vs. using the arrow and Enter keys to select a function.

Figure 16. Control Panel Numeric Keypad



Function Pushbuttons

The four (4) function pushbuttons are used when system alarm / trouble conditions occur or to perform a fire drill. Refer to the table below for a brief summary of the pushbuttons:

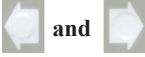
Table 7: Control Panel Pushbuttons	
Pushbutton	Description
	Press to <i>acknowledge</i> the currently displayed condition.
	Press to <i>silence</i> all outputs programmed as <i>silenceable</i> and buzzer.
	Press to <i>reset</i> panel to <i>normal condition</i> .
	Press to begin a fire drill.
	Press Left & Right Arrows at the same time for Alarm Signal Activation

Status LEDs

The control panel’s LEDs communicate system conditions by illuminating and/or flashing the applicable **green, red or amber** indicators. These are described in the table below.

Figure 17. Control Panel Status LEDs

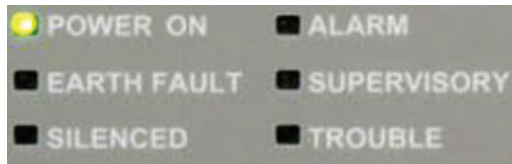

Table 8: Status LEDs

LED Type	LED Color/Action	Description
POWER ON	Steady Green	Power is present. Note: If power is absent for more than 5 seconds, LED will extinguish.
ALARM	Flashing Red	An alarm device is active.
ALARM	Steady Red	An alarm device is acknowledged.
EARTH FAULT	Flashing Amber	A ground fault is present.
SUPERVISORY	Flashing Amber	A supervisory condition is present.
SILENCED	Steady Amber	A fault condition has been silenced.
TROUBLE	Flashing Amber	A fault condition is present.

The panel events display according to the *priority* of the event. As additional events of a higher priority occur, the display automatically adjusts to show the *highest priority event first*, then moves lower priority events to the right and/or wraps down to the 2nd line. Up to two (2) lines of events may display. Refer to the examples below.

Examples:

1. Display shows *Trouble (TBL:) conditions* present on *Inputs 2 & 3*.

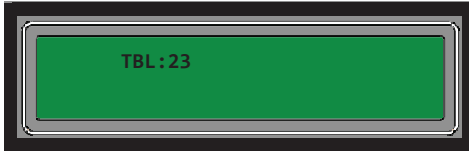

2. Display shows an *Alarm (ALM:) on Inputs 5 & 6*, as shown on line #1; all *Troubles (TBL:)* moved to the right automatically. The *TBL:"E"* shows that an *Earth Ground condition* is present, along with the *Troubles on Inputs 2 & 3*.

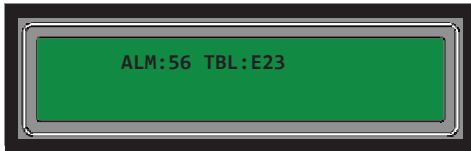

3. Display shows that a *Supervisory condition* is present on *Input 2* as shown *after* all Alarms on line #1. Notice that the *Trouble on Input 2* has been removed. All *Troubles* are pushed to the 2nd line of the display, where "*TBL:BE3*" reflects that a *Battery Trouble condition* is present, along with the *Earth Ground (E)* and *Input 3 Troubles*.

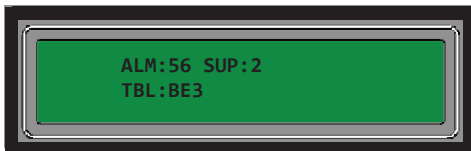

Notes:

- Input 1 may only be configured as *Alarm* or *Supervisory* types. Therefore, Input 1 displays only as an *Alarm* or *Supervisory* condition.
- The 1st line displays only **ALM:** and **SUP:** followed by the inputs of that type active. Only the number of inputs active will be displayed. If none of the **Alarm (ALM)** inputs are active, the display will only show **SUP:** followed by the active input.
- Authorized users may use arrow keys to navigate through active conditions and/or see detail information, such as custom messages, time and date of the event.

Control Panel Menu Tree

This section provides a reference to menu options as they appear on the LCD panel. Appendix G also provides a copy of the menu tree.

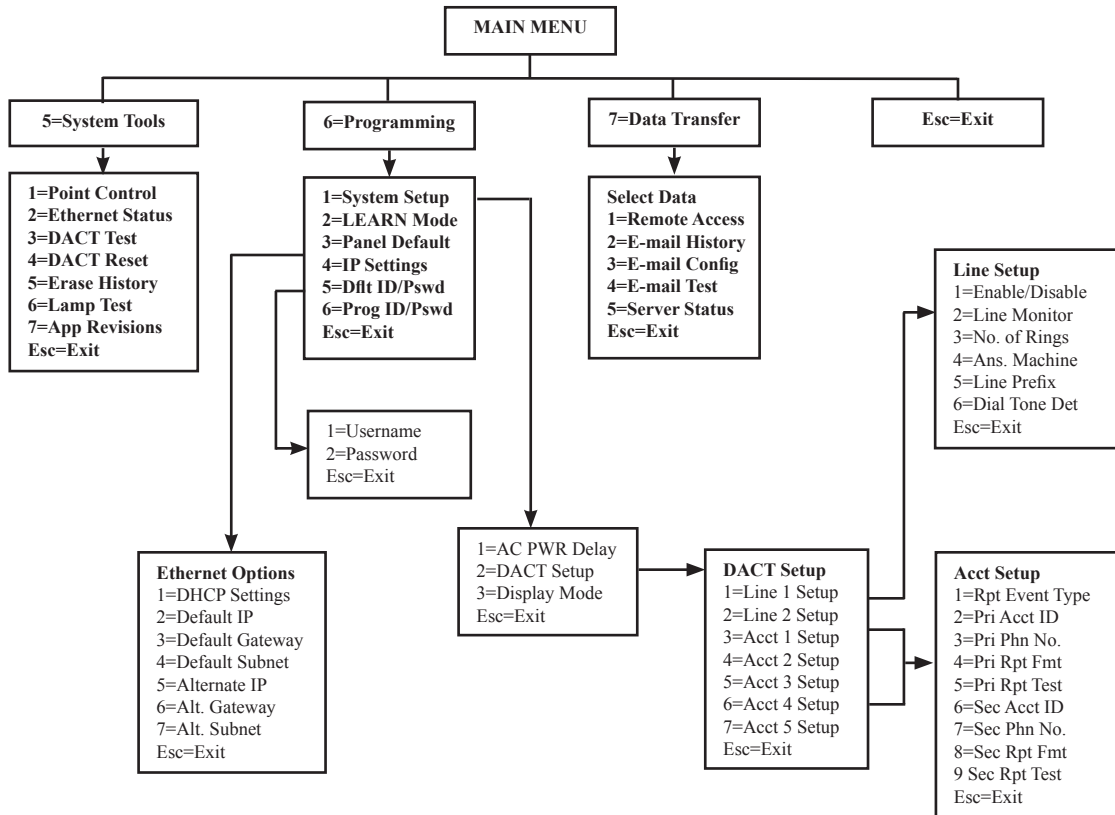
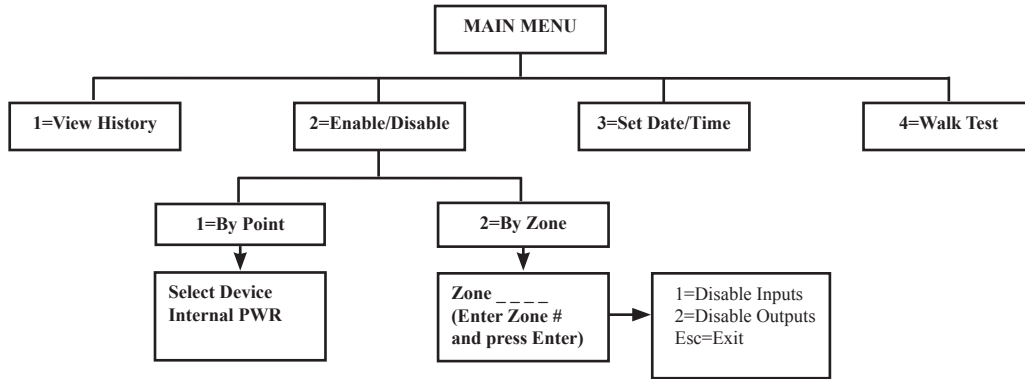

TIP: To save time, enter the menu selection number on the keypad to select a function. For example, press “3” to select “Set Date/Time” from the Main Menu.

Section 5: Programming

This section addresses programming options and their parameters, provides an overview of the programming process, and addresses how to use the two programming methods: (1) the **LEARN** function, and (2) the **remote computer programming process**. The LEARN function allows the addition and removal of remote annunciators.

This section also includes procedures on uploading and downloading configuration data using the **panel configuration software**. Please refer to this section to learn how to navigate within the software, access and modify programming settings, such as the system clock, displaying events, and programming optional remote annunciators or the IP Communicator, if installed.

Programming Options

NOTICE

To users, installers, authorities having jurisdiction, and other involved parties:

This product incorporates field-programmable software. In order for the product to comply with the requirements in the Standard for Control Units and Accessories for Fire Alarm Systems, UL 864, certain programming features or options must be limited to specific values or not used at all as indicated below.

Table 9: Programming Options

Topic	Feature or Option	Permitted in UL (Y/N)	Possible Settings	Setting(s) Permitted in UL864?	Comment
Misc	Idle LCD Message	Y	Yes/No	All settings allowed	
Misc	Display Events	Y	Initial Event Newest Event	Initial Event	Auto display of first event
Misc	Waterflow Delay	Y	0-255 Sec	0-90 sec	
Misc	AC Report Delay	Y	0-30 Hours	1-3 Hours	For UL864 use 1-3 Hr
Misc	DH Low AC Dropout Delay	Y	No delay, 15 sec, 1 minute, 5 minute	All settings allowed	
Misc	Auto Test Time	Y	Time of Day	All settings allowed	
Misc	Strobes Active When Silenced	Y	Yes/No	All settings allowed	
Misc	Display AM/PM	Y	AM/PM, 24 Hour	All settings allowed	
Misc	Time Zone	Y	24 Time Zone Selections	All settings allowed	
Misc	DST Enabled	Y	Yes/No	All settings allowed	
Misc	DST Start	Y	Month/Day	All settings allowed	
Misc	DST End	Y	Month/Day	All settings allowed	
Zone	Zone Style	Y	Alarm Supervisory Auxiliary Fire Drill System Alarm System Supervisory System Trouble	All settings allowed	

Table 9: Programming Options

Topic	Feature or Option	Permitted in UL (Y/N)	Possible Settings	Setting(s) Permitted in UL864?	Comment
Zone	Silenceable	Y	Yes/No	All settings allowed	
Zone	Silence Inhibit	Y	Yes/No	All settings allowed	
Zone	Auto Silence	Y	Yes/No	All settings allowed	
Zone	Auto Unsilence	Y	Yes/No	All settings allowed	
Zone	Restore Delay	Y	0-300 Sec	Full range allowed	
Zone	Latching	Y	Yes/No	All settings allowed	
Zone	Local	Y	Yes/No	All settings allowed	
Zone	Output Pattern	Y	Constant ANSI Temp 3 March Code Double Time		
Input Point	Dry Contact Input Functions	Y	Water Flow, Pull Station, Supervisory, Tamper, Fire Drill, Trouble Monitor, General Alarm, Conventional Smoke, Conventional Heat	All settings allowed	Applies to all input points and circuits.
Input Point	Supervisory	Y	Yes/No	All settings allowed	
NAC	Function	Y	Potter/AMSECO Sync Gentex Sync System Sensor Sync Wheelock Sync General Purpose	All settings allowed	Specifies use of NAC circuit
On-Board DACT	Daily Test Call	Y	Any time of day	All settings allowed	Alternates between line 1 and 2 if line 2 is enabled.
E-Mail	E-mail Status Reports	N	Alarms, Troubles, Supervisory Test & History		
IP-Dialer	IP Based Central Station Reporting	Y	Alarms, Supervisory, Trouble & Test Reports	All settings allowed	
AUX	Function	Y	Constant, Resettable, Door Holder, Door Holder Low AC Drop	All settings allowed	

Programming Overview

The **LEARN** function is available through the control panel, and is an efficient way to automatically configure remote annunciators. **LEARN** detects all connected P-Link devices, assigns a name and selects the applicable device type.

The **panel configuration software** allows custom programming and configuration for all points via a network or remote computer. At the click of a mouse, you may fine-tune device behavior characteristics or create mapping zones for a more sophisticated fire protection system. By using the system software, you will realize the power and flexibility of the PFC-6006 system. (*Please refer to "Panel Software Overview" and "Mapping Zones" in this section for details on these procedures.*)

The Programming Cycle

The following is a recommended approach to programming the system, if not using the default set up:

1. Install Software
2. Connect Ethernet Cable
3. Upload Data to Computer
4. Program the System
5. Download Configuration File

Note: This approach may eliminate programming errors, however, these are only recommendations.

Software Installation

It's easy to install the PFC-6006 software and requires only a few minutes to complete. Once done, the program automatically creates a shortcut icon on your desktop for easy access.

The system software is compatible with Windows XP, Windows Vista and Windows 7 Operating Systems, and incorporates conventional shortcuts and features (*i.e., right click to display shortcut menus, drag and drop, etc.*). The software's flexibility enables you to effectively program individual and/or groups of points. Several examples in configuring a basic fire system are provided later in this section under the "*System Programming*" heading.

Note: The latest version of Microsoft .NET Framework is required.

To install the software:

- Access the Potter website at: <http://www.pottersignal.com/>
- Locate the "Search" box shown in the upper right corner of the web page, and type in "PFC-6006."



- Scroll down to the "*Software*" section, and click on the .exe or .zip link located beneath "*Download*" to install software.
- The default installation directory is: *C:\ProgramFiles\Potter\Potter Fire Panel Programmer.*
- You may change the location of the application files.

LEARN Programming

The LEARN mode enables you to efficiently configure all connected, addressed Remote Annunciators. Only authorized users may access this function. LEARN generates a list of all remote annunciators, which may be viewed on a remote computer. (Refer to the “Configuring Points” and “Mapping Zones” sections for details.)

To run the LEARN mode:

- From the control panel, press the **Enter** button to display the Main Menu.
 - Press **6** to select **Programming**. The “Enter Code” prompt displays.
 - Enter the user code as prompted.
 - Press **2** to select **LEARN**. The “P-Link Initializing” prompt displays, and the system begins the initialization process.
- Results are grouped by **device type**. If no changes are detected, the prompt “No changes” displays.
 - Use **down arrow** to scroll through results by device type:
 - 1**=P-Link Found
 - 2**=P-Link Removed
 - Esc**=Exit
 - Select **Esc** when finished reviewing results. The system prompts to save or discard file.
- Press **1** to **save** changes; press **2** to **discard** changes.
 - If option **1** is selected, the “Accept confirmation” prompt displays.
 - Press **Enter** to accept or **Esc** to discard.
- Press **Esc** to exit programming menu.

Connecting the Computer and Panel

This section provides instructions on setting up connectivity between a laptop or networked computer and the control panel. Once this is achieved, you may program your system using the panel configuration software.

Note: These instructions are relevant to all system configurations. If your PC connects directly to the panel, any procedural differences are noted throughout.

Connecting a Computer to the Panel via a Network:

- Connect cable to the Ethernet port on network (or directly to the panel if not using a network).
- Connect Ethernet cable to port as shown below.

Figure 18. Control Panel Showing Ethernet Port

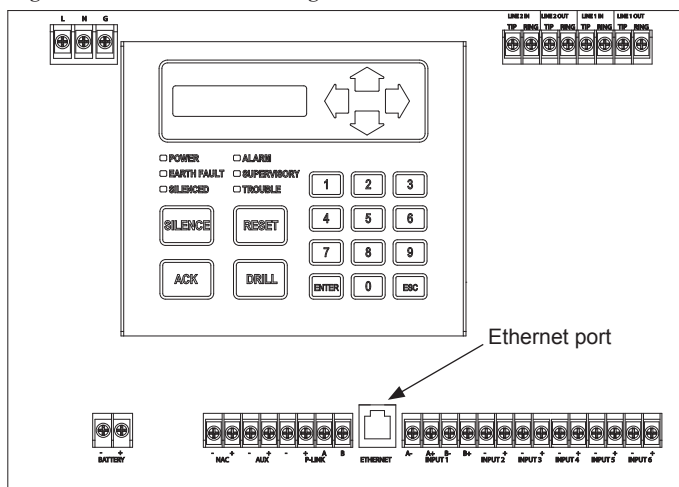

DWG #559-7

The following series of messages display on the LCD:

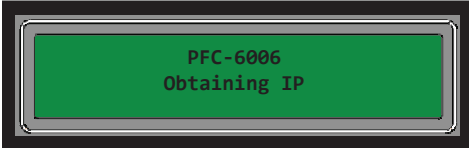
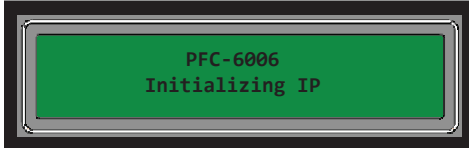

Notes:

- If the Ethernet cable is connected to PC, you will see the *"Initializing IP" message* prior to the *"Obtaining IP" message*.
- If your PC is connected directly to the panel, the *"Obtaining IP" message* displays for approximately 45 seconds, followed by the *"Private IP" message* (the *"Private IP" message is not shown here*).

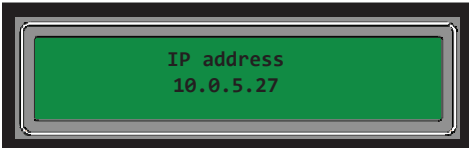

Note: The number "10.0.5.27" shown above represents an example of a panel's IP or identifier used for illustration purposes only. The panel's IP is unique to each computer / network. Write down the **IP address**; it is required to transfer programming data between the panel and the computer.



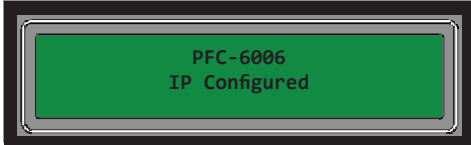

3. The *"IP configured"* and *"IP address"* prompts alternatively display until configuration is completed.



Note: If Ethernet connectivity is lost, the message *"Ethernet Lost"* displays on panel. This indicates that the Ethernet cable is disconnected at the panel or network (computer) port.

Transferring Data

This section provides step-by-step instructions for completing uploading and downloading data transfers. The "Transfer" icons are located at the top of the **Programmer window** and are briefly described below.

Icons	Description
	Downloads configuration file from computer to panel.
	Uploads configuration file from panel to computer.
	Uploads history events file from panel to computer.
	Prints selected file.

The **Transfers region** is located at the bottom of the Programmer window and lists all completed transfers. This area displays transfer details, including their date and time. You may also access the "Transfer" shortcut menu from this location to select any of the transfer functions.

Figure 19. Example of Programming Window Showing Transfer Icons and Transfer Section

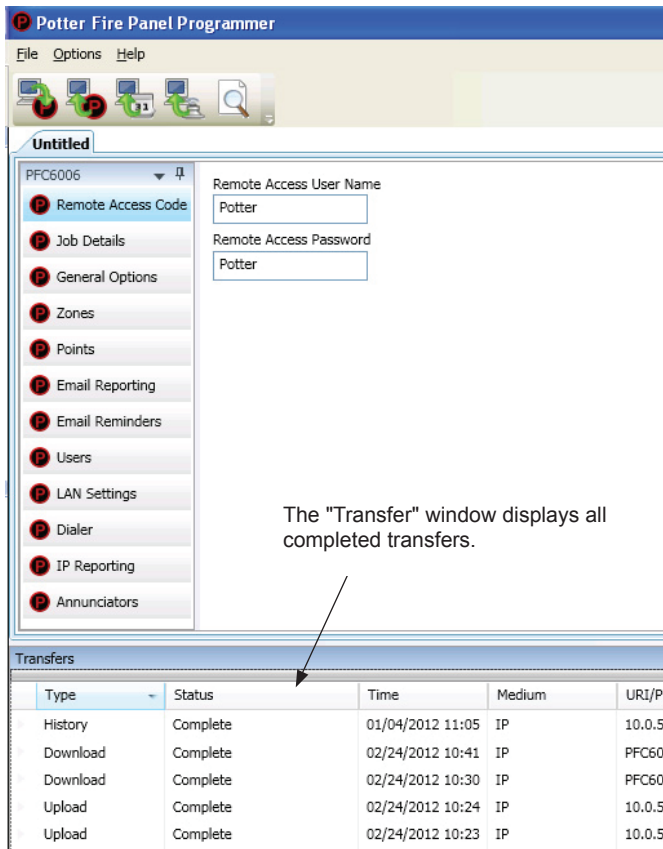

Note: Double-click anywhere on the transfer record to view details.

Uploading from Panel to Computer

The **Upload Configuration File to Computer transfer icon**  is used to upload the configuration file from the panel to the computer once the LEARN function is completed or whenever points are added or removed from the panel.

To upload programming changes to computer:

1. Click the **Upload Configuration File to Computer icon** or right click from **“Transfers” region** as shown below:

Figure 20. Example of Transfer Shortcut Menu

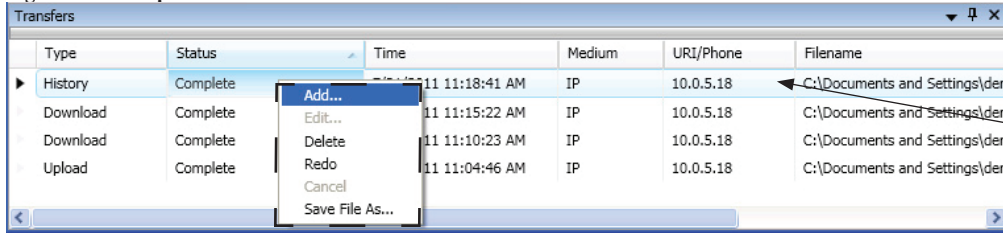

Right click anywhere in the transfer window to display the shortcut menu.

Note: Click the *“Add” option* from the shortcut menu to choose the transfer type.

The **Transfer dialog box** displays.

Figure 21. Example of Transfer Upload Dialog Box

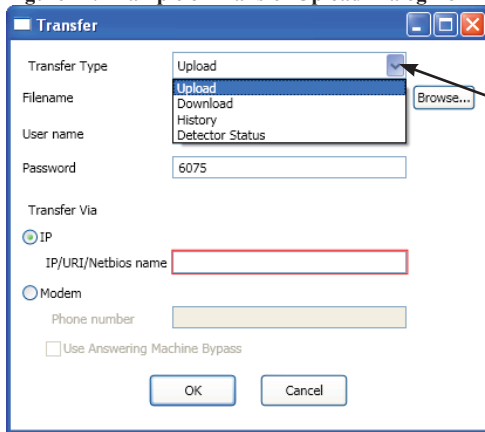

Click here to choose applicable transfer type, if necessary.

2. Verify that **Upload** is selected in the *“Transfer Type” field*.
3. Enter the **configuration filename** in the *“Filename” field* or leave blank to Autaname.

Figure 22. Example of Transfer – Upload Window

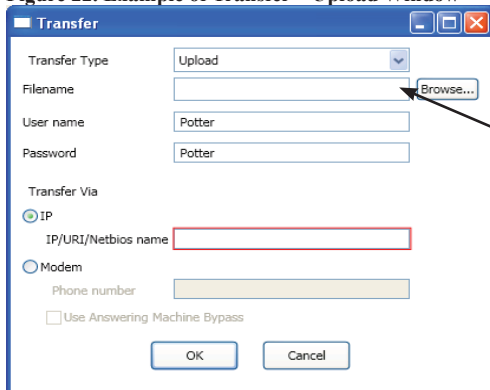

Enter file name or leave blank to auto-name.

Notes:

- If you do not name the file, the program automatically names it using the transfer type and date stamp as the file name.
- Once the file has been saved, and additional programming changes are made at a later date, click the **Browse button** to locate the file name to replace the old file with the updated configuration changes.

4. Enter **IP address** or **panel name** in the “*Transfer Via IP*” field.

Notes:

- To capture your panel’s unique IP address, disconnect the Ethernet cable from panel. The message “**Ethernet Lost**” displays indicating connectivity is lost. Be prepared to write down the address, and reconnect cable.
- If you are connecting via a modem, please refer to “*Appendix B: Modem Connectivity Setup*”.

5. Click **OK**. The **Transfers** region displays the uploaded file.

Figure 23. Example of Transfers Download Results

Transfers				
▶ Upload	Complete	11/8/2010 3:48:08 IP	PFC6075R0000006	Config 2010-11-08 15-48-03-36.vcf

- Double-click on the transfer file to display results.
- All points detected during the LEARN process have been uploaded to the panel configuration software.

Note: Details on viewing and configuring points are addressed in detail later in the “*System Programming – Configuring Points*” topic.

Downloading Configuration File to Panel

The **Download Configuration File to Panel** icon  allows you to copy all programming changes to the panel.

Notes:

- Be sure to “*Enable Remote Access*” at the panel before choosing this option. If your PC is directly connected to the panel versus a network, this step is not necessary.
- Verify that the *Remote User Name and Password* match the panel’s user name and password. You will receive an error message when attempting to download data to the panel if they do not match.

Enable Remote Access

To enable remote access:

1. At control panel, press **ENTER** to display the **Main Menu**.
2. Press **7** to select **Data Transfer**.
3. The “**ENTER CODE**” prompt displays. Enter the user code to continue.
4. The **Select Data option** displays. Press **1** to select **Remote Access**.
5. Press **ESC** to return to **Main Menu**.

Note: Once enabled, the remote access will “time out” after thirty (30) minutes if contact is not established.

File New

The **File New menu option** is used to complete all programming from scratch on the computer. You must select the correct panel model prior to programming.

Note: It is imperative that you choose the correct panel model **prior** to programming or completing any data transfers, otherwise, you cannot complete a successful download to the panel. If this occurs, you will have to reprogram the entire panel.

Figure 24. Example of File New Dialog Box

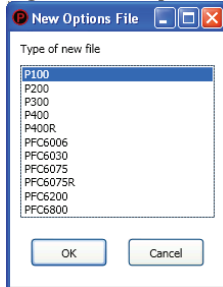

File Save / Save As

Once programming has been completed, save your configuration file using either the **"File – Save" or "File – Save As" function**. An *audit* is performed that checks for rule violations; if errors are encountered, you may choose to either save with errors or cancel the save operation.

Figure 25. Example of Save Panel Dialog Box

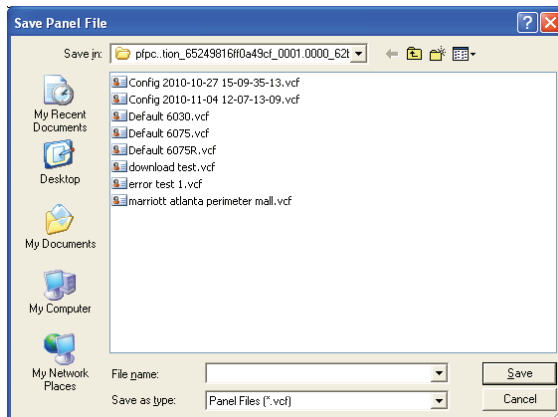

Notes:

1. All site specific configuration data is stored in the panel's non-volatile memory.
2. The next time you make programming changes, you may overwrite the original configuration file with changes. If you choose to do this, you will lose the original programming report information.
3. The panel configuration file has a .fpcf file extension.

Audit Errors

The *Audit Error - Save Anyway? dialog box* displays if programming errors are encountered when saving the configuration file. You may choose to save the file with errors; however, you cannot download the data until all errors are corrected.

Figure 26. Example of the "Save anyway?" Dialog Box

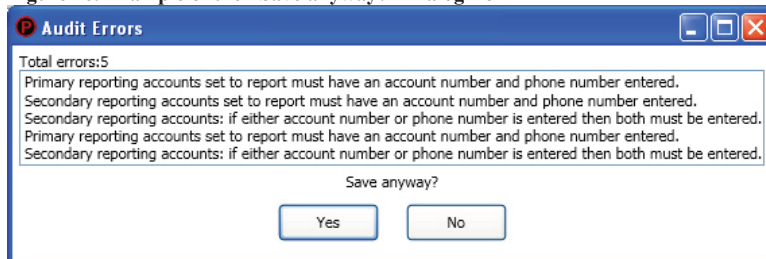

Downloading a Configuration File

To download the configuration file:

1. Click the **Download Configuration File to Panel** icon  or **right click** from the **“Transfers”** region, then click **“Add”**. The **Transfer dialog box** displays.

Figure 27. Example of Transfer – Download Dialog Box



2. Verify that **Download** is selected in the **“Transfer Type”** field.
3. Enter the file name in the **“Filename”** field or click the **Browse** button to select file name.
4. Enter the **IP address** in the **“Transfer Via IP”** field.

Figure 28. Transfer - Download Dialog Box

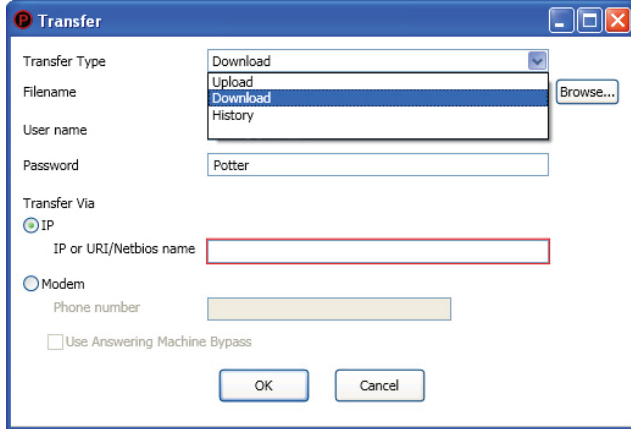
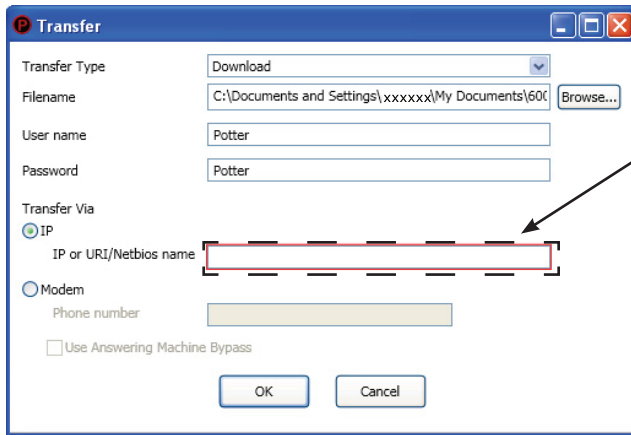

Note: To capture the panel's unique IP address:

1. Disconnect the Ethernet cable from panel.
2. The message “Ethernet Lost” displays indicating connectivity is lost.
3. Reconnect the cable, and write down the IP address shown.

5. Click **OK**. The **Transfers window** displays the transfer progress.

Figure 29. Example of Transfers Window Showing Download Completed

Type	Status	Time	Medium	URI/Phone	Filename
History	Complete	7/21/2011 11:18:41 AM	IP	10.0.5.18	C:\Documents and Settings\de
Download	Complete	7/21/2011 11:15:22 AM	IP	10.0.5.18	C:\Documents and Settings\de

Uploading History Events Status Reports

The **Upload History File to Computer** icon allow you to view valuable information that can be essential when analyzing system operations. You may choose to print the History reports by using the **Print** icon; reports can be scheduled to be automatically sent to authorized e-mail addresses. Refer to the *"System E-mail Functions"* topic located later in this section for details on programming this e-mail reporting option.

History Reports

The *"Event History" transfer option* creates a report of all events held in the panel's buffer. Up to 1,000 events are held in the buffer at one time. This information may be used to troubleshoot errors or to assess ways to improve the system configuration.

To transfer event history information:

1. Click the **Upload History File to Computer** icon  or **right click** from *"Transfers" area*, and click *"Add"*. The **Transfer dialog box** displays.
2. Verify that **History** is selected in the *"Transfer Type" field*, and click **OK** to display results.

Figure 30. Transfer Window Results

Type	Status	Time	Medium	URI/Phone	Filename
History	Complete	7/21/2011 11:18:41 AM	IP	10.0.5.18	C:\Documents and Settings\de
Download	Complete	7/21/2011 11:15:22 AM	IP	10.0.5.18	C:\Documents and Settings\de
Download	Complete	7/21/2011 11:10:23 AM	IP	10.0.5.18	C:\Documents and Settings\de
Upload	Complete	7/21/2011 11:04:46 AM	IP	10.0.5.18	C:\Documents and Settings\de

3. Double-click file to view results.

Figure 31. Example of Transfer Results Window

Date/Time	Event
08/01/2011 02:00:00 AM	System Auto Test Normal
07/31/2011 02:00:00 AM	System Auto Test Normal
07/30/2011 02:00:00 AM	System Auto Test Normal
07/29/2011 02:00:00 AM	System Auto Test Normal
07/28/2011 02:00:00 AM	System Auto Test Normal
07/27/2011 02:00:00 AM	System Auto Test Normal

Note: Click the **Print**  icon to print a copy of the report. Refer to *"Printing Reports"* located in this section for more details.

4. Click the **close button** to close report.

Note: Refer to *"System E-mail Functions - Receiving E-mail Status Reports"* located in this section for a sample of a History Events Report sent via e-mail.

Printing Reports

The **Print**  icon allows you to print History reports. Double-click the **History** file listed in the **Transfer window** prior to clicking the Print icon. An example of the **Report window**, which displays a History report, is shown below:

Figure 32. Example of the History Report (Print) Window



To print a History Report:

1. Double-click the History report listed in the Transfers window to display the report.
2. Adjust the width of the "Event" column to display the entire descriptions otherwise the "Event" information will be truncated on the printed report.

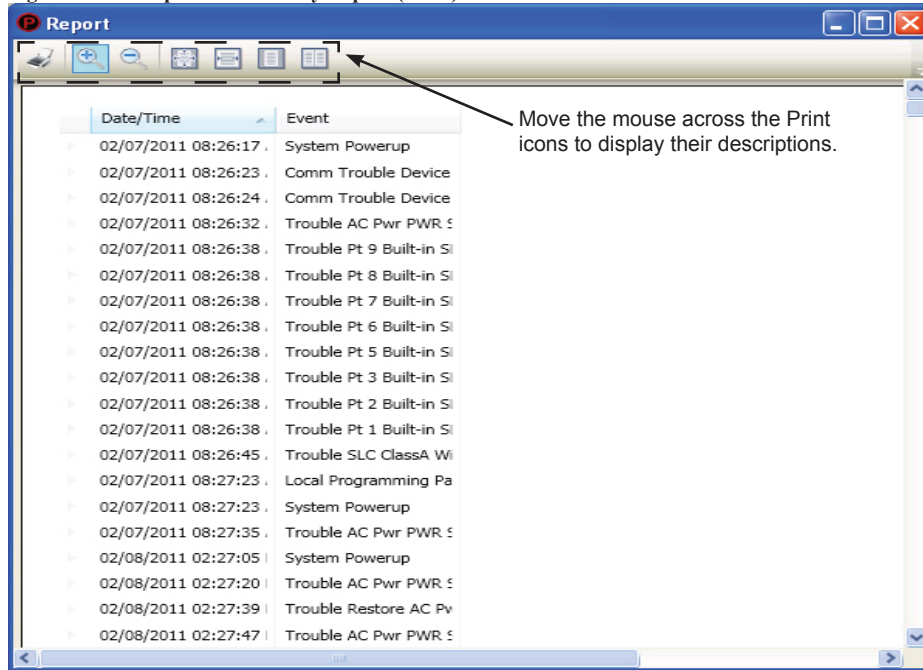
Tip: Double-click on the Event column's border to automatically expand the width to accommodate the longest description. Refer to the example below:

Figure 33. Example of the History Report

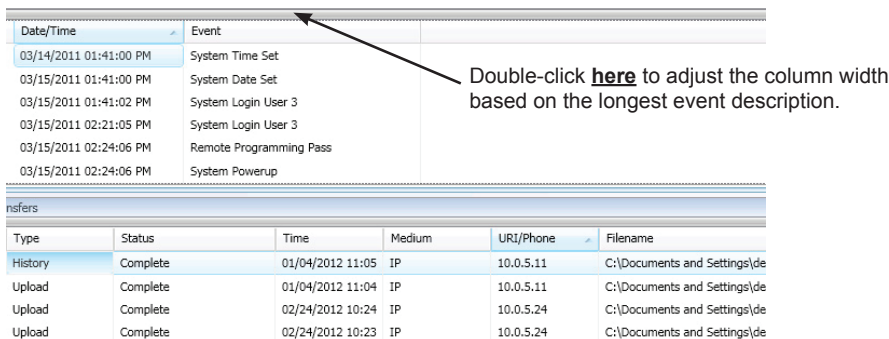

3. Click the **Print**  icon, then click the **Report Print**  icon or **CTRL P** to open the print dialog box.
4. Click the **Print button**.

Panel Software Overview

This section gives you an overview of the Panel Configuration Software. It addresses navigating through the program windows, understanding the purpose of icons and program features, using Window's conventional editing techniques and other program shortcuts to efficiently configure your system.

Window Regions / Areas

When you select a function from the **Panel window**, the related information displays on the right. Additionally, the selected function is highlighted, which helps direct your eye to the function's related screen information. For example, when "**Remote Access Code**" is selected, the *remote user name and password* displays. Please refer to the examples shown below.

Figure 34. Panel Menu Options

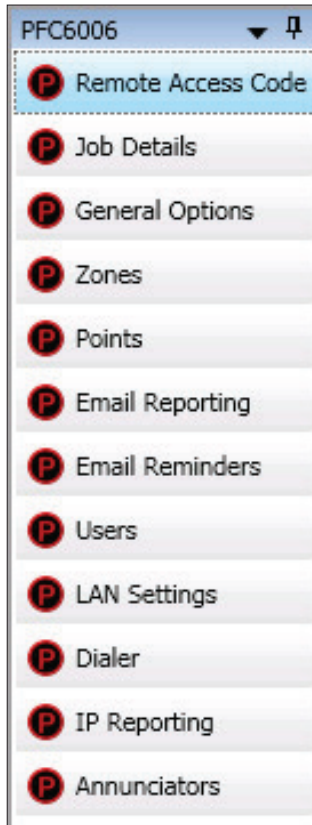
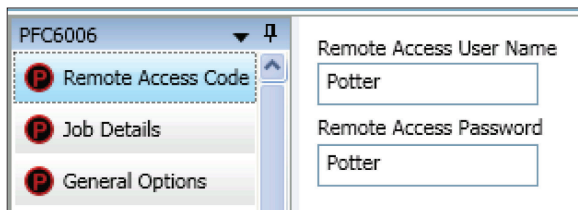





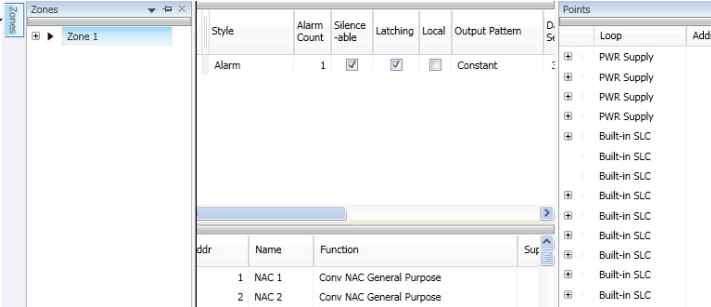

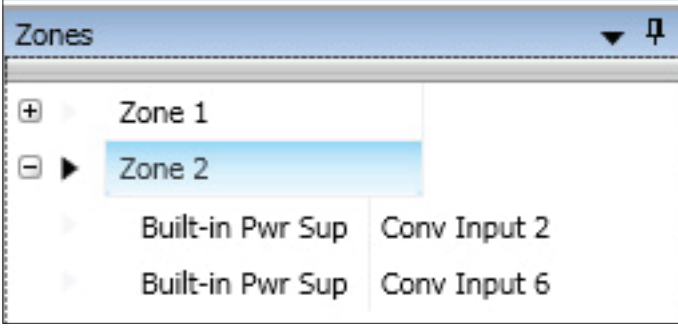

Figure 35. Example of Remote Access Code



Program Icons

The panel software uses several standard Windows’ icons, such as the close button and scroll bars. There are others that are unique to the panel software, such as auto hide, and window position which are summarized in the table below:

Table 11: Panel Configuration Icons		
Name	Icon	Description/Function
Window Position		<p>Located in the upper right region of some windows. Click the icon to choose an option:</p> <ul style="list-style-type: none"> Floating – window floats over other windows; right-click title bar to reselect dockable. Dockable – <i>default</i> window position; window is “locked” in place. Auto Hide – window is hidden when cursor is moved and “tab” displays as window placeholder; point to window “tab” to redisplay (<i>Window Tab is explained below.</i>)
Auto-Hide		<p>Shortcut to hide a window.</p> <ul style="list-style-type: none"> Click  to hide window. Icon changes to  (insert window autohide if window is hidden. Click  to unhide and dock window.
Window “Tab”		<p>Displays if window is hidden; available for specific windows only.</p> <p>Note: “Tab” name is specific to the hidden window.</p> <ul style="list-style-type: none"> Point to “Tab” to display window. Point or click in another window to hide. <p>Example of Zone tab:</p> 
Expand / Collapse		<p>Available in Zones and Points windows only.</p> <ul style="list-style-type: none"> Click the "plus" sign to expand. Click the "minus" sign to collapse. <p>Example of expand/collapse icons in Points window:</p> 

Programming Functions Overview

The table below gives you a snapshot of the menu order along with a brief description of each. Details for these options are provided on the following pages.

Table 12: Programming Menu Overview	
Menu Option	Description
Remote Access Code	Displays remote access “ <i>User Name</i> ” and “ <i>Password</i> ”.
Job Details	Allows site specific information to be entered.
General Options	Allows software’s general panel settings to be customized, such as door holder low AC dropout delay, and display events type.
Zones	Define and configure zone’s characteristics and mapping points.
Points	Define and view all addressable and non-addressable points.
Email Reporting	Schedule e-mail reports by day and time, setup e-mail addresses, and select type of report(s) to send to each e-mail addressee.
Email Reminders	Create and schedule customized daily, weekly, monthly, or yearly reminder emails.
Users	Create up to ten (10) user codes and passwords, and set access rights.
LAN Settings	Configure Ethernet connectivity options.
Dialer	Configure the on-board DACT reporting accounts and phone options.
IP Reporting	Configure IP reporting options for primary and secondary accounts.
Annunciators	Add or remove Remote Annunciators.

Remote Access Code

The **Panel Configuration window** displays the remote access user name and password on the right section of the screen (*refer to the example shown below*).

Figure 36. Example of the Panel Configuration Screen

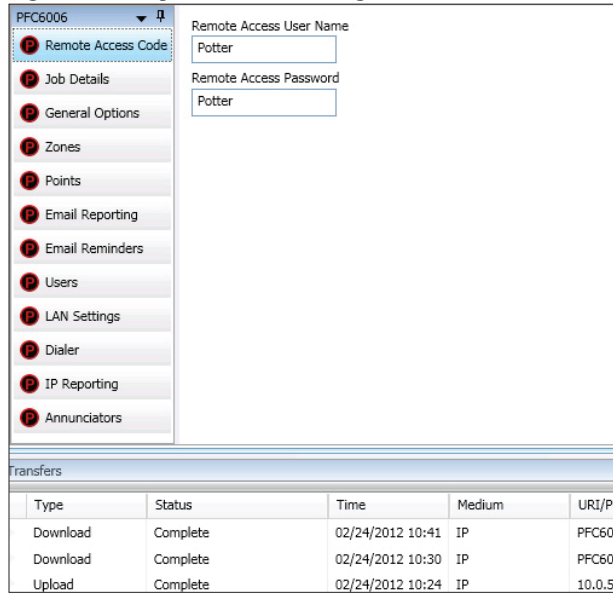

User Name / Password

The default **user name** and **password** is “*Potter*” as shown below; they can be changed to ensure that only authorized personnel can transfer data to and from the panel.

Figure 37. Remote Access Code Screen

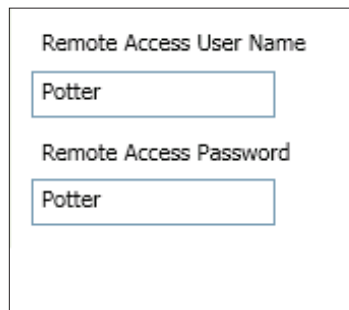

Notes:

1. The remote access user name and password may be changed to increase security on the system.
2. The remote user name and password must match the panel’s user name and password.

General System Functions

Job Details

Site specific information, such as company name, address and phone numbers may be entered in this window. This information is stored in the panel and is used to identify the panel when using e-mail reporting options. Please refer to the figure shown below.

To enter site information:

1. Click the **Job Details** program option. The *Job Details window* displays.

Figure 38. Job Details Window

Job Name	Potter Sprinkler Monitoring Panel
Address Line 1	5757 Phantom Drive
Address Line 2	Suite 125
Address Line 3	Hazelwood, MO 63042
Address Line 4	
Phone	1-800-325-3936
Phone 2	
Email	tech@pottersignal.com
Email 2	

2. Click in each applicable field to enter information.

Note: You may also press the **TAB** key to move to next field.

General Options

The *General Options window* contains a variety of general system settings, such as the panel’s default name, idle message, display events, and specific time the *Autotest* will be sent to the monitoring station. Refer to the figure below for an example of this window.

Figure 39. General Options Window

Panel Name	Sprinkler Monitoring Panel	Door Holder Low AC Dropout Delay	15 seconds	
System Idle Message	<input checked="" type="checkbox"/> Enable Idle Message PFC-6006	Time to Send Autotest	02:00 AM	
Default Outgoing Email Address	username@company.org	<input type="checkbox"/> Strobes Active When Silenced <input checked="" type="checkbox"/> Enable Power Line Clock Synchronization <input type="checkbox"/> Enable CO2 Tone (Temp-4) on Annunciators <input checked="" type="checkbox"/> Display Time as AM/PM	Time Zone	GMT-06:00 (CST:Central Standard)
Display Events	Initial Event	<input checked="" type="checkbox"/> Enable Daylight Savings Time Adjustment Daylight Savings Time	Month	Mar
Water Flow Delay (seconds)	30	Start	Day	Second Sunday
AC Report Delay (hours)	1	End	Month	Nov
			Day	First Sunday

Users

The **Users** option allows you to create up to ten (10) user profiles, if needed. Each profile may have different access rights, which controls the panel functions a user may access.

To create a new user:

1. Click on the **Users option**. The *User's Code window* displays.

Figure 40. Example of Users Profile Window

Name	User Code	System Reset	System Silence	Acknowledge	Fire Drill	Review History	Enable Disable	Set Date/Time	Walk Test	Tools	Programming	Data Transfer
Default Access		<input checked="" type="checkbox"/>	<input checked="" type="checkbox"/>	<input checked="" type="checkbox"/>	<input checked="" type="checkbox"/>	<input checked="" type="checkbox"/>	<input type="checkbox"/>	<input checked="" type="checkbox"/>	<input type="checkbox"/>	<input type="checkbox"/>	<input type="checkbox"/>	<input type="checkbox"/>
User 2	123456	<input checked="" type="checkbox"/>	<input checked="" type="checkbox"/>	<input checked="" type="checkbox"/>	<input checked="" type="checkbox"/>	<input checked="" type="checkbox"/>	<input type="checkbox"/>	<input checked="" type="checkbox"/>	<input type="checkbox"/>	<input type="checkbox"/>	<input type="checkbox"/>	<input type="checkbox"/>
User 3	1111	<input checked="" type="checkbox"/>	<input checked="" type="checkbox"/>	<input checked="" type="checkbox"/>	<input checked="" type="checkbox"/>	<input checked="" type="checkbox"/>	<input checked="" type="checkbox"/>	<input checked="" type="checkbox"/>	<input checked="" type="checkbox"/>	<input checked="" type="checkbox"/>	<input checked="" type="checkbox"/>	<input checked="" type="checkbox"/>
User 4		<input type="checkbox"/>	<input type="checkbox"/>	<input type="checkbox"/>	<input type="checkbox"/>	<input type="checkbox"/>	<input type="checkbox"/>	<input type="checkbox"/>	<input type="checkbox"/>	<input type="checkbox"/>	<input type="checkbox"/>	<input type="checkbox"/>
User 5		<input type="checkbox"/>	<input type="checkbox"/>	<input type="checkbox"/>	<input type="checkbox"/>	<input type="checkbox"/>	<input type="checkbox"/>	<input type="checkbox"/>	<input type="checkbox"/>	<input type="checkbox"/>	<input type="checkbox"/>	<input type="checkbox"/>
User 6		<input type="checkbox"/>	<input type="checkbox"/>	<input type="checkbox"/>	<input type="checkbox"/>	<input type="checkbox"/>	<input type="checkbox"/>	<input type="checkbox"/>	<input type="checkbox"/>	<input type="checkbox"/>	<input type="checkbox"/>	<input type="checkbox"/>
User 7		<input type="checkbox"/>	<input type="checkbox"/>	<input type="checkbox"/>	<input type="checkbox"/>	<input type="checkbox"/>	<input type="checkbox"/>	<input type="checkbox"/>	<input type="checkbox"/>	<input type="checkbox"/>	<input type="checkbox"/>	<input type="checkbox"/>
User 8		<input type="checkbox"/>	<input type="checkbox"/>	<input type="checkbox"/>	<input type="checkbox"/>	<input type="checkbox"/>	<input type="checkbox"/>	<input type="checkbox"/>	<input type="checkbox"/>	<input type="checkbox"/>	<input type="checkbox"/>	<input type="checkbox"/>
User 9		<input type="checkbox"/>	<input type="checkbox"/>	<input type="checkbox"/>	<input type="checkbox"/>	<input type="checkbox"/>	<input type="checkbox"/>	<input type="checkbox"/>	<input type="checkbox"/>	<input type="checkbox"/>	<input type="checkbox"/>	<input type="checkbox"/>
User 10		<input type="checkbox"/>	<input type="checkbox"/>	<input type="checkbox"/>	<input type="checkbox"/>	<input type="checkbox"/>	<input type="checkbox"/>	<input type="checkbox"/>	<input type="checkbox"/>	<input type="checkbox"/>	<input type="checkbox"/>	<input type="checkbox"/>

2. Double click in the “Name” field to enter a descriptive user name.
3. Click in the appropriate field selection boxes to grant access to that feature.
4. Repeat steps for up to 10 users.

Note: The access rights for the “Default Access” user code can be modified if needed.

NOTICE

System e-mail communications and functions are intended for informational reporting purposes only. They are intended to be used as a convenience function. E-mail communications should NOT be used as a primary means of reporting emergency information.

System E-mail Functions

The PFC-6006 comes with built-in e-mail capabilities. The panel automatically sends status e-mails, including Alarms, Troubles, Supervisory and Test events, to the e-mail addresses designated on the "E-mail Reporting" window as shown below.

Figure 41. E-mail Reporting Window

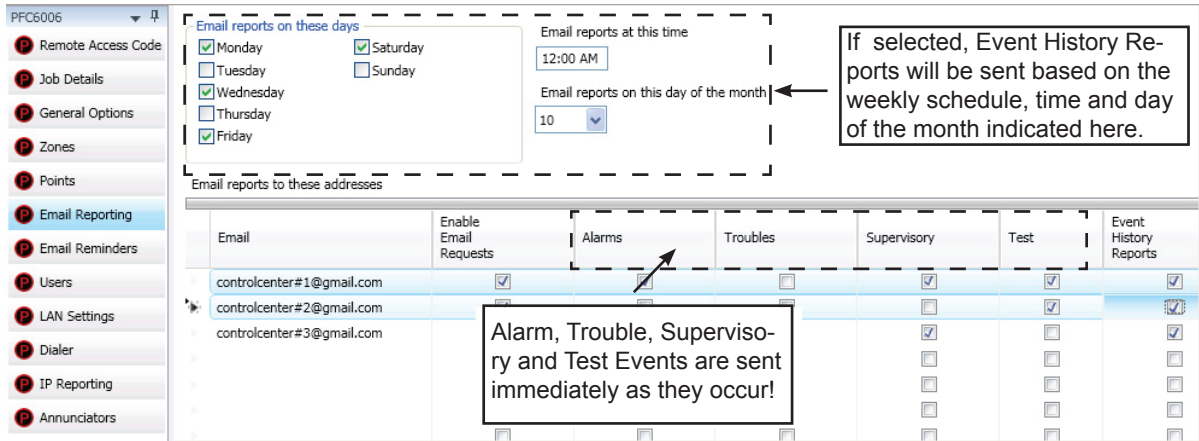

Event History reports may be scheduled to be sent on specific days of the week, time or day of the month. Up to twenty (20) e-mail addresses may be programmed on this screen. After the "E-mail Reporting" section is completed and downloaded into the panel, the panel will start sending e-mails according to programming.

The panel is capable of sending automatic and on-demand reports because it has a designated outgoing e-mail address comprised of its model and serial numbers. On-demand reports can be requested directly from the panel's "Data Transfer" function or remotely from a PC, if the user has a valid e-mail address programmed on the "E-mail Reporting" window.

The panel address is structured as: **PFC6XXXXXXXXXX@potterlink.com** where "PFC6XXXXXXXXXX" refers to the "panel serial number". The serial number is the same as the NetBIOS name, and is located on the panel as shown below.

Note: Outgoing panel e-mails are routed through a dedicated Potter server. You must make a notation of your panel's outgoing e-mail address in order to send e-mail requests remotely.

Figure 42. Panel Serial Number Location

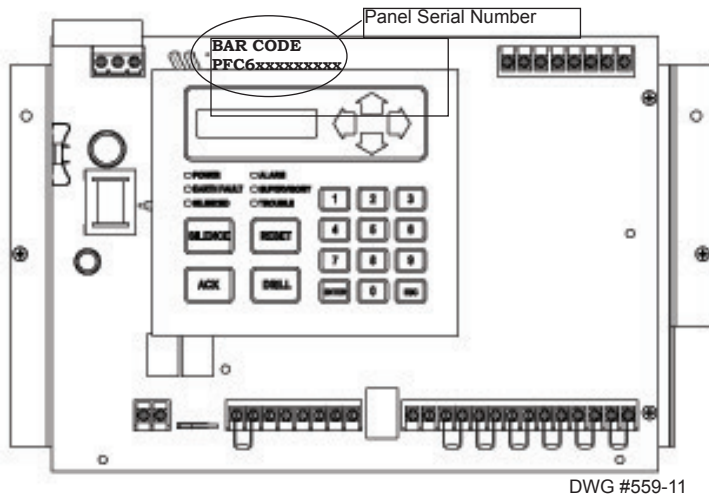

NOTICE

System e-mail communications and functions are intended for informational reporting purposes only. They are intended to be used as a convenience function. E-mail communications should NOT be used as a primary means of reporting emergency information.

P-Link E-mail Notification Requirements

The following table lists the necessary hardware and Internet connectivity requirements to use P-Link functions, such as DACT and e-mail notification.

Table 13: P-Link E-mail Notification Requirements	
Item	Requirement
Hardware	10/100 Mbps Ethernet Network
IP Address Protocol	DHCP or Static IP (factory default is DHCP)
Outbound Connectivity	Must have outbound access to Internet (mail server connections only). Port 10025 for SMTP Port 110 for POP3
Inbound Connectivity	None required or utilized.

Connecting the Panel to a Network

In order to use the e-mail feature, the panel must be connected to a network with Internet connectivity. This is usually accomplished by installing an Ethernet drop near the panel. The IP address can be set one of two ways:

- The panel has a built in DHCP (Dynamic Host Configuration Protocol) and will ask for an IP address from the "Host Computer".
- The installer or the Network Administrator may set the **IP address** using the software's Static IP function.

Figure 43. Setting the IP Address

The screenshot shows the 'Panel Network Settings' configuration page for a PFC6006 device. The left sidebar contains a menu with 'LAN Settings' selected. The main content area has two radio button options for IP configuration:

- Use DHCP:** This option is selected. It includes sub-options for 'Automatic Private IP Address' (selected) and 'User Configured Alternate IP'. Below these are input fields for IP Address (0.0.0.0), Subnet Mask (0.0.0.0), and Default Gateway (0.0.0.0). An arrow points to this section with the text: "Set the IP address using the DHCP function...or".
- Use Static IP:** This option is also selected. It includes input fields for IP Address (192.0.0.0), Subnet Mask (255.255.255.0), and Default Gateway (0.0.0.0). An arrow points to this section with the text: "Set the IP address using the Static IP function".

At the bottom, there are options for DNS configuration: 'Use DNS address from DHCP server' (unselected) and 'Specify DNS Address' (selected). Below these are input fields for Preferred DNS Server (0.0.0.0) and Alternate DNS Server (0.0.0.0).

NOTICE

System e-mail communications and functions are intended for informational reporting purposes only. They are intended to be used as a convenience function. E-mail communications should NOT be used as a primary means of reporting emergency information.

E-mail Report Programming

To setup History reports schedule:

1. Click on the **E-mail Reporting option**. The *E-mail Reporting window* displays.
2. Click in the *days of the week's selection box* to choose the days that the *History report(s)* will be sent.
3. Adjust *time*, if necessary.
4. Select a *day of the month*, if you wish reports to be sent on a specific day of each month.

Note: Be sure to select each report type in the next E-mail section for each recipient you wish to send these reports.

To setup addresses and select events and/or reports:

1. In the E-mail address section, as shown below, enter up to twenty (20) e-mail addresses, if needed.
2. Select the **"Enable E-mail Requests"** option if the e-mail addressee may request reports from the panel.

Note: If **"Enable E-mail Requests"** is not selected, the panel will ignore an e-mail request for an on-demand report.

3. Select each type of event(s) and/or report(s) you wish to send to the applicable e-mail address.
4. An "✓" displays in each selected report type.

Figure 44. E-mail Reporting showing Enable E-mail Request -- In Progress! will add text boxes!

E-mail Sent from Panel

To send a report from the panel:

1. Select the **Data Transfer (Menu Option 7)** on the panel menu.
2. Select one of the transfer options as described below:

Option	Description
1=Remote Access	Used to enable remote access
2=E-mail History	Allows user to e-mail a history file
3=E-mail Config	Allows user to e-mail a panel configuration file (.fpcf)
4=E-mail Test	Allows user to send a test e-mail
5=Server Status	Allows e-mail server status to be verified

NOTICE

System e-mail communications and functions are intended for informational reporting purposes only. They are intended to be used as a convenience function. E-mail communications should NOT be used as a primary means of reporting emergency information.

3. Select one or more e-mail address using one of the following options:
 - Choose "Use Default" to select the address entered in "General Options" (as shown below).
 - Choose "Browse List" to scroll through and select one or more e-mail addresses entered in the "E-mail Reporting" section of the software.
 - Choose "Specify New" to enter additional e-mail addresses, if needed.

Figure 45. Example of the General Options Window - Default Outgoing E-mail Address

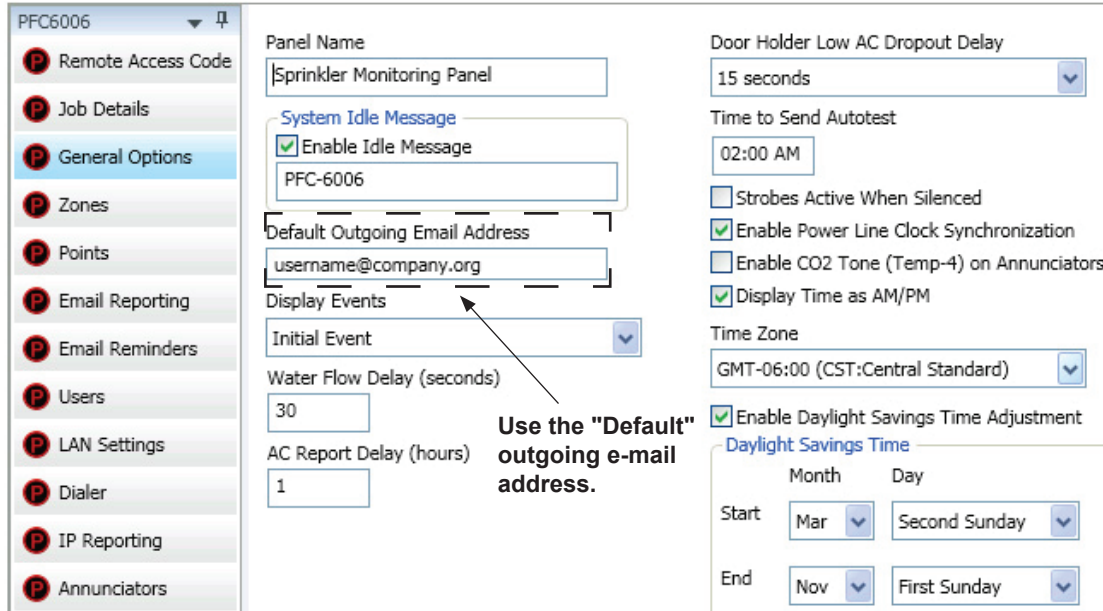

E-mail Report Requested from PC

To request a report from a remote PC:

1. Open or create a new e-mail.
2. In the "To" field, enter the panel's e-mail address as shown below. (Refer to the "Panel Serial Number Location" shown earlier in this topic.)

Figure 46. Example of Keywords in E-mail Subject Field



NOTICE

System e-mail communications and functions are intended for informational reporting purposes only. They are intended to be used as a convenience function. E-mail communications should NOT be used as a primary means of reporting emergency information.

3. In the “*Subject*” field, enter one or more of the following keywords:
 - *History* to send a current event history report back to sender.
 - *Configuration* to send a current configuration file back to sender.
 - *Unsubscribe* to stop the current e-mail settings for the sender until panel is reset or that e-mail address sends a “*Subscribe*” to the panel.
 - *Subscribe* to activate e-mail settings for the sender.

Note: Keywords are NOT case sensitive and more than one can be entered in the subject line of the e-mail.

4. There are no restrictions on contents entered into the body of the e-mail.

Important Reminders!

- The person sending the e-mail **must** be added to the e-mail list in the “*E-mail Reporting*” section of the software as shown below. If the sender is not in the list, the panel will not respond.
- The “*Enable E-mail Requests*” option must also be checked for the sender to receive e-mails when requested from the panel or a remote PC.

Figure 47. E-mail Reporting Window

Note: You may choose not to select a specific event type or report for an e-mail address. If so, choose **Browse List** from the Data Transfer panel menu option. Then scroll through e-mail addresses and select one or more recipients.

Email	Enable Email Requests	Alarms	Troubles	Supervisory	Test	Event History Reports
controlcenter#1@gmail.com	<input checked="" type="checkbox"/>	<input checked="" type="checkbox"/>	<input type="checkbox"/>	<input checked="" type="checkbox"/>	<input checked="" type="checkbox"/>	<input checked="" type="checkbox"/>
controlcenter#2@gmail.com	<input checked="" type="checkbox"/>	<input type="checkbox"/>	<input type="checkbox"/>	<input type="checkbox"/>	<input checked="" type="checkbox"/>	<input type="checkbox"/>
controlcenter#3@gmail.com	<input checked="" type="checkbox"/>	<input checked="" type="checkbox"/>	<input checked="" type="checkbox"/>	<input checked="" type="checkbox"/>	<input type="checkbox"/>	<input checked="" type="checkbox"/>
	<input type="checkbox"/>	<input type="checkbox"/>	<input type="checkbox"/>	<input type="checkbox"/>	<input type="checkbox"/>	<input type="checkbox"/>
	<input type="checkbox"/>	<input type="checkbox"/>	<input type="checkbox"/>	<input type="checkbox"/>	<input type="checkbox"/>	<input type="checkbox"/>
	<input type="checkbox"/>	<input type="checkbox"/>	<input type="checkbox"/>	<input type="checkbox"/>	<input type="checkbox"/>	<input type="checkbox"/>

Sender's e-mail must be in the e-mail list and the Enable E-mail Requests box must be checked!

NOTICE

System e-mail communications and functions are intended for informational reporting purposes only. They are intended to be used as a convenience function. E-mail communications should NOT be used as a primary means of reporting emergency information.

Receiving E-mail Status Reports

When a system status (*Alarm, Supervisory, Trouble events*) e-mail is received, the body of the e-mail contains the information entered in the “*Job Details*” section of the software (*as shown below*). If nothing is entered in the software, the body of the e-mail will only indicate the events that occurred. The events are listed after the “*Job Details*” information. They are formatted with a date/time stamp showing when the event occurred, event type, and the event description or the point information.

Figure 48. Example of Job Details in System Status E-mail

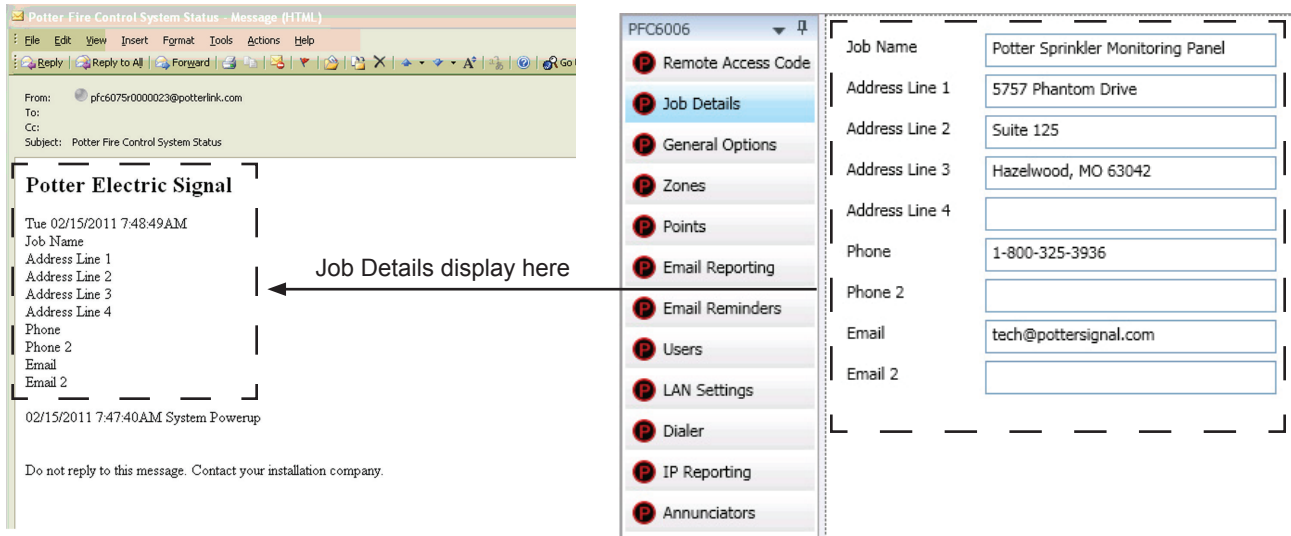

When a history status e-mail is received it contains two attachments:

- A text file (.txt)
- A comma separated values (.csv) file

Figure 49. Examples of a History text file (.txt) & History Comma Separated Value file

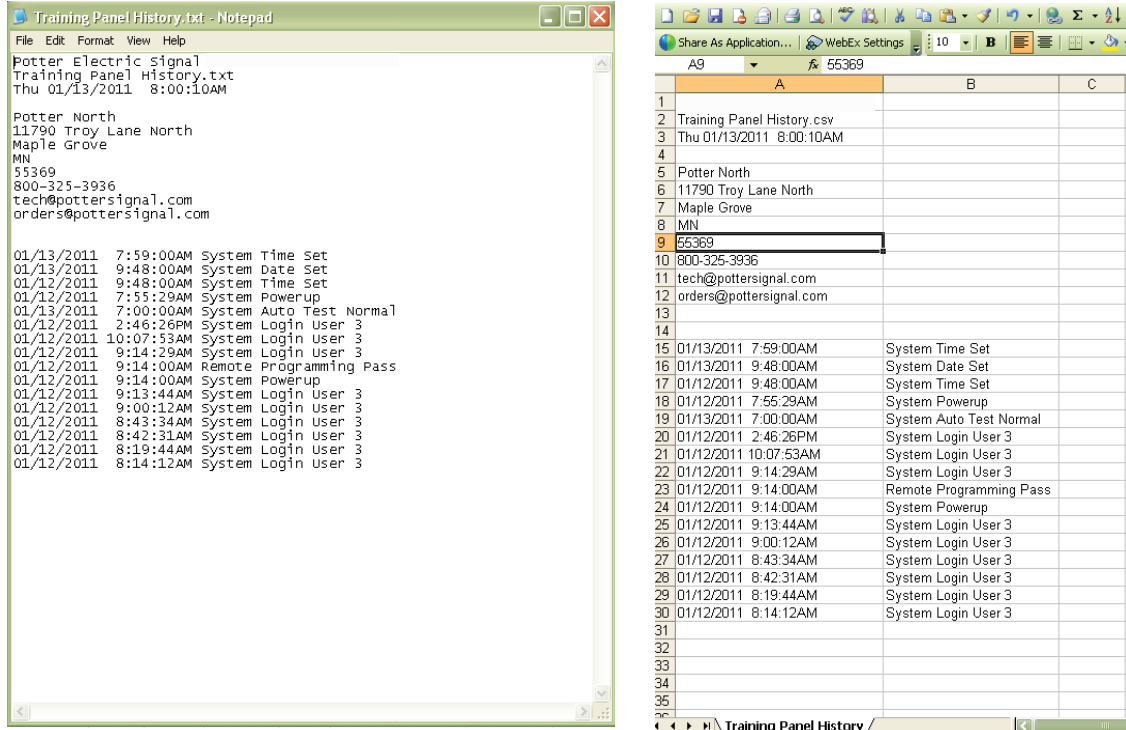

NOTICE

System e-mail communications and functions are intended for informational reporting purposes only. They are intended to be used as a convenience function. E-mail communications should NOT be used as a primary means of reporting emergency information.

Creating E-mail Reminders

E-mail reminders are fully customizable e-mail messages that may be sent based on a predefined schedule. The e-mail subject and body are defined by the installer, and they may choose to attach the *History reports*. Up to eight separate e-mail reminders can be created to be sent on a daily, weekly, monthly or yearly schedule.

Figure 50. Example of the Email Reminder Window

To create Reminder emails:

1. Select the *Email Reminders* option on the panel menu.
2. Click a Schedule option, i.e., *Yearly*, *Monthly*, *Weekly* or *Daily*.
3. Select the specific scheduling frequency, i.e., "*Days to send*" for a *Weekly* reminder or "*Time*" for a *Daily* reminder.
4. Click in "*Attach History*" selection box, if needed.
5. Complete the following information:
 - In the "*To*" field, enter up to 20 addressees.
 - In the "*Subject*" field, enter an applicable subject.
 - In the "*Body*" field, enter up to 2000 characters, if needed.

Figure 51. Example of Creating a Daily Reminder

6. Continue setting up additional "*Reminders*", if needed.

System Programming

System programming involves defining the function of points and their relationships to each other, referred to as "*mapping*". You can define behavior characteristics of individual or groups of points, map points into zones, and further customize your system using the panel configuration software from a computer.

The panel configuration software features include:

- Easy to use Windows-based editing techniques, including *drag and drop* between windows.
- Flexibility in configuring points into multiple zones promoting sophisticated mapping relationships.
- Simple sorting and grouping by select fields enhances viewing and analysis of data.
- Options to view points by type, address and function or description.

Mapping Zones Overview

Mapping is creating relationships between points, modules and sensors and their behavior between each other. Whereas, the "zone" is the framework in which you group the points. These terms and other related mapping concepts are provided in this section.

Single Zones

The *LEARN* feature creates or maps a basic, one-to-one relationship where all points are automatically grouped into **one zone**. When all points are in the same zone, and an input device is activated, all output points will activate. Please refer to the illustration below for an example of a one-to-one device relationship:

Figure 52. Mapping all Points to One Zone

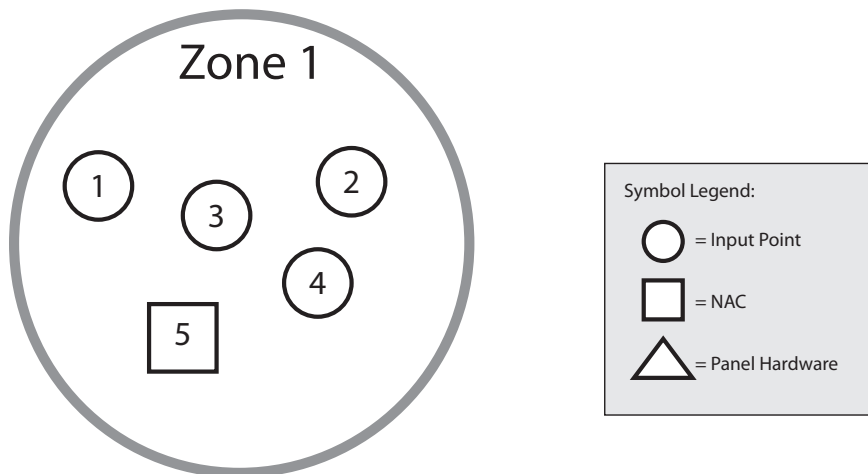

Multiple Zones

The panel configuration software allows you to customize the operational mode behavior of points by grouping them into a maximum of 30 different zones. All input points, including the one (1) on-board NAC circuit (NAC 1), may be configured to behave in a specific manner. This flexibility enables you to configure system points to maximize protection throughout your site.

By organizing points into different zones, you can create unique relationships between points for specific outputs or events. The panel configuration software allows you to efficiently group points to follow a sequence of events producing the same combination of outputs into different zones. This section addresses how to accomplish these tasks.

Mapping Terminology

The table below provides mapping terms that may be helpful to you in understanding the mapping concept:

Table 15: Mapping Terminology	
Term	Definition
Mapping	Creating relationships between points, modules and sensors and defining their behavior.
Zone	<p>A group of points.</p> <ul style="list-style-type: none"> Zones may represent a group of points located in a specific physical area at the site. Example: Zone 1 comprised of all alarm devices for a sprinkler system [<i>i.e.</i>, pull station #1, one (1) water flow device, and one (1) strobe-NAC]. Zones may represent a set of points configured for a specific function; their location may be scattered throughout the site. This group is a “logical” grouping or zone. Example: Zone 2 comprised of all points in Zone 1 as described above, plus a 2nd pull station located at end of a hallway and two (2) additional smoke detectors. <p>Notes:</p> <ol style="list-style-type: none"> If all input / output points are grouped into one (1) zone, when any input is activated, all outputs activate. A device or point may be mapped into more than one (1) zone.
Point	Any specific initiating device circuit (IDC) or appliance connected to panel.
Latching	Device will not automatically reset; device must be RESET at the keypad to remove condition.
Non-Latching	Device will automatically reset when trouble and supervisory condition is no longer present.

Zone Types / Styles

You may define or configure each zone to serve a specific purpose or to create specific output results. For procedures on how to select Zone styles, refer to the “*Configuring Zones*” section of this manual. The following zone styles are available:

Table 16: Zone Styles	
Zone	Description
Alarm	<ul style="list-style-type: none"> Default zone type. Sets system into an Alarm condition when any input is activated.
Supervisory	Used for all Supervisory inputs.
Auxiliary	Used for all “Aux” inputs.
Fire Drill	Comprised of input / output points that will activate when running a Fire Drill.
System Alarm	Used for outputs that will be activated upon any alarm.
System Supervisory	Used for outputs that will be activated upon any supervisory.
System Trouble	Used for outputs that will be activated upon any trouble.

Zone Attributes

Zone attributes are the settings that control the overall behavior of points within the zone. The zone may be configured as latching or non-latching, silenceable vs. non-silenceable, among other attributes.

Tips: Double-click in a field to modify an applicable field, i.e., zone name or alarm count. Click in fields with a selection box to select or deselect the option, i.e., silenceable or latching.

All zones default to an “Alarm” style or type when first created. The figure shown below is an example of the default attributes of a “Alarm” zone.

Figure 53. Example of Zone Attributes (Fields 1-5)

Name	Style	Silence-able	Latching	Local	Output Pattern
Zone 1	Alarm	<input checked="" type="checkbox"/>	<input checked="" type="checkbox"/>	<input type="checkbox"/>	Constant

Refer to the table below for a brief explanation of zone attributes:

Attribute	Description
<p>Zone Name Default = Zone “x” (where “x” is a sequential number)</p>	<ul style="list-style-type: none"> Zone name may be up to sixteen (16) alphanumeric characters.
<p>Latching / Non-Latching Default = Latching</p>	<ul style="list-style-type: none"> Available for one (1) count zones only. Latching zone requires operator to press Reset. Non-latching zone will automatically turn off outputs when condition clears.
<p>Local / Non-Local Default = Non-Local</p>	<ul style="list-style-type: none"> Used only for “Report by Zone” option. Allows a zone to be specified as a non-reporting zone.
<p>Output Pattern Default = Constant</p>	<ul style="list-style-type: none"> Defines the output pattern of general-purpose NAC circuit in the zone that occurs during alarm conditions. Click on drop-down arrow to display and select an option: Constant 24VDC ANSI Temp 3 .5 sec on, .5 sec off, .5 sec on, .5 sec off, 5 sec on, 1.5 sec off March Code 60 signals per minute Double Time 120 signals per minute
<p>Auto-Silence Timer Default = 0 minutes Range = 0 – 360 minutes</p>	Defines the amount of time before silenceable NAC is automatically shut down.
<p>Auto-Unsilence Timer Default = 0 minutes Range = 0 – 60 minutes</p>	Defines the amount of time before any silenced NAC is reactivated; output only reactivate if panel is still in alarm.

Table 17: Zone Attributes	
Attribute	Description
<p>Silence-Inhibit Timer <i>Default = 0 minutes</i> Range = 0 – 60 minutes</p>	Defines the amount of time you may not silence an output when in alarm.
<p>Restore Delay <i>Default = 0 seconds</i> Range = 0 – 300 seconds</p>	Defines the amount of time before deactivating an output when the panel is reset.

Creating Zones

When creating zones, you may create one or more at a time. This section explains this process and includes examples for your convenience.

To create a zone:

1. In the **Zones window**, right click on any zone name. The *shortcut menu* displays.
2. Click on “Add Zones”. The **Add Multiple Zones dialog box** displays.

Figure 54. Examples of Adding Multiple Zones Dialog Box

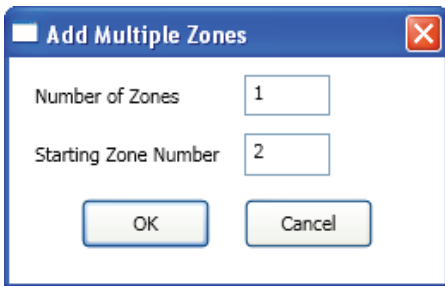

3. In “*Number of Zones*” field, enter the number of zones to create.
Note: You may enter up to **30 zones**.
4. In “*Starting Zone Number*” field, enter the zone number to begin numbering zones, if different from default.
5. Click **OK** or **Cancel** to exit dialog box. The **Zones window** lists all new zones.

Figure 55. Zones Window

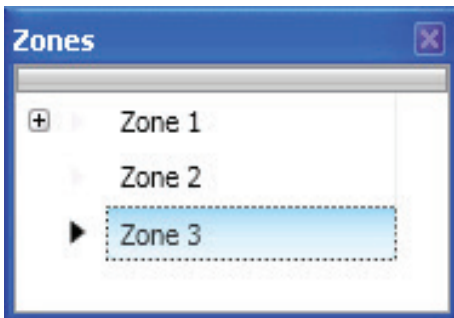

6. Go to the “**Zone Configuration**” window, to view all available zones.

Figure 56. Example of Configuring Multiple Zones

Name	Style	Silence-able	Latching	Local	Output Pattern	Auto Silence Timer	Auto Unsilence Timer	Silence Inhibit Timer
Zone 2	Alarm	<input checked="" type="checkbox"/>	<input checked="" type="checkbox"/>	<input type="checkbox"/>	Constant	0 min	0 min	0 m
Zone 3	Alarm	<input checked="" type="checkbox"/>	<input checked="" type="checkbox"/>	<input type="checkbox"/>	Constant	0 min	0 min	0 m
Zone 4	Supervisory	<input checked="" type="checkbox"/>	<input type="checkbox"/>	<input type="checkbox"/>	ANSI Temp 3	0 min	0 min	0 m

Configuring Zones

The next step is to customize a zone’s attributes, which includes changing the name, selecting type of zone, and other characteristics (i.e., *constant, double time output pattern, latching or non-latching, silenceable, auto-silence timer, etc.*).

To configure a zone:

1. Double-click in the Zone’s “**Name**” field to modify default name.

Note: Up to 16 alphanumeric characters may be entered. For example: “*Sprinkler Flow*” or “*Valve Tamper.*”

2. Click in “**Style**” field. Click the drop-down arrow to display zone styles.

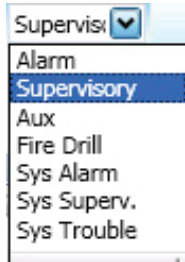

3. Choose the applicable zone style (*refer to the Zone Styles Table in this section for descriptions of zone styles*).

4. Continue editing zone’s fields. Refer to the *Zone Attributes Table* for field descriptions.

Configuring Points

This section addresses how to define or configure points through the **Points function**. Each device may have a unique function in relation to the zone as well as the entire system. The user determines the Point’s role, specific behavior characteristics, and customizes its name, if desired.

Notes:

- The list of available functions is associated to the device type.
- Points may be configured from either the **Zones** or **Points functions**; however, for purposes of this manual, points are configured in the **Points function**.
- Points can be configured individually, or by groups or ranges of points.

An example of the **Points window** is shown below.

Figure 57. Example of Points Window

Device	Addr	Name	Function	Supervisory
Built-in Pwr Sup	1	NAC	Conv NAC General Purpose	<input type="checkbox"/>
Built-in Pwr Sup	2	AUX	Conv NAC Aux Constant	<input type="checkbox"/>
Built-in Pwr Sup	3	Conv Input	Contact Input Water Flow	<input type="checkbox"/>
Built-in Pwr Sup	4	Conv Input	Conventional Smoke	<input type="checkbox"/>
Built-in Pwr Sup	5	Conv Input	Contact Input Pull Station	<input type="checkbox"/>
Built-in Pwr Sup	6	Conv Input	Contact Input Supervisory	<input checked="" type="checkbox"/>
Built-in Pwr Sup	7	Conv Input	Contact Input Tamper	<input checked="" type="checkbox"/>
Built-in Pwr Sup	8	Conv Input	Contact Input Tamper	<input checked="" type="checkbox"/>

Input Circuit Functions

The IDC's ("*Conventional Inputs*") default to specific functions as shown in the 2nd table below; however, they may be reconfigured and renamed, based on the following configuration functions:

Table 18: Input Circuit Functions	
Function	Description
Contact Input Pull Station	Pull Station Input
Contact Input Water Flow	Water Flow Input obeys water flow delay as defined in " General Options ".
Contact Input Supervisory	Supervisory Input
Contact Input Tamper	Tamper Input reports as supervisory.
Contact Input Fire Drill	Fire Drill Input activates a fire drill.
Contact Input Trouble Monitor	Trouble Input creates a trouble condition.
Contact Input Aux	Aux Input reports as un-typed alarm.

The six (6) Input or Initiating Device Circuits (IDC) automatically default as follows:

Table 19: Input Circuit's Default Configuration	
Input Circuit	Default Function
Input 1	Water Flow
Input 2	Smoke Detector
Input 3	Manual Pull
Inputs 4 & 5	Supervisory
Input 6	Valve Tamper

NAC Functions

The on-board **NAC circuit** (NAC 1) is automatically configured as “*Conv NAC General Purpose*”, but may be reconfigured to other functions, as described in the table below:

Table 20: NAC Circuit Configuration Functions	
Function	Description
General Purpose	General purpose NAC; obeys zone “ <i>output pattern</i> ” programming, and is the default.
Potter Sync	Drives Potter synchronized horns / strobes.
Gentex Sync	Drives Gentex synchronized horns / strobes.
System Sensor Sync	Drives System Sensor synchronized horns / strobes.
Wheelock Sync	Drives Wheelock synchronized horns / strobes.

AUX Functions

The on-board **AUX circuit** automatically is configured as “*Conv NAC Aux Constant*”. Other configuration options are available, as described in the table below:

Table 21: AUX Circuit Configuration Functions	
Function	Description
Conv NAC Aux Constant	Constant DC power; this is the default.
Conv NAC Aux Resettable	Constant DC power; disconnects power during system reset.
Conv NAC Aux Door Holder	Constant DC power; disconnects when an alarm occurs.
Conv NAC Aux Door Holder Low AC Drop	Constant DC power; disconnects on AC Loss or when an alarm occurs.

To configure a single point:

1. Click on the **Points function** to display the "*Points Configuration*" window.

Figure 58. Example of a Configuration Window Showing Conventional Input Functions

Device	Addr	Name	Function	Supervisory
Built-in Pwr Sup	1	NAC	Conv NAC General Purpose	<input type="checkbox"/>
Built-in Pwr Sup	2	AUX	Conv NAC Aux Constant	<input type="checkbox"/>
Built-in Pwr Sup	3	Conv Input	Contact Input Water Flow	<input type="checkbox"/>
Built-in Pwr Sup	4	Conv Input	Conventional Smoke	<input type="checkbox"/>
Built-in Pwr Sup	5	Conv Input	Contact Input Pull Station	<input type="checkbox"/>
Built-in Pwr Sup	6	Conv Input	Contact Input Supervisory	<input type="checkbox"/>
Built-in Pwr Sup	7	Conv Input	Contact Input Tamper	<input type="checkbox"/>
Built-in Pwr Sup	8	Conv Input	Contact Input Tamper	<input type="checkbox"/>

Time	Medium	URI/Phone	Filename
01/04/2012 11:05	IP	10.0.5.11	C:\Documents and

- Unused
- Contact Input Pull Station
- Contact Input Water Flow
- Contact Input Supervisory
- Contact Input Tamper**
- Contact Input Fire Drill
- Contact Input Trouble Monitor
- Contact Input Aux
- Contact Input CO Alarm
- Contact Input CO Supervisory
- Conventional Smoke
- Conventional Heat

Notes:

- Points are listed by device addresses automatically. You may sort points by clicking on the column or field name, i.e., "*Name*", "*Function*", or "*Supervisory*".

Example: Click on the "*Function*" field to sort points alphabetically by device function.

- The list of available functions varies according to type of device(s) selected.
- If you click the "*Supervisory*" field selection box, this designates that the contact will be a supervisory input versus an alarm input.

2. Click anywhere are the point you wish to configure.

TIP: The selected point is highlighted in blue and also designated with an arrow symbol at the beginning of the point's line, as shown below.



3. Double-click in "**Name**" field to enter a descriptive name, if wanted.

- Enter up to 16 alphanumeric characters.

4. Click on drop-down arrow at the end of the "*Function*" field to display list of options.

Figure 59. Example of Configuring a "Single" Point

▶ Built-in Pwr Sup	3	Conv Input	Contact Input Water Flow
▶ Built-in Pwr Sup	4	Conv Input	Unused
▶ Built-in Pwr Sup	5	Conv Input	Contact Input Pull Station
▶ Built-in Pwr Sup	6	Conv Input	Contact Input Water Flow
▶ Built-in Pwr Sup	7	Conv Input	Contact Input Supervisory
▶ Built-in Pwr Sup	8	Conv Input	Contact Input Tamper
▶ Built-in Pwr Sup			Contact Input Fire Drill
▶ Built-in Pwr Sup			Contact Input Trouble Monitor
▶ Built-in Pwr Sup			Contact Input Aux
▶ Built-in Pwr Sup			Contact Input CO Alarm
▶ Built-in Pwr Sup			Contact Input CO Supervisory
▶ Built-in Pwr Sup			Conventional Smoke
▶ Built-in Pwr Sup			Conventional Heat

5. Continue configuring other points, as needed.

To configure a range of points:

1. Click the first point to configure from the “**Function**” field.
2. Press and hold the **SHIFT** key, then click in “**Function**” field of last point.

Figure 60. Example of Configuring a “Range” of Points

Device	Addr	Name	Function
Built-in Pwr Sup	1	NAC	Conv NAC General Purpose
Built-in Pwr Sup	2	AUX	Conv NAC Aux Constant
Built-in Pwr Sup	3	Conv Input	Contact Input Water Flow
Built-in Pwr Sup	4	Conv Input	Contact Input Tamper
Built-in Pwr Sup	5	Conv Input	Contact Input Tamper
Built-in Pwr Sup	6	Conv Input	Contact Input Tamper
Built-in Pwr Sup	7	Conv Input	Contact Input Tamper
Built-in Pwr Sup	8	Conv Input	Contact Input Tamper

3. Right-click from “**Function**” field to display configuration options.

Notes:

- If you right-click outside of “**Function**” field, the range is deselected, and only one (1) point will be configured.
- You may alternatively use the **CTRL** key to select multiple, non-adjacent points.

4. Click on device function from shortcut menu.
5. Continue configuring other points, as needed.

Adding Points to Zones

This section provides procedures and examples of adding points to one or more zones. Points can be moved and deleted from zones through the Zones panel using the “drag and drop” technique. The examples illustrate how to use shortcuts to expedite configuring zones and also to reinforce the interaction between the Zones and Points windows.

To move one or more points into one zone:

1. Open the Zones’ configuration window and adjust Points’ window to display full function name(s).

Figure 61. Example of Resizing Points Window From Zone Screen

Name	Style	Silenceable	Latching	Local	Output Pattern	Silence Timer	Unsilence Timer
Zone 2	Supervisory	<input checked="" type="checkbox"/>	<input checked="" type="checkbox"/>	<input type="checkbox"/>	Constant	0 min	0 min
Zone 3	Alarm	<input checked="" type="checkbox"/>	<input checked="" type="checkbox"/>	<input type="checkbox"/>	Constant	0 min	0 min

Addr	Name	Function
1	NAC	Conv NAC General Purpose
2	AUX	Conv NAC Aux Constant
3	Conv Input 1	Contact Input Water Flow
4	Conv Input 2	Contact Input Tamper
5	Conv Input 3	Contact Input Tamper
6	Conv Input 4	Contact Input Tamper
7	Conv Input 5	Contact Input Tamper
8	Conv Input 6	Contact Input Tamper

2. Click on one or more points to select; use the **SHIFT** or **CTRL** keys to select a range or group of points.

3. Drag and drop selected points from the *Points' window* to the “*Device*” *window*. The selected points display in the “*Device*” *window*, as shown below.

Figure 62. Example of Configuring Multiple Points into Multiple Zones

Points 4, 6 & 7 are configured into Zones 2 and 3.

Name	Style	Silence-able	Latching	Local	Output Pattern	Silence Timer	Unsilence Timer	Hide Unused Points
Zone 2	Supervisory	<input checked="" type="checkbox"/>	<input checked="" type="checkbox"/>	<input type="checkbox"/>	Constant	0 min	0 min	
Zone 3	Alarm	<input checked="" type="checkbox"/>	<input checked="" type="checkbox"/>	<input type="checkbox"/>	Constant	0 min	0 min	

Addr	Name	Function
1	NAC	Conv NAC General Purpose
2	AUX	Conv NAC Aux Constant
3	Conv Input 1	Contact Input Water Flow
4	Conv Input 2	Contact Input Tamper
5	Conv Input 3	Contact Input Tamper
6	Conv Input 4	Contact Input Tamper
7	Conv Input 5	Contact Input Tamper
8	Conv Input 6	Contact Input Tamper

Device	Addr	Name	Function	Supervisory
Built-in Pwr Sup	1	NAC	Conv NAC General Purpose	<input type="checkbox"/>
Built-in Pwr Sup	2	AUX	Conv NAC Aux Constant	<input type="checkbox"/>
Built-in Pwr Sup	4	Conv Input	Contact Input Tamper	<input checked="" type="checkbox"/>
Built-in Pwr Sup	5	Conv Input	Contact Input Tamper	<input checked="" type="checkbox"/>
Built-in Pwr Sup	6	Conv Input	Contact Input Tamper	<input checked="" type="checkbox"/>
Built-in Pwr Sup	7	Conv Input	Contact Input Tamper	<input checked="" type="checkbox"/>

4. Click “+” in *Points window* to display point assignment by Zone(s).

Figure 63. Example of Expanding Point’s Zone Assignment(s)

Loop	Addr	Name	Function
⊕ Built-in Pwr Sup	1	NAC	Conv N
⊕ Built-in Pwr Sup	2	AUX	Conv N
⊕ Built-in Pwr Sup	3	Conv Input 1	Contact
⊖ Built-in Pwr Sup	4	Conv Input 2	Contact
▶ Zone 2			
▶ Zone 3			
⊕ Built-in Pwr Sup	5	Conv Input 3	Contact
⊕ Built-in Pwr Sup	6	Conv Input 4	Contact
⊖ Built-in Pwr Sup	7	Conv Input 5	Contact
▶ Zone 5			
▶ Zone 2			
▶ Zone 3			
⊖ Built-in Pwr Sup	8	Conv Input 6	Contact
▶ Zone 6			

Note: Click “-” to collapse point assignments.

Group by Area

You may group information by different fields in many of the program windows. This flexibility is helpful when configuring or viewing a large amount of information, such as all points, zones or remote annunciators. Examples are included for illustration purposes only.

To group by area (field):

1. Click on “*group bar*” located at top of window, if available.

Figure 64. Example of Points Window

Device	Addr	Name	Function	Supervisory
Built-in Pwr Sup	1	NAC	Conv NAC General Purpose	<input type="checkbox"/>
Built-in Pwr Sup	2	AUX	Conv NAC Aux Constant	<input type="checkbox"/>
Built-in Pwr Sup	3	Conv Input	Contact Input Water Flow	<input type="checkbox"/>
Built-in Pwr Sup	4	Conv Input	Conventional Smoke	<input checked="" type="checkbox"/>
Built-in Pwr Sup	5	Conv Input	Contact Input Tamper	<input checked="" type="checkbox"/>
Built-in Pwr Sup	6	Conv Input	Conventional Smoke	<input checked="" type="checkbox"/>
Built-in Pwr Sup	7	Conv Input	Conventional Smoke	<input checked="" type="checkbox"/>
Built-in Pwr Sup	8	Conv Input	Conventional Heat	<input checked="" type="checkbox"/>

2. The “*group by area*” prompt displays, as shown.

Figure 65. Group by Area Prompt

Device	Addr	Name	Function	Supervisory
Built-in Pwr Sup	1	NAC	Conv NAC General Purpose	<input type="checkbox"/>
Built-in Pwr Sup	2	AUX	Conv NAC Aux Constant	<input type="checkbox"/>
Built-in Pwr Sup	3	Conv Input	Contact Input Water Flow	<input type="checkbox"/>
Built-in Pwr Sup	4	Conv Input	Conventional Smoke	<input checked="" type="checkbox"/>
Built-in Pwr Sup	5	Conv Input	Contact Input Tamper	<input checked="" type="checkbox"/>
Built-in Pwr Sup	6	Conv Input	Conventional Smoke	<input checked="" type="checkbox"/>
Built-in Pwr Sup	7	Conv Input	Conventional Smoke	<input checked="" type="checkbox"/>
Built-in Pwr Sup	8	Conv Input	Conventional Heat	<input checked="" type="checkbox"/>

Note: Click on “*group by area*” bar at any time to collapse region.

3. Drag and drop **one field** into the “*group by area*” region. The information displays grouped by selected field.

Figure 66. Example of Points Grouped by Function

Function	Count
Contact Input Tamper	1 item
Contact Input Water Flow	1 item
Conv NAC Aux Constant	1 item
Conv NAC General Purpose	1 item
Conventional Heat	1 item
Conventional Smoke	3 items

- Click “+” next to the function to view a complete list of points. Click “-” to collapse list of points, as needed.

Figure 67. Example of Expanded List of Grouped Points

Hide Unused Points

Function ▾

+ Contact Input Tamper (1 item)

+ Contact Input Water Flow (1 item)

+ Conv NAC Aux Constant (1 item)

- Conv NAC General Purpose (1 item)

Device	Addr	Name	Function	Supervisory
Built-in Pwr Sup	1	NAC	Conv NAC General Purpose	<input type="checkbox"/>

+ Conventional Heat (1 item)

- Conventional Smoke (3 items)

Device	Addr	Name	Function	Supervisory
Built-in Pwr Sup	4	Conv Input	Conventional Smoke	<input checked="" type="checkbox"/>
Built-in Pwr Sup	6	Conv Input	Conventional Smoke	<input checked="" type="checkbox"/>
Built-in Pwr Sup	7	Conv Input	Conventional Smoke	<input checked="" type="checkbox"/>

Note: Click “-” to collapse point assignments.

- Drag the field out of “*group by area*” region to redisplay items in original order.

Programming Points & Appliances

This section addresses how to program the P-Link appliances and points, including the on-board DACT, and the RA-6075 annunciator.

On-Board DACT

Each system has a built-in DACT or Digital Alarm Communicator Transmitter. The DACT provides notification to a remote monitoring company when alarms, troubles and supervisory conditions occur.

Programming options allow you to select separate accounts for test events and alarm, trouble, and supervisory conditions. You may set up telephone parameters, such as number of rings, when and where to send reports by specifying phone numbers and other report output options. An example of the *Add – Dialer window* is shown.

Figure 68. Example of DACT Add-Dialer Window

The screenshot shows the 'Add Dialer' window with two sections for 'Phone Line 1' and 'Phone Line 2'. Each section has checkboxes for 'Enabled', 'Answering Machine Bypass', 'Enable Line Monitor', and 'Disable Dial Tone Detection'. Below these are input fields for 'Number Of Rings' (set to 0) and 'Line Prefix'. A callout box with arrows pointing to the 'Number Of Rings' and 'Line Prefix' fields contains the text: 'These fields are important! Be sure to modify # of rings and line prefix fields according to your site's telephone setup! Refer to procedures on next page.'

Below the dialer configuration is a 'Reporting Accounts' table with the following columns: Report Alarms, Report Troubles, Report Supervisory, Primary Account ID, Primary Phone Number, Primary Report By, Primary Format, Primary Report Test Events, Secondary Account ID, Secondary Phone Number, Secondary Report By, Secondary Format, and Secondary Report Test Events. The table contains five rows of data, each with a right-pointing arrow in the first column and checkboxes in the other columns.

Notes:

1. A daily test is automatically sent to a remote monitoring location; the test time may be programmed through the *General Options program window – “Time to Send Autotest” field*.
2. Once the panel has been programmed to use a dialer, and two (2) phone lines are used, the DACT will alternate between lines on each daily call.
3. If the IP Communicator is programmed, the daily test call can be sent to the both reporting accounts. (*Please refer to the IP Communicator Section for more information.*)
4. If the DACT and the IP Communicator are not programmed, the system will operate as a local panel.

Reporting Accounts

The “*Reporting Accounts*” section is used to program DACT operations and to customize the format of the reporting accounts. You may choose different settings for Alarms, Troubles, and Supervisory conditions. Up to five (5) primary and secondary reporting accounts may be configured.

Figure 69. Example of Dialer Reporting Options

Reporting Accounts

Report Alarms	Report Troubles	Report Supervisory	Primary Account ID	Primary Phone Number	Primary Report By	Primary Format	Primary Report Test Events	Secondary Account ID	Secondary Phone Number	Secondary Report By	Secondary Format	Secondary Report Test Events
▶	<input type="checkbox"/>	<input type="checkbox"/>			Panel	CID	<input type="checkbox"/>			Panel	CID	<input type="checkbox"/>
▶	<input type="checkbox"/>	<input type="checkbox"/>			Panel	CID	<input type="checkbox"/>			Panel	CID	<input type="checkbox"/>
▶	<input type="checkbox"/>	<input type="checkbox"/>			Panel	CID	<input type="checkbox"/>			Panel	CID	<input type="checkbox"/>
▶	<input type="checkbox"/>	<input type="checkbox"/>			Panel	CID	<input type="checkbox"/>			Panel	CID	<input type="checkbox"/>
▶	<input type="checkbox"/>	<input type="checkbox"/>			Panel	CID	<input type="checkbox"/>			Panel	CID	<input type="checkbox"/>

Remote Annunciators

The PFC-6006 supports up to four (4) RA-6075 remote annunciators.

To add and configure a remote annunciator:

1. Select **Annunciators** from system panel.
2. Click the **Add Device** button to display the "Add Device" window.

Figure 70. Example of the Add Annunciator Device Window

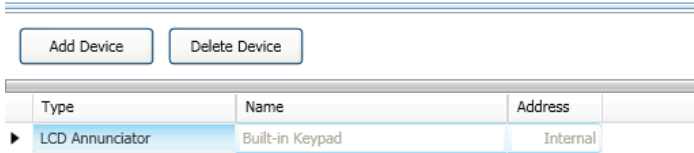

3. Double-click in the "**Name**" *field* to customize name.
4. Double-click in "**Address**" *field* to adjust address, if needed.
5. Repeat steps, as needed, to continue adding annunciators.

Section 6: IP Communication

The system's built-in, on-board IP Communicator provides notification to a remote monitoring company when alarms, troubles, and supervisory conditions occur. The IP Communicator is used with an IP capable Sur-Guard receiver by means of the Fibro protocol.

Programming options allow you to select accounts for test events and alarm, trouble, and supervisory conditions. You may set up IP parameters, such as when and where to send reports by specifying IP addresses and other report output options. An example of the *Add – IP Communicator window* is shown below.

Figure 71. Example of the IP Reporting Window

The screenshot shows the 'Add IP Reporting' window. At the top, there are two buttons: 'Add IP Reporting' and 'Delete IP Reporting'. Below these is a 'Reporting Method Priority' section with two radio buttons: 'Primary' (selected) and 'Secondary'. Underneath is a 'Panel UDP Port' field with the value '3060'. The main section is titled 'IP Reporting Accounts' and contains a table with the following columns: 'Report Alarms', 'Report Troubles', 'Report Supervisory', 'Report By', 'Primary Account Settings', and 'Secondary Account Settings'. The table has five rows, each representing an account. The first row is highlighted with a dashed blue border. The fourth row is highlighted with a solid blue border and has a dropdown arrow next to the 'Report By' field.

	Report Alarms	Report Troubles	Report Supervisory	Report By	Primary Account Settings	Secondary Account Settings
▶	<input type="checkbox"/>	<input type="checkbox"/>	<input type="checkbox"/>	Point	> ...	> ...
▶	<input type="checkbox"/>	<input type="checkbox"/>	<input type="checkbox"/>	Point	> ...	> ...
▶	<input type="checkbox"/>	<input type="checkbox"/>	<input type="checkbox"/>	Point	> ...	> ...
▶	<input type="checkbox"/>	<input type="checkbox"/>	<input type="checkbox"/>	Point ▼	> ...	> ...
▶	<input type="checkbox"/>	<input type="checkbox"/>	<input type="checkbox"/>	Point	> ...	> ...

Notes:

1. A daily test can automatically be sent to a remote monitoring location; the test time may be programmed through the *General Options program window – “Time to Send Autotest” field*.
2. If the system has been programmed to use the IP Communicator and the on-board DACT, the daily test call can be sent to both reporting accounts.
3. If the IP Communicator is not programmed and the on-board DACT is not enabled, the system will operate as a local panel.
4. Where the fire alarm transmitter is sharing on-premises communications equipment, the shared equipment shall be UL listed.
5. Secondary power shall be provided for all equipment necessary for the transmission and reception of alarm, supervisory and trouble signals at the protected premises.
6. Secondary power shall be provided for all equipment necessary for the transmission and reception of alarm, supervisory and trouble signals at the supervising station.

IP Reporting Accounts

The "*IP Reporting Accounts*" section is used to program the IP Communicator operations and to customize the format of the reporting accounts. You may choose different settings for Alarms, Troubles and Supervisory conditions. Up to five (5) primary or secondary accounts may be configured.

To add and configure a IP Dialer:

1. Select **IP Dialer** from the system panel, and click the **Add IP Reporting button**.

The "*IP Reporting*" window displays.

Figure 72. Example of the IP Reporting Window

Report Alarms	Report Troubles	Report Supervisory	Report By	Primary Account Settings	Secondary Account Settings
<input type="checkbox"/>	<input type="checkbox"/>	<input type="checkbox"/>	Point	> ...	> ...
<input type="checkbox"/>	<input type="checkbox"/>	<input type="checkbox"/>	Point	> ...	> ...
<input type="checkbox"/>	<input type="checkbox"/>	<input type="checkbox"/>	Point	> ...	> ...
<input type="checkbox"/>	<input type="checkbox"/>	<input type="checkbox"/>	Point	> ...	> ...
<input type="checkbox"/>	<input type="checkbox"/>	<input type="checkbox"/>	Point	> ...	> ...

2. In the **Reporting Method Priority** field select the applicable priority.











- **Primary** – IP Reporting account is used as the first path of communication to the remote monitoring station.
 - **Secondary** – IP Reporting account is used as the alternate path of communication to the remote monitoring station.
3. In the **Panel UDP Port field**, click to enter an ingoing and outgoing UDP Port. The **UDP** or **User Data Protocol** is the pathway for which data is sent and received between the panel and the remote monitoring station.

Note: The default UDP Port is 3060; however, an alternate port number may be used. Check with your Network Administrator to determine if an alternate port number for FACP IP Reporting should be assigned.

4. In the "*IP Reporting Accounts*" section, make the necessary selections for the primary and secondary reporting accounts:
 - Select the **Report type(s)**: *Alarms, Troubles, Supervisory*
 - Click on the **Report By**  **drop-down arrow** to choose an option: *Panel, Zone or Point*



- Click on the **Primary / Secondary Account Settings**  to display additional setup options, as shown below:

Figure 73. Example of Primary Account Settings "Expanded" Window

Report Alarms	Report Troubles	Report Supervisory	Report By	Primary Account Settings	Primary Account ID	Primary Format	Primary Report Test Events	Primary Receiver IP	Primary Protocol	Primary UDP Port	Supervision Interval (sec)	Primary Encryption Key	Primary Encryption Method	Primary Receiver Number	Primary Account Prefix	Secondary Account Settings
<input type="checkbox"/>	<input type="checkbox"/>	<input type="checkbox"/>	Point			SIA	<input type="checkbox"/>	0.0.0.0	SIA-DC09	0	20		None			
<input type="checkbox"/>	<input type="checkbox"/>	<input type="checkbox"/>	Point			SIA	<input type="checkbox"/>	0.0.0.0	SIA-DC09	0	20		None			
<input type="checkbox"/>	<input type="checkbox"/>	<input type="checkbox"/>	Point			SIA	<input type="checkbox"/>	0.0.0.0	SIA-DC09	0	20		None			
<input type="checkbox"/>	<input type="checkbox"/>	<input type="checkbox"/>	Point			SIA	<input type="checkbox"/>	0.0.0.0	SIA-DC09	0	20		None			
<input type="checkbox"/>	<input type="checkbox"/>	<input type="checkbox"/>	Point			SIA	<input type="checkbox"/>	0.0.0.0	SIA-DC09	0	20		None			

Notes:

- Use the **scroll bar** to display additional fields if not shown on right.
- Click the  **collapse icon** at any time to hide the account setting fields.

- Enter the **Account ID**.
- Select the applicable **Primary Format option: CID / SIA**
- Click in the **Report Test Events selection box**  to send *Test* signals to this account.
- Double-click in the **Receiver IP field** and enter the IP address provided by the remote monitoring station.
- Click on the **Protocol**  to select *Fibro*.

Note: Fibro communications is used with the Sur-Guard receiver.

- Double-click in the **UDP port field** to enter the *Primary/Secondary port number* as provided by the remote monitoring station.

Note: The UDP port number is the pathway for data which the receiver receives from the system panel and sends to the system panel.

- Double-click in the **Supervision Interval field** to adjust the amount of time (*in seconds*) that the panel's IP Communicator will send a supervision signal to the remote monitoring receiver.
 - Default setting is 20 seconds.
 - Contact the remote monitoring station to verify the correct setting. The receiver is programmed with a specific window of time to "see" the supervision signal. If the supervision signal is not seen within the programmed time, the receiver generates a *Trouble signal* after six (6) failed communication attempts.
- Double-click in **Encryption Key** to enter an applicable number as provided by the remote monitoring station.
- Click on the **Encryption Method**  to select 128 bit, if applicable.

Note: If the Encryption Method is set to "None", then an Encryption Key is not needed.

- Click on the  **collapse icon** to hide the account setting field when finished.







Reminder: Click the  **expand ellipsis icon** to review or modify the account settings at any time.

- Repeat steps for each Primary / Secondary reporting account or to edit an account.

Section 7: Appendices

Appendix A – Basic Operating Instructions

These instructions must be framed and displayed next to the PFC-6006 panel in accordance with NFPA 72 fire code for Local Protected Fire Alarm Systems. Test the system in accordance to NFPA 72.

Button	Function
ACKNOWLEDGE	
ARROW KEYS	
FIRE DRILL	
ESC	
RESET	
SIGNAL SILENCE	

Operation	Task
Silence Alarms, Troubles	Press the SIGNAL SILENCE pushbutton.
Acknowledge Alarms, Troubles	Press the ACKNOWLEDGE pushbutton after scrolling down to new event.
Reset Alarms	Press the RESET pushbutton.
View Alarms, Troubles	Press ARROW(S) to view alarms / troubles.
Conduct a Fire Drill	Press the FIRE DRILL pushbutton; press the RESET button to exit Drill mode.
View Point's Status	<ul style="list-style-type: none"> • Press ENTER to display the Main Menu. • Press 5 – System Tools; enter panel's code. • Press 1 – Point Control. • Press ENTER to select Point. • Enter Addr / Ckt No. and press ENTER. • Press Up/Down to view previous / next points.
Alarm Signal Activation	<ul style="list-style-type: none"> • Press the LEFT and Right Arrow Keys at the same time.

Table 23: Operating Instructions

Operation	Task
Set Date / Time	<ul style="list-style-type: none"> • Press ENTER – Main Menu. • Press 3 – Set Date / Time. • Use keypad to enter correct date; use right arrow to move through date field and to display time field. • Press ENTER to save changes.
Enable / Disable Point	<ul style="list-style-type: none"> • Press ENTER – Main Menu. • Press 2 – Enable/Disable; enter panel’s code. • Press 1 – By Point • Enter Addr / Ckt No. and press ENTER. • Press Up / Down to scroll. • Point’s current status displays “<i>Normal</i>” if enabled, or “<i>Disabled</i>”. • Press ENTER to <i>change status</i>; press ENTER to save or ESC to exit without saving.
View Event History	<ul style="list-style-type: none"> • Press ENTER – Main Menu. • Press 1 – View History. • Press Left / Right to view next / previous events. • Press Up / Down for list of events. • Press ESC to exit.
Service Call:	

Appendix B – Modem Connectivity Setup

If your computer uses a modem for connectivity to the panel, choose the **Options – Communications menu option**. Next, select “*Modem*” as the transfer medium, and specify the *modem com port*. In rare instances, a modem may also require an initialization string. Refer to your manufacturer’s instructions for this information.

To setup a modem:

1. Select **Options – Communication**. The “*Communication – Options*” dialog box displays.

Figure 74. Example of Modem Communication Setup

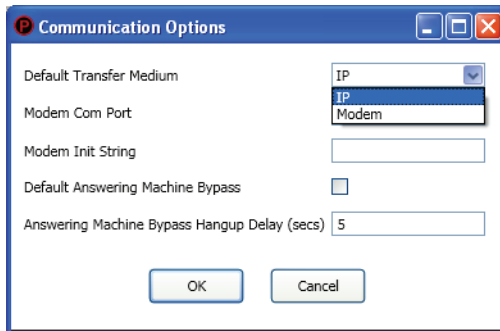

2. Click in “*Default Transfer Medium*” field and select “*modem*”.
3. Click in “*Modem Com Port*” field to select the applicable com port. If required, enter the initialization string.

Figure 75. Example of Com Port Modem Setup

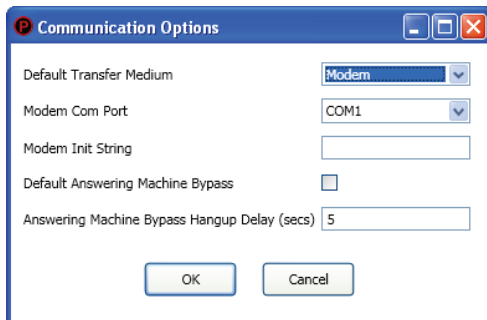

4. Click **OK** to save changes.

Appendix C – System Maintenance and Testing

Acceptance Test

The control panel is required to be installed in accordance with local and state building codes and NFPA 72 (*National Fire Alarm Code*). At the conclusion of each original installation or modification of this system, the control panel and related system is required to be inspected and tested in accordance with NFPA 72 to verify compliance with the applicable standards.

Testing should be conducted by Potter factory trained fire alarm technician(s) in the presence of a representative of the Authority Having Jurisdiction (AHJ) and the building owners representative. Refer to NFPA 72 (*National Fire Alarm Code*), Inspection Testing and Maintenance.

Periodic Testing and Service

Periodic testing and maintenance of the control panel, all initiating points, all notification appliances and any other associated equipment is essential to ensure the system will operate as designed in emergency situations. Service and test the control panel according to the schedules and procedures outlined in the following documents:

- NFPA 72, Inspection, Testing and Maintenance.
- Service manuals and instructions for any and all peripheral points installed in the system. It is very important that any and all trouble conditions (or faults) be corrected immediately.

Operational Checks

During interim periods between formal testing and at regular intervals the control system should be subjected to the following operational performance checks. The Authority Having Jurisdiction (AHJ) should be consulted for requirements on frequency of system testing.

- Check that the green AC power LED is lit.
- Check that all amber LED's are off.
- Using the system menus, perform a Lamp Test function. Verify that all LED's and LCD segments operate.
- Before proceeding: (1) Notify the fire department and the central alarm receiving station if transmitting alarm status conditions; (2) Notify facility personnel of the test so that alarm-indicating points are disregarded during the test period; and (3) When necessary, bypass activation of alarm notification appliances and speakers (if installed) to prevent sounding of evacuation signals.
- Activate an input device (*i.e., manual station, heat or smoke detector*), and check that all notification appliances function.
- Notify Fire Department, central alarm receiving station and /or building personnel when finished with testing the system.
- The test of ground fault must be measured in below 10k ohms impedance.

AC Fuse

The control panel has one fuse on the board for the AC power over current protection. The AC fuse is rated at 1.6A-250VAC Time-Lag and screened onto the main board as F2.

Battery Fuse

The battery fuse is rated at 2.5A-250VAC Time-Lag and screened onto the main board as F1.

Battery Maintenance

The system has been designed to use maintenance-free sealed lead acid batteries. These sealed lead acid batteries do not require any additional water or electrolyte. The system will keep all batteries fully charged by the system's power supply modules float charger. A typical discharged battery will recharge at 0.5A and reaches the voltage of 27.3 VDC within 48 hours. The battery is to remain in the cabinet with nothing on or around the batteries.

Replacement and Testing Recommendations

The batteries are to be replaced at least once every four years or more frequently if specified by local AHJ and manufacturer recommendations. Batteries should be dated at the installation. Minimal replacement battery capacity displays on the control panel marking label. The batteries are required to be UL Recognized batteries with a date of manufacture permanently marked on the battery. The battery is to be tested at least annually and if the battery is showing signs of failure, it should be replaced. Immediately replace a damaged or leaking battery, and always replace batteries in pairs.

Proper Handling / First Aid Procedures

- In the event a battery leaks and contact is made with the Sulfuric Acid, immediately wash skin with water for at least 15 minutes. Water and household baking soda provides a good neutralizing solution for Sulfuric Acid.
- If Sulfuric Acid makes contact with eyes, flush with water for 15 minutes and seek immediate medical attention.
- Ensure proper handling of the battery to prevent short-circuits.
- Take care to avoid accidental shorting of the leads from uninsulated work surfaces, tools, jewelry and coins.
- If a battery is shorted, the battery and any connected equipment may be damaged. Additionally, a short may injure personnel.

Appendix D – Compatible Points Table

This section provides a listing of all NAC appliances, two-wire (2-wire) smoke detectors, the built-in DACT and remote annunciator device compatibilities.

Table 24: Device Compatibilities	
Module/Device	Compatibilities
NAC Appliances	Refer to Potter document “5403592 NAC Compatibility Document”.
Two-Wire (2-Wire) Smoke Detectors	Refer to Appendix E for a complete listing of 2-wire smoke detectors.
On Board DACT	DACT – The on-board DACT transmits in Ademco Contact ID and Security Industries Association’s Digital Communication Standards (SIA-DCS). Each account may be configured for Contact ID or SIA-DCS independent of the other account’s setting. Therefore, some account(s) could be Contact ID and others could be SIA-DCS or vice versa. Similarly, accounts could be the same reporting type.
Receivers	Silent Knight Model 9500/9800 (Ademco MX8000) Sur-Gard System III – SG-DRL3 (POTS Line Card)
IP Reporting	Sur-Gard System III – SG-DRL3-IPCA (Network Line Card) Notes: <ol style="list-style-type: none"> 1. Where the fire alarm transmitter is sharing on-premises communications equipment, the shared equipment shall be Listed. 2. Secondary power shall be provided for all equipment necessary for the transmission and reception of alarm, supervisory and trouble signals at the protected premises. 3. Secondary power shall be provided for all equipment necessary for the transmission and reception of alarm, supervisory and trouble signals at the supervising stations. 4. The connection between the FACP and on-premises communications equipment shall be limited to 20 feet and enclosed in conduit or equivalently protected against mechanical injury.
RS-485 Points	RA-6075 – LCD Remote Annunciator

Appendix E – Compatible Smoke Detectors Table

Table 25: Smoke Detector Compatibilities			
Detector Model	Identifier	Base Model	Identifier
SYSTEM SENSOR (Brk) (Max. No. Of Detectors Per Zone Is 20)			
1400*	A	N/A	N/A
2400*	A	N/A	N/A
2400TH*	A	N/A	N/A
2W-B	A	N/A	N/A
2WT-B	A	N/A	N/A
DETECTION SYSTEM (Max. No. Of Detectors Per Zone Is 25)			
DS250	A	MB2W/MB2WL	A
DS250TH	A	MB2W/MB2WL	A
ESL (Max. No. Of Detectors Per Zone Is 25)			
611U	S10	601U	S00
611UD	S10	601U	S00
611UT	S10	601U	S00
612U	S10	601U	S00
612UD	S10	601U	S00
613U5	S10	601U	S00
611UD	S10	609U10	S00
612UD	S10	609U10	S00
425C	S10	N/A	N/A
425CT	S10	N/A	N/A
HOCHIKI (Max. No. Of Detectors Per Zone Is 25)			
SLR-24*	HD-3	HSC-221R	HB-71
		HSB-221	HB-54
		HSB-221N	HB-54
		NS6-221	
		NS4-221	
		NS6-220	HB-3
SLR-24H*	HD-3	HSC-221R	HB-71
		HSB-221	HB-54
		HSB-221N	HB-54
		NS6-221	
		NS4-221	
SIJ-24*	HD-3	HSC-221R	HB-71
		HSB-221	HB-54
		HSB-221N	HB-54
		NS6-221	
		NS4-221	

Detector Model	Identifier	Base Model	Identifier
SOC-24V	HD-3	HSB-221	HB-54
		NS6-221	HB-4
		NS4-221	HB-4
		NS6-220	HB-3
SOC-24VN	HD-3	HSB-221	HB-54
		NS6-221	HB-4
		NS4-221	HB-4
		NS6-220	HB-3
FENWAL (Max. No. Of Detectors Per Zone Is 25)			
CPD-7051*	I51FE1	2-WIRE	FE51A
PSD-7155*	P55FE1	2WRLT	FE52A
PSD-7156*	P56FE1	2WRB	FE55A
All of the above Fenwal detectors and bases can be used in any combination. Retrofit Base Adaptor 70-501000-003, Identifier MAFE1 (for series 70-201000 Bases, Models -001, -002, -003, and -005). Duct Housing with Detector Base DH-51, Identifier DH22FE5 (for CPD-7051 and PSD-7155 detectors only).			
POTTER (Max. No. Of Detectors Per Zone Is 25)			
PS-24*	HD-3 (HOCHIKI)	SB-46	HB-71(HOCHIKI)
			HB-54 (HOCHIKI)
		SB-93	HB-3 (HOCHIKI)
PS-24H	HD-3 (HOCHIKI)	SB-46	HB-71 (HOCHIKI)
			HB-54 (HOCHIKI)
IS-24*	HD-3 (HOCHIKI)	SB-46	HB-71 (HOCHIKI)
			HB-54 (HOCHIKI)
CPS-24	HD-3 (HOCHIKI)	SB-46	HB-4 (HOCHIKI)
		SB-93	HB-3 (HOCHIKI)
CPS-24N	HD-3 (HOCHIKI)	SB-46	HB-4 (HOCHIKI)
		SB-93	HB-3 (HOCHIKI)
*UL Listed.			
NOTE: If using a mix of System Sensor and other smoke detectors, a maximum of 20 detectors shall be permitted.			

Appendix F – Compatible Auxiliary Circuit Devices

Table 26: Door Holders & Other Accessories	
Model	Description
Door Holders (UL listed devices by RSG Inc.)	
1430200 DH24120FPC	Semi-flush, powder coated, chrome
1430201 DH24120FB	Semi-flush, plated, brass
1430202 DH24120FD	Semi-flush, powder coated, dark bronze
1430203 DH24120SPC	Surface mount, powder coated, chrome
1430204 DH24120SB	Surface mount, plated, brass
1430205 DH24120SPD	Surface mount, powder coated, dark bronze
1430206 DH24120RPC	Recessed, powder coated, chrome
1430207 DH24120RB	Recessed, plated, brass
1430208 DH24120RD	Recessed, powder coated, dark bronze
1430209 DH24120GPC1	Ground mount, single door, powder coated, chrome
1430210 DH24120GB1	Ground mount, single door, plated, brass
1430211 DH24120GPD1	Ground mount, single door, powder coated, dark bronze
1430212 DH24120GPC2	Ground mount, double door, powder coated, chrome
1430213 DH24120GB2	Ground mount, double door, plated, brass
1430214 DH24120GPD2	Ground mount, double door, powder coated, dark bronze
Flow Switches (UL listed devices by Potter Electric Signal Company, LLC)	
1116102	VSR-AT 2 Inch Auto Test
1116103	VSR-AT 3 Inch Auto Test
1116104	VSR-AT 4 Inch Auto Test
1116105	VSR-AT 5 Inch Auto Test
1116106	VSR-AT 6 Inch Auto Test
1116108	VSR-AT 8 Inch Auto Test
1116125	VSR-AT 2 1/2 Inch Auto Test
1116135	VSR-AT 3 1/2 Inch Auto Test

Appendix G – Control Panel Menu

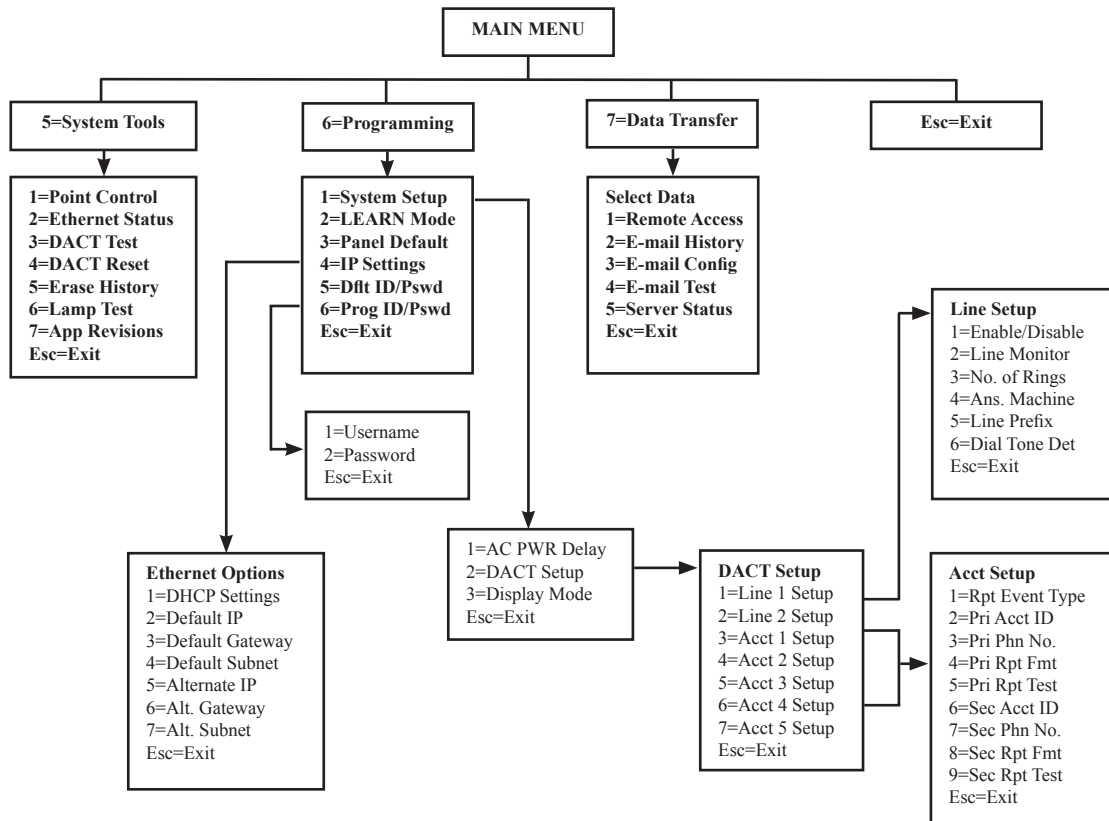
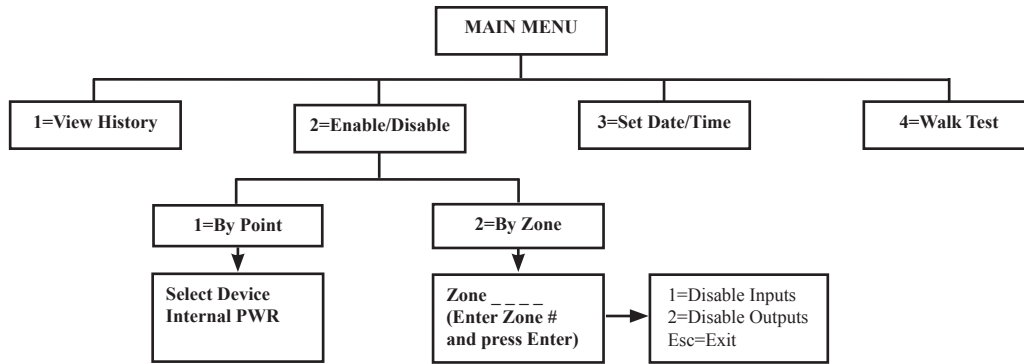

TIP: To save time, enter the menu selection number on the keypad to select a function. For example, press “3” to select “Set Date/Time” from the Main Menu.

Normal Standby	The green AC POWER LED will be illuminated and the user defined message on the LCD will be displayed. If the AC power is removed for more than 5 seconds, the green AC power LED will extinguish.
Acknowledging	Off normal events are acknowledged by pressing the ACK key after scrolling down to new event. After all events have been acknowledged, the buzzer will deactivate and the associated LED will stop flashing and remain on continuously.
Alarm Condition	The red ALARM LED will be flashing until it is Acknowledged, then it will display steady red anytime an alarm is occurring in the system. The LCD will display the number of inputs in alarm, and the buzzer will be activated. The buzzer will remain active until all alarms have been acknowledged, or until the Silence key is pressed.
Silencing Alarm	When the system is in Alarm, the notification circuits (strobes and horns) can be shut off by pushing the SILENCE button. The Silence LED will change status from flashing to steady. A programmable Automatic Silence will also shut off notification circuits. The Silence LED will remain flashing until the event is acknowledged.
Resetting Alarm	After the condition that caused the alarm has been identified and corrected, the system may be reset to the Normal Standby by pressing the RESET button.
Supervisory Condition	When a supervisory condition is detected, the amber SUPERVISORY LED will illuminate and the buzzer will sound. The LCD display will indicate the number of supervisory events that are active. The local buzzer will sound until all supervisory events have been acknowledged.
Restoring Supervisory Condition	If the Supervisory condition is non-latching, once the device is restored to the normal condition, the supervisory event will clear. If the supervisory condition is latching, the device that was activated must be restored and the RESET pressed.
Trouble Condition	When a fault condition occurs, the amber TROUBLE LED will illuminate and the local buzzer will sound until the fault is removed or the ACK button is pressed acknowledging the trouble condition. If the buzzer is acknowledged and the fault is not removed within 24 hours, the buzzer will resound.
Silencing Trouble(s)	When a trouble is occurring, the local buzzer will sound until either all troubles have been acknowledged or the SILENCE button is pressed.
Ground Fault	When a conductor contacts and earth ground, the amber EARTH FAULT LED will illuminate and the LCD display will provide further information of where the fault is located.
Alarm Signal Activation	Press left and right arrow keys at the same time.
Testing and Maintenance	Test this system monthly or more frequently as required by the AHJ. Before conducting any testing contact the building personnel and the monitoring facility as applicable. When testing a system configured for releasing, activate the releasing disconnect switch to prevent accidental discharge of a suppression system. Test the circuits as outlined in the Installation Manual. Test in accordance with NFPA 72 Inspection, Testing and Maintenance Chapter(s) and any local requirements. The batteries should be marked with the date of installation and replaced every four years or sooner if battery trouble occurs. Batteries should be checked with a tester acceptable to the AHJ such as a Stone Technologies model STC612A or equivalent. In case of a fuse replacement, refer to the Installation Manual for the proper rating. Contact the agency below for service or operational questions.

For service, contact:

Name: _____

Company: _____

Address: _____

Telephone: _____

Frame and display instructions adjacent to the fire alarm panel.

PFC-6006 Quick Start Guide

Overview: The *Quick Start Guide* explains how to quickly setup your Potter PFC-6006 Sprinkler Monitoring panel by using the panel's default settings, and the built-in DACT (*i.e.*, *phone line communicator*). These step-by-step programming instructions show you how to program the DACT's settings using the panel's keypad to efficiently get the system operational.

Default Settings: The PFC-6006 Sprinkler Monitoring panel includes the following default settings:

- **Input Zone 1 – Waterflow**
- **Input Zone 2 – Smoke Detector**
- **Input Zone 3 – Pull Station**
- **Input Zone 4 – Supervisory (Non-latching)**
- **Input Zone 5 – Tamper (Latching)**
- **Input Zone 6 – Tamper (Latching)**
- **NAC – General Purpose (no Strobe Sync)**

Note: If you choose to change the panel's default settings, you must use Potter's Fire Panel programming software installed on a computer. Please see the *PFC-6006 Sprinkler Monitoring Panel's Installation, Operation & Programming Guide (Manual #5403559–Rev A)* for detailed instructions on changing defaults, enabling the e-mail features or programming the IP communicator.

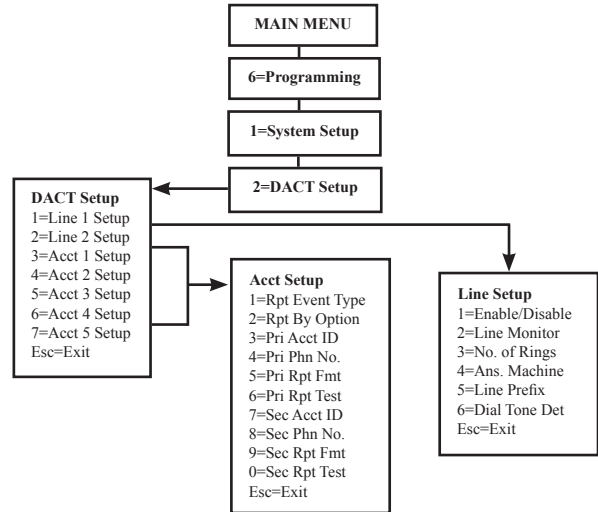

Control Panel Menu Tree – DACT Setup







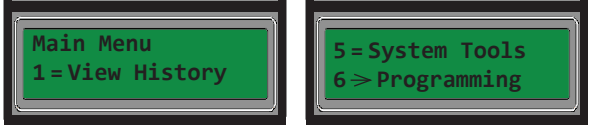

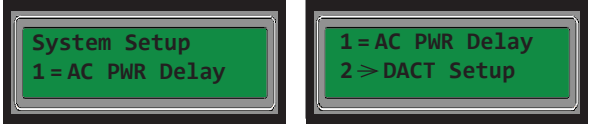

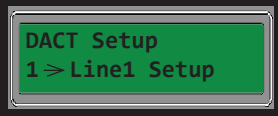

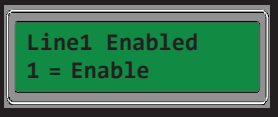
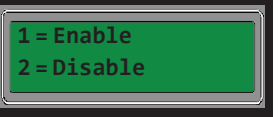
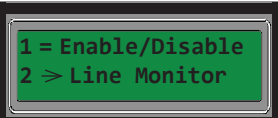
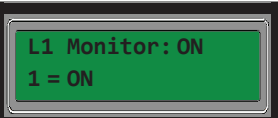

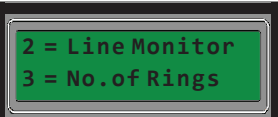
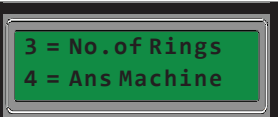
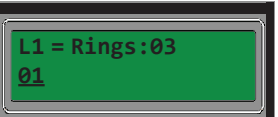
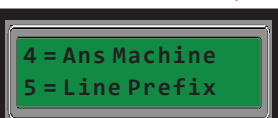
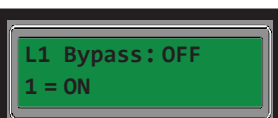

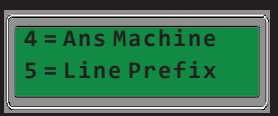
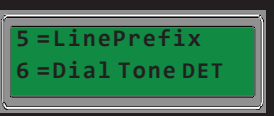

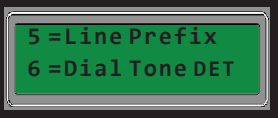





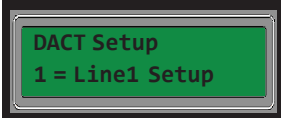
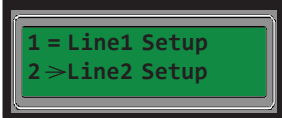

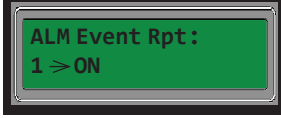

Programming the DACT (Dialer) Via the Keypad

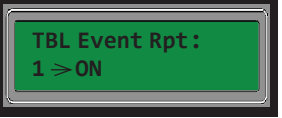
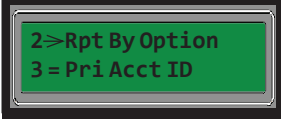
Programming Notes:

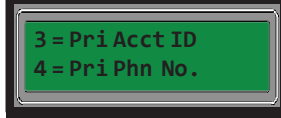
- You may choose to use the DACT's default settings for some of the options, which will speed up programming. For your convenience, the defaults are shown at the beginning of each option. If you want to use an option's default, skip that step and go onto the next one.
- There are 2 ways to select menu options: (1) by scrolling up/down using the *keypad arrows* and pressing the "Enter" key or (2) by entering the *menu option number*. Both methods are provided in Steps 1-12; after that point, only the *menu option number* method is shown.
- For an in-depth overview of programming the DACT, view our on-line training video located at Potter's website as follows: www.pottersignal.com, *Fire Alarm Systems – Training*, select *Go to Training videos*. Next, click the *Additional Fire Training button* and scroll to the *PFC-6006 DACT* video.

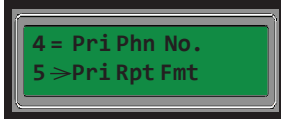
KEYPAD STEPS	PANEL MENU OPTIONS
1. From the panel's keypad, press Enter to display the Main Menu . <ul style="list-style-type: none"> • Press the <i>down arrow</i> to scroll to "Programming" and press Enter. -OR- • Enter "6" – Programming. • Enter "1111" as the programming password code. • Press Enter or "1" – System Setup. 	
2. From the " System Setup " menu: <ul style="list-style-type: none"> • Press <i>down arrow</i> to scroll to "DACT Setup" and press Enter. -OR- • Enter "2" – DACT Setup. 	
	

KEYPAD STEPS	PANEL MENU OPTIONS
<p>Setup Phone Lines 1 & 2:</p> <p>3. Press Enter or "1" – Line1 Setup.</p> <p>4. Press Enter or "1" – Enable/Disable.</p> <p>[Line's <u>current</u> status displays.]</p> <ul style="list-style-type: none"> Enter "1" to Enable. -OR- Enter "2" to Disable or scroll down & press Enter. <p>[Line's <u>updated</u> status displays briefly.]</p> <p>5. Scroll to "Line Monitor" and press Enter.</p> <p>-OR-</p> <p>Enter "2" – Line Monitor.</p> <p>[Line's <u>current</u> line monitor setting displays.]</p> <ul style="list-style-type: none"> Enter "1" – ON or "2" – OFF. 	<p>Line's Default = Enabled. (The DACT can access the telephone line.)</p>     <p>[If changes are made, the "Line Enabled - Change Success" message displays; however, if <u>no</u> changes are made, the "No Changes" message displays.]</p> <p>Line Monitor Default = Enabled. (This tells the DACT to monitor the phone line's voltage; if the line's voltage is not present or low, a "Trouble" error displays.)</p>    <p>[Line's <u>updated</u> monitor setting & "Change Success" or "No Changes" displays.]</p>
<p>6. Scroll to "No. of Rings" and Enter.</p> <p>-OR-</p> <p>Enter "3" – No. of Rings.</p> <p>[Line's <u>current</u> no. of rings displays.]</p> <ul style="list-style-type: none"> Enter the number of rings that the panel will wait before answering, if any. Press Enter. <p>7. Scroll to "Ans Machine" and Enter.</p> <p>-OR-</p> <p>Enter "4" – Ans Machine.</p> <p>[Line's <u>current</u> answering machine bypass setting displays.]</p> <ul style="list-style-type: none"> Enter "1" – ON or "2" – OFF. 	<p>No. of Rings Default = 3 rings. (This tells the DACT to pick up or answer incoming phone calls after 3 rings. This option is used only if remote programming is required.)</p>    <p>[Line's <u>updated</u> no. of rings & "Change Success" or "No Changes" displays.]</p> <p>Answering Machine Bypass Default = OFF. (This setting is used or turned "ON" only if remote programming is required, and the panel shares the phone line with another device, i.e., FAX machine).</p>    <p>[Line's <u>updated</u> ans. machine bypass & "Change Success" / "No Changes" displays.]</p>
<p>8. Scroll to "Line Prefix" and Enter.</p> <p>-OR-</p> <p>Enter "5" – Line Prefix.</p> <p>[Line's <u>current</u> line prefix setting displays.]</p> <ul style="list-style-type: none"> Press up/down arrows to select the appropriate prefix or pause character, if required at your site. Press Enter. 	<p>Line Prefix Default = None. ((This setting assumes that the DACT can directly access an outside phone line without dialing an prefix (such as an "9") or waiting for the phone line to connect. Enter a ", " (comma) for each 1 second or pause that is required.))</p>    <p>[Press up/down arrows repetitively to view the pause characters & prefix numbers.]</p> <p>[Line's <u>updated</u> prefix setting & "Change Success" / "No Changes" displays.]</p>
<p>9. Scroll to "Dial Tone Det" and Enter.</p> <p>-OR-</p> <p>Enter "6" – "Dial Tone DET."</p> <p>[Line's <u>current</u> dial tone setting displays.]</p> <ul style="list-style-type: none"> Enter "1" – ON or "2" – OFF. 	<p>Dial Tone Detection Default = ON. (The DACT listens for a phone line's dial tone, before calling out to the central station.)</p>    <p>[Line's <u>updated</u> dial tone setting & "Change Success" / "No Changes" displays.]</p>

KEYPAD STEPS	PANEL MENU OPTIONS
<p>10. Press ESC when all information has been completed for Line 1.</p> <p>11. Scroll to "Line2 Setup" and Enter. -OR- Press "2" – Line2 Setup.</p> <p>12. Setup Line2's options; please refer to Steps 3 – 10.</p>	 [Press ESC to display the " <i>DACT Setup</i> " menu.]   [Repeat Steps 3 – 10 to setup Line2.] [Press ESC after Line2 is setup to redisplay the " <i>DACT Setup</i> " menu.]
<p>Setup Account #1:</p> <p>13. Press "3" – Acct1 Setup.</p> <ul style="list-style-type: none"> Press "1" – Rpt Event Type. [Acct1's <u>current</u> report event type settings display.] Press Enter to setup ALM, SUP & TBL event types. Press "1" – ON or "2" – OFF. [Acct1's <u>updated</u> report event type & "<i>Change Success</i>" / "<i>No Changes</i>" displays.] 	<p>Report Event Type Default = None. (<i>The DACT will <u>not</u> report any Alarms, Supervisory or Troubles when they occur.</i>)</p>    [This displays if no event types have been setup.]   
<p>14. Enter "2" for "Rpt By Option." [Acct1's <u>current</u> report by option setting displays.]</p> <ul style="list-style-type: none"> Select the applicable "<i>report by</i>" option. Enter "1" – Panel, "2" – Zone, or "3" – Point. 	<p>Report By Option Default = Point. (<i>The DACT <u>reports by point</u> any Alarms, Supervisory or Troubles when they occur.</i>)</p>    [Acct1's <u>updated</u> report by option & " <i>Change Success</i> " / " <i>No Changes</i> " displays.]
<p>15. Enter "3" – Pri Acct ID, and enter the primary account ID.</p> <p>16. Enter "4" – Pri Phn No., and enter the primary phone number provided by your central station.</p>	<p>Check with your <u>central station</u> for the information <u>required</u> in the next 2 fields:</p> <ul style="list-style-type: none"> Primary Account ID Default = None. (<i>You must enter the <u>specific</u> account ID.</i>) Phone No. Default = None. (<i>You must enter the <u>specific</u> phone number.</i>)   
<p>17. Enter "5" – Pri Rpt Fmt. [Acct1's <u>current</u> report format displays.]</p> <ul style="list-style-type: none"> Press "1" – SIA or "2" – CID. [Acct1's <u>updated</u> report format & "<i>Change Success</i>" / "<i>No Changes</i>" displays.] <p>18. Enter "6" – Pri Rpt Test. [Acct1's <u>current</u> report test setting displays.]</p> <ul style="list-style-type: none"> Press "1" – ON or "2" – OFF. [Acct1's <u>updated</u> report test setting & "<i>Change Success</i>" / "<i>No Changes</i>" displays.] 	<p>Report Format Default = CID. (<i>CID is the most common report format; check with your central station for verification.</i>)</p>   <p>Primary Report Test Default = OFF. (<i>The DACT will <u>not</u> report a daily test signal to the primary account's alarm receiver.</i>)</p>  

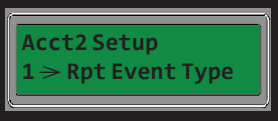
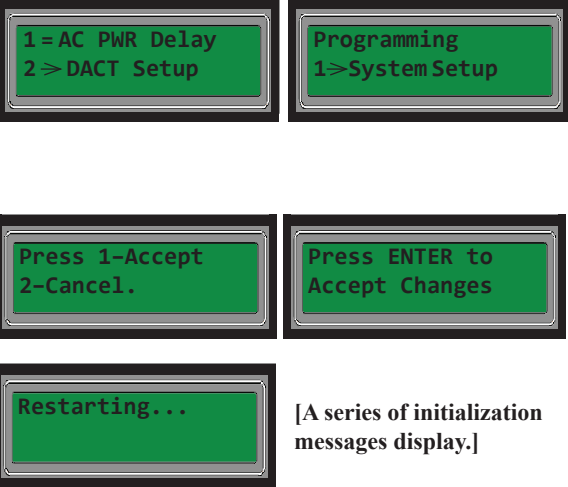
KEYPAD STEPS	PANEL MENU OPTIONS
<p>19. Enter "7" – Sec Acct ID, and enter the secondary account ID provided by your central station.</p> <p>20. Enter "8" – Sec Phn No. and enter the secondary phone number provided by your central station.</p> <p>21. Enter "9" – Sec Rpt Fmt; press "1" – SIA or "2" – CID.</p> <p>22. Enter "0" – Sec Rpt Test; press "1" – ON or "2" – OFF.</p> <p>23. Press ESC to display the "DACT Setup" menu.</p>	 <p>The panel displays a sequence of menu options: <ul style="list-style-type: none"> Step 19: 6 = Pri Rpt Test, 7 = Sec Acct ID. ID: _____ Step 20: 7 = Sec Acct ID, 8 > Sec Phn No. Phn: _____ Step 21: 8 = Sec Phn No., 9 = Sec Rpt Fmt. Fmt: CID, 1 > SIA Step 22: 9 = Sec Rpt Fmt, 0 > Sec Rpt Test. Test: OFF, 1 > ON Step 23: 2 = Line2 Setup, 3 > Acct1 Setup </p>
<p>Setup Account(s) 2-5, if used at site, otherwise: <i>[Skip to Step #26 when finished.]</i></p> <p>24. Repeat Steps 13-23 for each additional Account used at your site.</p> <p>25. From the "DACT Setup" menu:</p> <ul style="list-style-type: none"> • Enter "4" – Acct2 Setup. • Enter "5" – Acct3 Setup. • Enter "6" – Acct4 Setup. • Enter "7" – Acct5 Setup. 	<p><i>[Repeat Steps #13-23 to setup Accounts 2-5, if needed!]</i></p>  <p><i>[Skip to Step #26 when finished.]</i></p>
<p>26. Press ESC to exit the "DACT Setup" menu.</p> <ul style="list-style-type: none"> • Press ESC again to exit the "System Setup" menu. • Press ESC a 3rd time to exit the "Programming" menu. • Press "1" to Accept (or save all changes). -OR- • Press "2" to Cancel (or not save changes). • Press Enter to accept and save changes. • Panel restarts to complete updated DACT settings. 	 <p>The panel displays the following messages: <ul style="list-style-type: none"> 1 = AC PWR Delay, 2 > DACT Setup Programming, 1 > System Setup Press 1-Accept, 2-Cancel. Press ENTER to Accept Changes Restarting... </p> <p><i>[Panel beeps until you press "ENTER" to continue -OR- "ESC" to not save changes.]</i></p> <p><i>[A series of initialization messages display.]</i></p>