

FMR-7033



EN | Installation Instructions
Addressable Fire System
Controller

Contents

Contents	2
1.0 Introduction	3
2.0 Description	3
3.0 Device Mounting	3
3.1 Mounting the FMR-7033 to a Surface	3
3.2 Mounting the FMR-7033 to an Electrical Box	3
4.0 Wiring the FMR-7033	4
5.0 Powering the FMR-7033	4
6.0 Installing the FMR-7033 Instruction Label and Slide	5
7.0 Setting the FMR-7033's Address	5
8.0 Programming the FMR-7033	5
9.0 Troubleshooting the FMR-7033	5
10.0 Specifications	6
11.0 Operating the FMR-7033	7

Figures

Figure 1: Removing the FMR-7033 Cover	3
Figure 2: Location of the FMR-7033 Base Mounting Holes	4
Figure 3: Wiring the FMR-7033's Terminal Strip....	4
Figure 4: Installing the Instruction Label and Slide.	5
Figure 5: FMR-7033 Keypad Addresses	5
Figure 6: Keypad Features.....	7

Tables

Table 1: FMR-7033 Wiring Guidelines	4
Table 2: FMR-7033 Troubleshooting Tips	6
Table 3: FMR-7033 Specifications.....	6

1.0 Introduction

These instructions cover the installation of the Bosch Security Systems, Inc. (Bosch) FMR-7033 Addressable Fire System Controller in a fire system supervised by a Bosch FPD-7024 Fire Alarm Control Panel (FACP).



Follow these instructions to avoid personal injury and/or damage to equipment.



Install, test, and maintain these devices according to these instructions, NFPA 72, Local Codes, and the Authority Having Jurisdiction (AHJ). Failure to follow these instructions might result in failure of the device to initiate a proper response. Bosch is not responsible for improperly installed, tested or maintained devices.

2.0 Description

The FMR-7033 Addressable Fire System Controller is a four-wire alphanumeric LCD keypad that combines fire system annunciator and controller functions. It operates identically to the built-in user interface on the FACP. Up to four FMR-7033 controllers might be connected to an FPD-7024.

The FMR-7033 can be surface mounted, mounted to a single or double gang box or to a four-inch square box.

3.0 Device Mounting

The FMR-7033 should be mounted no higher than shoulder height of the shortest person using the system.

Remove the keypad's cover by inserting a small flat-head screwdriver in each slot at the bottom of the base. Press up and pull the cover off (*Figure 1*).

Figure 1: Removing the FMR-7033 Cover

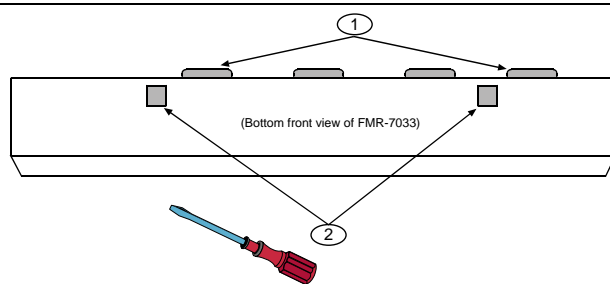

- 1 - Keypad Keys
- 2 - Insert small flat screwdriver in each slot to remove FMR-7033 cover

3.1 Mounting the FMR-7033 to a Surface

1. Use the base as a template and mark the location of the mounting holes (use any holes).
2. Provide an opening in the mounting surface for the wiring.
3. Partially install the mounting screws.



Do not tighten the mounting screws.

3.2 Mounting the FMR-7033 to an Electrical Box

Refer to *Figure 2* on page 5 to select mounting holes. Do not tighten the mounting screws.

Figure 2: Location of the FMR-7033 Base Mounting Holes

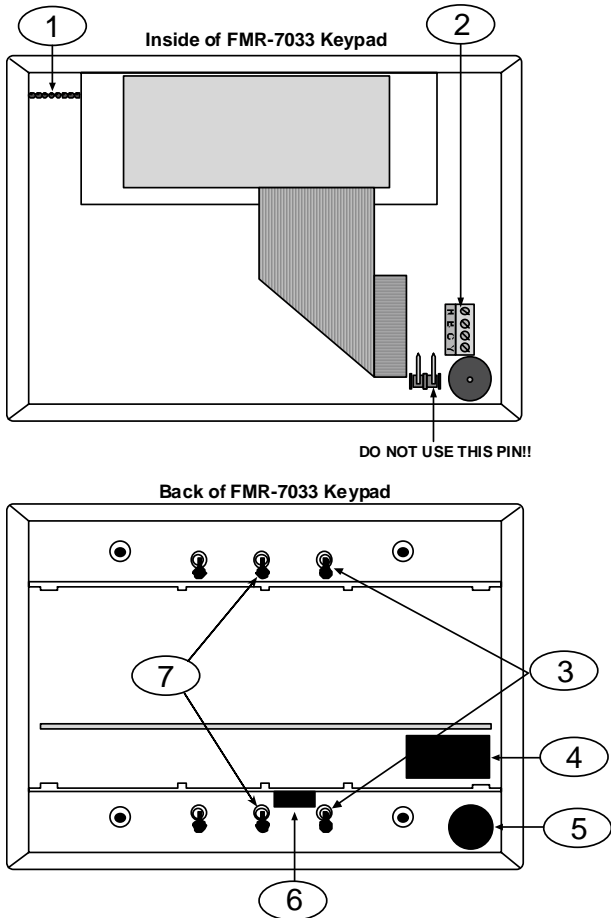

- 1- Address Pins
- 2- Terminal Strip
- 3- Double Gang Mounting Slots
- 4- Terminal Strip Opening
DO NOT USE AS A WIRE ENTRANCE.
- 5- Sounder Opening
- 6- Wire Entrance
- 7- Single Gang Mounting Slots

4.0 Wiring the FMR-7033



-  Ensure that power is removed from all wiring before routing. Keypad wiring cannot be shared with multiplex, option bus, telephone or siren wiring.
-  Up to three keypads can be used on any single 1,000 ft (305 m) run of #18 AWG (1.2 mm) wire. Refer to the FACP's installation guide for more detailed instructions.

Table 1: FMR-7033 Wiring Guidelines

Wiring Specifications	Value
Wire Gauge	#18 AWG (1.2 mm)
Wire Type	Non-shielded; 4-wire
Maximum number of keypad allowed per system	4
Distance allowed between FACP and Keypad	2000 ft (610 m)
Maximum distance of keypad wiring and bus	4000 ft (1219 m)

To wire the FMR-7033 Fire System Controller:

1. Route the wiring from the FACP to the keypads. Refer to the FACP's installation guide for details.
2. Bring the base wiring through the wire entrance in the keypad's base. Refer to *Item 6 in Figure 2* for wire entrance location.
3. Connect the wiring to the FMR-7033's terminal strip. Refer to *Figure 3*.
4. Place the keypad onto the base.
5. While feeding the excess wiring out of the rear of the base, press the cover straight in until it latches.

Figure 3: Wiring the FMR-7033's Terminal Strip

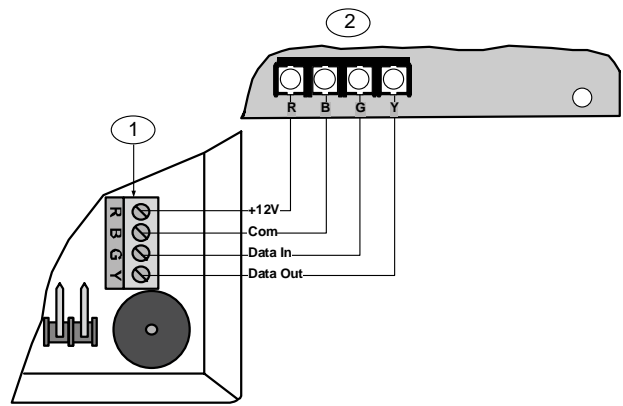

- 1 - FMR-7033 Terminal Strip
- 2 - FPD-7024 Option Bus

5.0 Powering the FMR-7033

The power supplied to the FMR-7033 from the R and B terminals on the FACP is 12 VDC with a maximum draw of 100 mA per FMR-7033 keypad. This power is supplied from a 24 VDC battery when AC power fails.

For battery standby calculations, assume that the FMR-7033 draws 75 mA from the 24 VDC battery. The FPD-7024 FACP uses a switching power supply to convert 24 VDC battery power to 12 VDC option bus power. This conversion reduces the current drawn from the battery.

6.0 Installing the FMR-7033 Instruction Label and Slide

An instruction label is provided for placement on the pullout slide. The slide can be installed to pull from the left or right (slide it into rear of base).

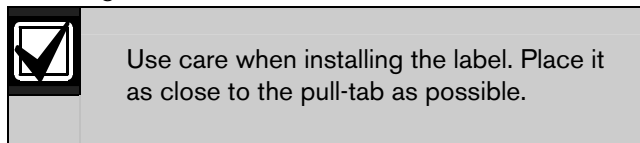
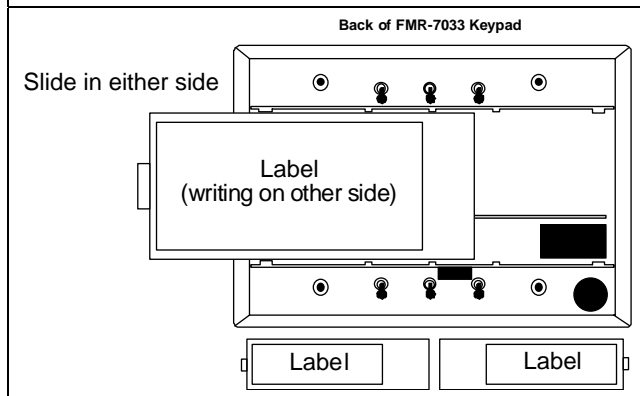
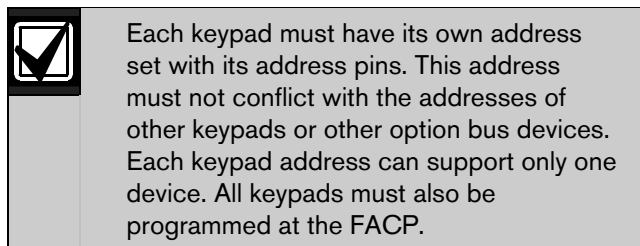

Figure 4: Installing the Instruction Label and Slide



7.0 Setting the FMR-7033's Address



Select the keypad address (1-15) by placing the shorting jumpers over the address pins as shown in *Figure 5*.

Figure 5: FMR-7033 Keypad Addresses

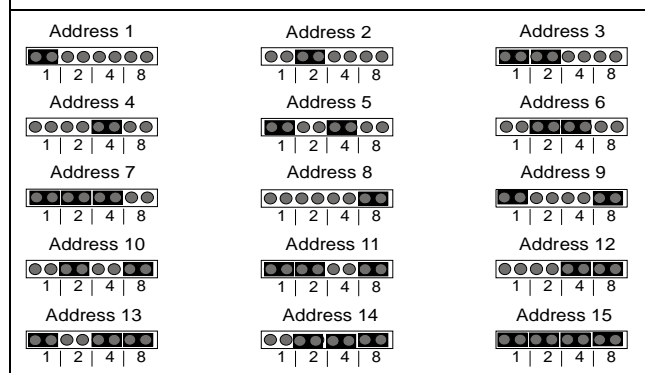

8.0 Programming the FMR-7033

The control panel does not recognize the keypad until the option bus is updated.

To update the option bus from the local keypad:

1. Enter programming mode using the correct programming code.
2. Select menu item 3 – System.
3. Select menu item 4 – Option Bus
4. Select menu item 1 – Update Bus
5. Press */back to exit from programming mode.

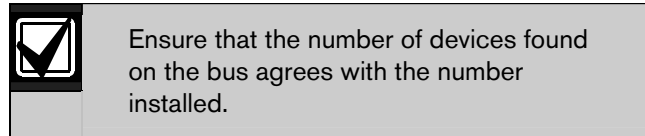

9.0 Troubleshooting the FMR-7033

Refer to *Table 2* on page 6 when troubleshooting problems with the FMR-7033.

Table 2: FMR-7033 Troubleshooting Tips

FMR-7033 Keypad Notification	Possible Causes
Continuous keypad sounder plus "System Fault" display	<ul style="list-style-type: none"> - The yellow and green ground wires are disconnected. - The keypad is not programmed properly at the FACP. - The FACP malfunctioned. Replace the FACP.
FACP does not respond to keypad input	<ul style="list-style-type: none"> - The keypad's address was not set.
Three-beep error tone at all keypads	<ul style="list-style-type: none"> - Invalid key input.

10.0 Specifications

Table 3: FMR-7033 Specifications

Nominal Supply Voltage	12 VDC from Option Bus
Standby Current	100 mA (75 mA for battery calculation)
Alarm Current	100 mA (75 mA for battery calculation)
Environment	Use Indoor/Dry
Operating Temperature	+32°F to 120°F (0°C to +49°C)
Relative Humidity	93%
Width	6.25 in (15.9 cm)
Height	4.6 in (11.7 cm)
Depth	1.3 in (2.9 cm)
Listings and Approvals	UL864, FM
Wiring	Supervised Communication Circuit Class B, Style 4

11.0 Operating the FMR-7033

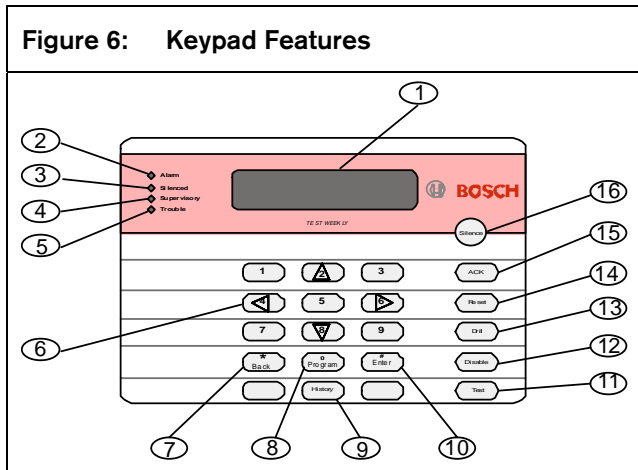

1. The two-line character display can show all messages normally displayed on an FPD-7024 or an FMR-7036 keypad.
2. The red Alarm LED lights whenever the system registers an alarm and was not reset.
3. The yellow Silenced LED lights when the user manually silences an alarm or trouble condition. It turns off when the condition that was silenced is corrected.
4. The yellow Supervisory LED lights whenever the system registers a supervisory condition.
5. The yellow Trouble LED lights whenever the system detects a problem with wiring or internal circuitry. The Trouble LED flashes while programming mode is active and whenever inputs are not active, such as during smoke power reset or alarm verification.
6. Scroll keys are used to move through the off-normal events indicated on the display.
7. During the programming, use the [Back] key to exit from menus or exit from the programming mode entirely.
8. Use the [Programming] key to select the programming mode.
9. Use the [History] key to view system events.
10. Use the [Enter] key to accept data when in the programming mode.

11. Use the [Test] key to select one of seven special test modes (refer to FPD-7024 O&I Guide; P/N F01U008458).
12. Use the [Disable] key to disable or re-enable inputs NACs or relays (outputs), and the dialer.
13. Use the [Drill] key to activate the NACs manually. It creates a history log entry and can be optionally reported to the central station.
14. The [Reset] key (programmable from 1 to 16 sec) briefly turns off power to the detectors to reset them and clears any off-normal conditions.
15. Use the [Acknowledge] key to silence local keypad sounders and to view off-normal conditions.
16. The [Silence] key quiets the bell or sirens for an alarm or trouble condition only if the system is so configured.

Bosch Security Systems, Inc.
130 Perinton Parkway
Fairport, NY 14450-9199
(800) 289-0096
www.boschsecurity.com

© 2008 Bosch Security Systems, Inc.
F01U010583-01



BOSCH