

**NO  
EXCUSES!**

# RJ Series

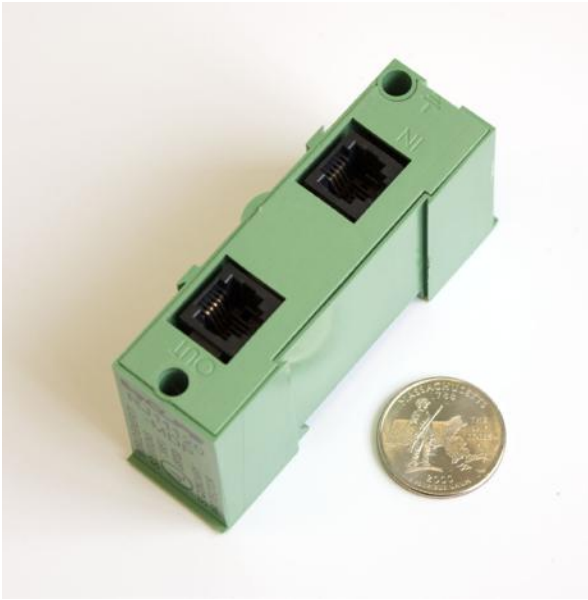

## Low Voltage Surge Protection Device

The first and only Transient Voltage Surge Suppressor (TVSS) ever designed that is truly scalable. Ideal for moves, adds, and changes in system layout. Maintains system integrity and protects against transients introduced into wiring serving sensitive electronics. Reduces downtime associated with power surges and lightning strikes. Prevents the interruption of Recurring Monthly Revenue (RMR) based systems. Eliminates nuisance and non-billable service calls.

### Commonly used on:

Fire or Burglary 31X alarm dialers and building entrance telephone lines

### Typical applications:

Fire, Burglary, and Telephone systems

## Standard Features:

- Fully scalable
- Connection methods: RJ11, RJ14, RJ45, RJ 31X
- UL 497A listed
- Available application voltages: 5, 12, 24, 48, 75, 90, 130
- Single point grounding
- Self restoring
- Field Swappable Modules.

 - Uses UL Recognized Components



**LISTED**

Made In  U.S.A.



**ECLIPS**

Space Age Electronics, inc.  
www.1SAE.com  
**800.486.1723** Toll Free  
508.485.0966 Local  
508.485.4740 Fax

## RJ Series MD, MDP- Product Specifications

### Specifications – Operating:

<b>Service Voltage:</b>	6(5v) 17(12v) 30(24v) 60(48v)
<b>Circuits Protected:</b>	RJ 11- 2wire, RJ 14 - 4 wire, RJ 31x - 2 wire, RJ 45 - 8 wire
<b>Installation Configuration:</b>	Series
<b>Ground Type:</b>	Lug

### Specifications – Performance:

<b>Maximum Surge Current:</b>	4,000A 4,000A 4,000A 18,000A
<b>Energy Dissipation Joules:</b>	28(5v) 32(12v) 40(24v) 80(48v) 132(70v) 160(90v) 212(120v)
<b>Capacitance @1kHz: (pF)</b>	11,133 9,133 7,433 3,633 2,033 1,733 1,333
<b>Clamping Response Time:</b>	<1 Pico Second
<b>Current Limiting:</b>	MD - No   MDP - Yes
<b>Maximum Continuous Current:</b>	MD - 5A   MDP - 150 mA
<b>Maximum Operating Voltage (MCOV):</b>	6(5v) 14.4(12v) 28.8(24v) 57.6(48v) 84(70v) 108(90v) 144(120v)
<b>Clamping Voltage: VDC</b>	9 (5v) 17(12v) 34(24v) 65(48v) 95(70v) 122(90v) 168(120v)
<b>Operation Indicators:</b>	None

### Specifications – Compliance:

<b>UL Listed</b>	MD - UL 497B   MDP - UL 497A
------------------	------------------------------

### Specifications – Physical:

<b>Weight</b>	2.08 Oz
<b>Height</b>	1.6 inches
<b>Length</b>	3.1 inches
<b>Width</b>	.92 inches
<b>Operation Temperature: Centigrade</b>	45
<b>Maximum Humidity</b>	85%
<b>Plastic Flame Rating</b>	V-5

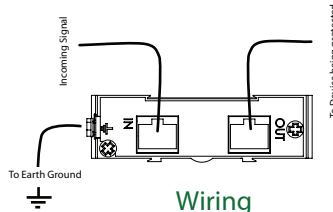
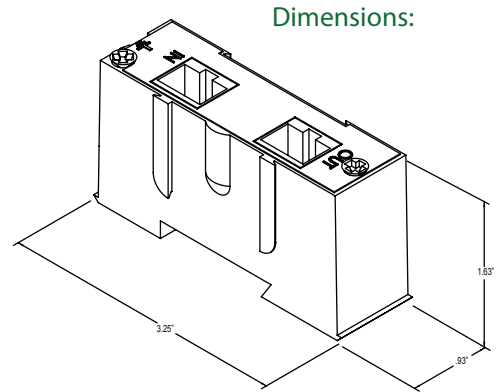

Wiring

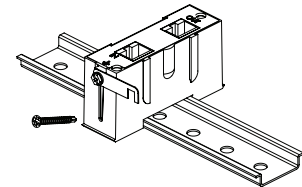

35mm Din-Rail Mount

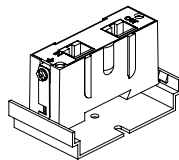

Snap Track Mount

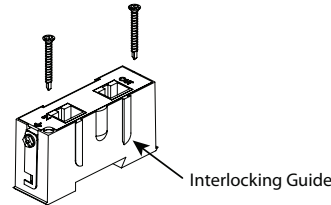

Screw Mount

Model No.	Description	Model No.	Description
RJ31120-MD	120v RJ31	RJ31120-MDP	120v RJ31 Current Limiting

Model No.	Description	Model No.	Description
RJ1405-MD	5v RJ14	RJ1405-MDP	5v RJ14 Current Limiting
RJ1412-MD	12v RJ14	RJ1412-MDP	12v RJ14 Current Limiting
RJ1424-MD	24v RJ14	RJ1424-MDP	24v RJ14 Current Limiting
RJ1448-MD	48v RJ14	RJ1448-MDP	48v RJ14 Current Limiting
RJ1470-MD	70v RJ14	RJ1470-MDP	70v RJ14 Current Limiting
RJ1490-MD	90v RJ14	RJ1490-MDP	90v RJ14 Current Limiting
RJ14120-MD	120v RJ14	RJ14120-MDP	120v RJ14 Current Limiting

Model No.	Description
RJ4505-MD	5v RJ45
RJ4512-MD	12v RJ45
RJ4524-MD	24v RJ45
RJ4548-MD	48v RJ45
RJ4570-MD	70v RJ45
RJ4590-MD	90v RJ45
RJ45120-MD	120v RJ45

Model No.	Description
RJ4505-MDP	5v RJ45 Current Limiting
RJ4512-MDP	12v RJ45 Current Limiting
RJ4524-MDP	24v RJ45 Current Limiting
RJ4548-MDP	48v RJ45 Current Limiting
RJ4570-MDP	70v RJ45 Current Limiting
RJ4590-MDP	90v RJ45 Current Limiting
RJ45120-MDP	120v RJ45 Current Limiting

Model No.	Description
RJ1105-MD	5v RJ11
RJ1112-MD	12v RJ11
RJ1124-MD	24v RJ11
RJ1148-MD	48v RJ11
RJ1170-MD	70v RJ11
RJ1190-MD	90v RJ11
RJ11120-MD	120v RJ11

Model No.	Description
RJ1105-MDP	5v RJ11 Current Limiting
RJ1112-MDP	12v RJ11 Current Limiting
RJ1124-MDP	24v RJ11 Current Limiting
RJ1148-MDP	48v RJ11 Current Limiting
RJ1170-MDP	70v RJ11 Current Limiting
RJ1190-MDP	90v RJ11 Current Limiting
RJ11120-MDP	120v RJ11 Current Limiting



Space Age Electronics, inc.  
 www.ISAE.com  
 800.486.1723 Toll Free  
 508.485.0966 Local  
 508.485.4740 Fax

No Excuses, Just Solutions!

This document is subject to change without notice, see doc # ED0479 for legal disclaimer