



BOSCH

Conettix Plug-in Communicator

B450/B450-M



en

Installation Manual

Table of contents

1	Safety	4
2	Introduction	5
2.1	About documentation	5
2.2	Bosch Security Systems, Inc. product manufacturing dates	5
2.3	Installation workflow	6
3	System overview	7
3.1	Module overview	7
3.2	Cellular interface compatibility	8
3.3	Bus address settings	9
4	Installation	12
4.1	Inserting a plug-in cellular module (required)	12
4.2	Mounting the module	13
4.3	Installing the tamper switch (optional)	14
4.4	Installing the cellular antenna	14
4.5	Connecting the module to the control panel	15
4.5.1	Connecting to SDI2 and SDI control panels	15
4.5.2	Connecting to option bus control panels	16
5	Configuration	17
5.1	Configuration parameters	17
5.2	Plug and Play (PnP) configuration	21
5.2.1	RPS configuration	21
5.3	USB configuration	22
5.3.1	Get started	22
5.3.2	Module home page	26
5.3.3	Main Menu	28
5.3.4	Status menu	29
5.3.5	Basic and Advanced Configuration menus	34
5.4	SMS configuration	34
5.4.1	Creating the SMS	34
5.4.2	Sending the inbound SMS	36
5.4.3	Exiting from CONFIG mode	37
6	Maintenance and troubleshooting	38
6.1	Firmware updates	38
6.2	USB menu access disabled	40
6.3	LED status indicators	41
6.4	Firmware version LEDs	44
6.5	SIM card	44
6.6	Diagnostic log	44
6.7	Network polling	45
6.8	Control panel programming using cellular	45
6.9	RPS Diagnostics	45
7	Technical specification	46

1 Safety

ESD Precaution



Please note that while the module comes in a plastic case, and is protected from ESD, the plug-in cellular communicator (B44x) does not. All plug-in cellular communicator components may potentially be exposed to finger touches - therefore extra attention must be paid to ESD (electrostatic discharge) precaution.

Make sure there is no static interference when using the board. Appropriate ESD protections must be taken and wearing electrostatic equipment is recommended, such as anti-static wrist strap.

ESD damage ranges from subtle performance degradation to complete device failure. Precision integrated circuits may be more susceptible to damage because very small parametric changes could cause the device not to meet its published specifications.



Warning!

Failure to follow these instructions can result in a failure to initiate alarm conditions. Bosch Security Systems, Inc. is not responsible for improperly installed, tested, or maintained devices. Follow these instructions to avoid personal injury and damage to the equipment.



Notice!

Inform the operator and the local authority having jurisdiction (AHJ) before installing the module in an existing system.

Disconnect all power to the control panel before installing the module.

Before you install the module, refer to the technical specifications.

2 Introduction

This document contains instructions for a trained installer to install, configure, and operate this module.

2.1 About documentation

Copyright

This document is the intellectual property of Bosch Security Systems, Inc. and is protected by copyright. All rights reserved.

Trademarks

All hardware and software product names used in this document are likely to be registered trademarks and must be treated accordingly.

2.2 Bosch Security Systems, Inc. product manufacturing dates

Use the serial number located on the product label and refer to the Bosch Security Systems, Inc. website at <http://www.boschsecurity.com/datecodes/>.

2.3 Installation workflow

To install and configure the module, use the workflow below.

**Caution!**

Remove all power (AC and battery) before making any connections. Failure to do so might result in personal injury and/or equipment damage.

- Plan the installation of the module.
- Unpack the device contents.
- Power down the system.
- Set the bus address value to automatically configure the module to work with a compatible control panel. Refer to *Bus address settings, page 9*.
- Insert a plug-in communicator into the module. Refer to *Inserting a plug-in cellular module (required), page 12*.
- Mount the module into the enclosure. Refer to *Mounting the module, page 13*.
- Wire the module to a compatible control panel. Refer to *Connecting the module to the control panel, page 15*.
- Power up the system.
- Install a communication program (if required). Refer to *Get started, page 22*.
- Configure the communication module (SDI and option bus control panels).
- Verify LED activity. Refer to *LED status indicators, page 41*.
- Review the signal strength of the cellular communicator. Refer to the installation instructions for cellular communicator.

3 System overview

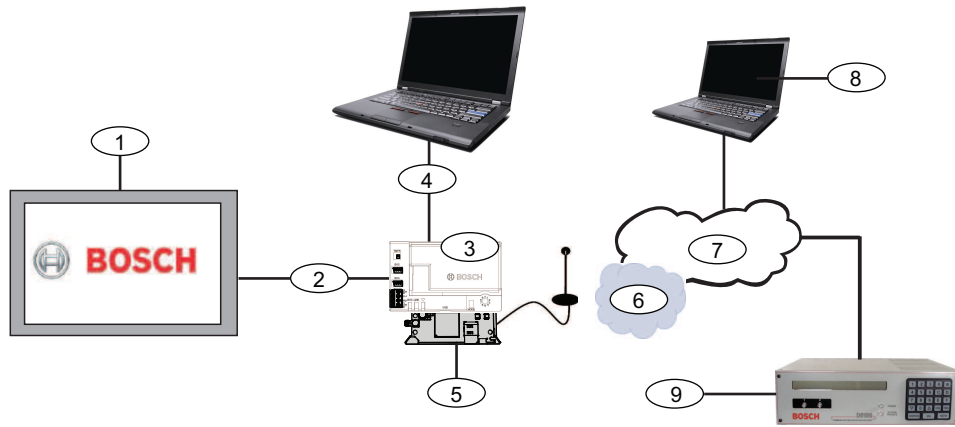

Callout - Description	Callout - Description
1 - Compatible control panel	6 - Cellular carrier network
2 - Panel data bus (SDI2, SDI, or option)	7 - Internet/LAN/WAN
3 - Module	8 - Remote Programming workstation
4 - USB connection for module configuration	9 - Compatible IP receiver (Bosch D6100IPv6 shown)
5 - B44x plug-in communicator (available separately)	

3.1 Module overview

The module is a four-wire powered SDI, SDI2, or option bus device that provides two-way communication over commercial cellular networks using a plug-in communicator.

To configure the module, use one of the following tools:

- *Plug and Play (PnP) configuration, page 21* (SDI2 and some option bus control panels)
- *USB configuration, page 22* (all control panels)
- *SMS configuration, page 34* (all control panels)

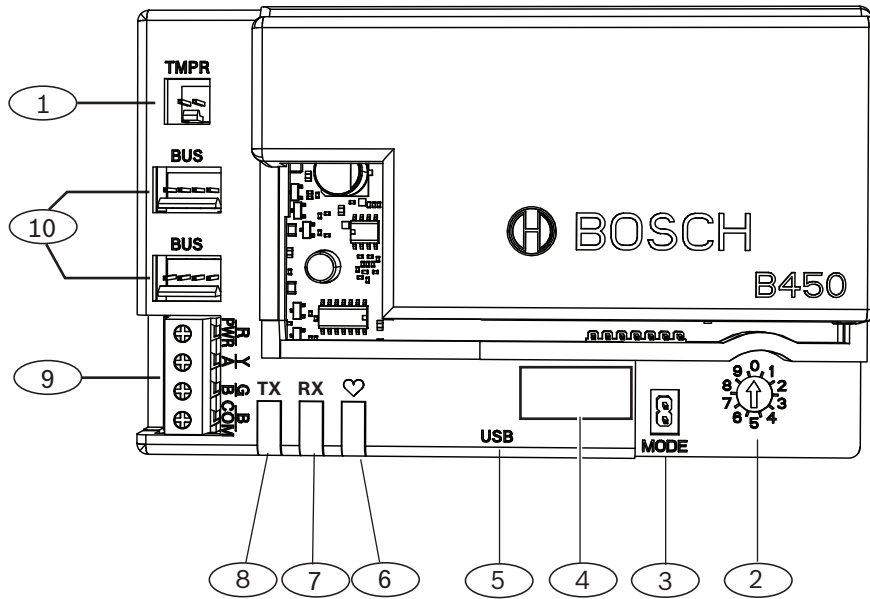

Callout - Description
1 - Tamper switch connector
2 - Bus address switch
3 - MODE 2-pin jumper connector (for future use)
4 - Bus address label
5 - USB connector (Type A)
6 - Heartbeat LED
7 - RX LED (indicates packets received from the wireless network)
8 - TX LED (indicates packets transmitted over the wireless network)
9 - Terminal strip (to control panel)
10 - Interconnect wiring connectors (to control panel or other compatible modules)

3.2 Cellular interface compatibility

The module supports multiple bus types. Refer to the table to determine the supported applications and features by bus type.

Function	Installed Bus		Details
	Option/SDI	SDI2	
IP event reporting	Y	Y	TCP communication is supported on SDI2 only
Remote programming software (RPS or A-link)	Y	Y	Requires Bosch Cellular service or other cellular network access

	Installed Bus		
*Configure module from control panel	N	Y	GV4/B Series require v2.03+, AMAX 2100/3000/4000
Personal notification via SMS or e-mail	N	Y	Requires compatible control panel and cellular plan
Remote Security Control App	N	Y	Requires Bosch Cellular service or other cellular network access
*AMAX 2100/3000/4000 option bus control panels must have firmware version 1.5 or higher to configure the module using A-Link Plus.			

The module also supports multiple cellular networks through the use of Bosch cellular communication modules. Refer to the following table to determine the supported Bosch cellular module and corresponding cellular network technology.

Cellular technology compatibility

Device	Cellular networks				
	2G (CDMA)	3G (CDMA)	GPRS (GSM)	HSPA+ (GSM)	4G (LTE)
B440/B440-C*	X	X			
B441/B441-C*	X				
B442*			X		
B443*			X	X	
B444*					X
*Check for availability in your region.					

3.3 Bus address settings

The control panel uses the address for communications. Use the address switch to set the bus type and the module address on the bus. Use a slotted screwdriver. Refer to the address label on the module and the following table to choose the address switch for the control panel type.

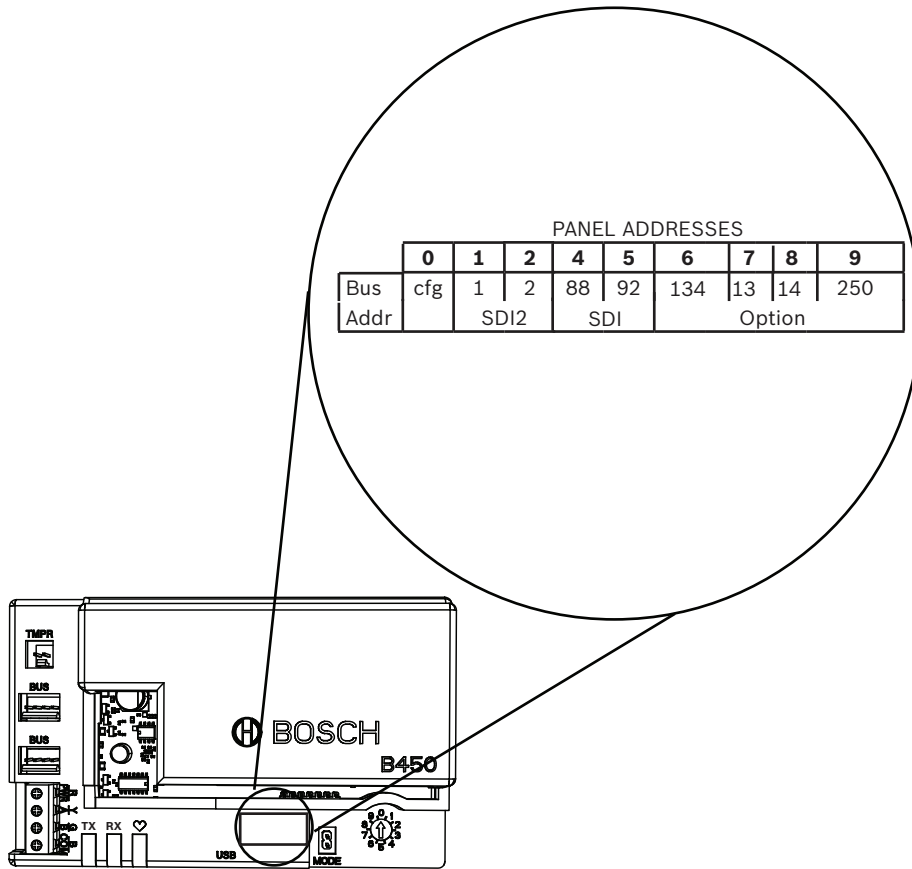

Control panels	Switch position	Control panel bus address	Bus type	Function
USB or SMS configuration setting	0	N/A	Any	Change configuration
B9512G/B8512G/B6512/ B6512/B5512/B4512/ B3512, D9412GV4/ D7412GV4/D7212GV4 Solution 2000/3000	1	1	SDI2	Automation, Remote Programming, Reporting
B9512G/B8512G/ D9412GV4/D7412GV4/ D7212GV4 Solution 2000/3000	2	2		Automation, Remote Programming, Reporting
D9412GV4/D7412GV4/ D7212GV4, D9412GV3/ D7412GV3/D7212GV3, D9412GV2/D7412GV2/ D7212GV2 (v7.06+)	4	88	SDI ¹	Remote Programming, Reporting
D9412GV4/D7412GV4/ D7212GV4, D9412GV3/ D7412GV3/D7212GV3	5	92		Remote Programming, Reporting

Control panels	Switch position	Control panel bus address	Bus type	Function
AMAX 2000/2100/3000/4000	6	134	Option	Remote Programming, Reporting
CMS 6/8, CMS 40	6	134		Remote Programming, Reporting
Easy Series (v3+) FPD-7024 (v1.06+) ²	6	134		Remote Programming, Reporting
FPD-7024 ²	9	250		Remote Programming, Reporting
<p>¹For D9412GV4/D7412GV4/D7212GV4 configurations, SDI2 bus connection is the recommended configuration option, but SDI bus configuration is also supported.</p> <p>²The FPD-7024 must be at firmware version 1.06 or greater in order to configure using bus address 134.</p>				

4 Installation



Caution!

Remove all power (AC and battery) before making any connections. Failure to do so might result in personal injury and/or equipment damage.

4.1 Inserting a plug-in cellular module (required)



Notice!

SIM cards

Some plug-in cellular modules require that you install a SIM card first. If the B44x you install does not require one, do not perform that step.



Notice!

Correct installation

Push the plug-in cellular module into the plug-in communicator interface until the module “clicks” into position.

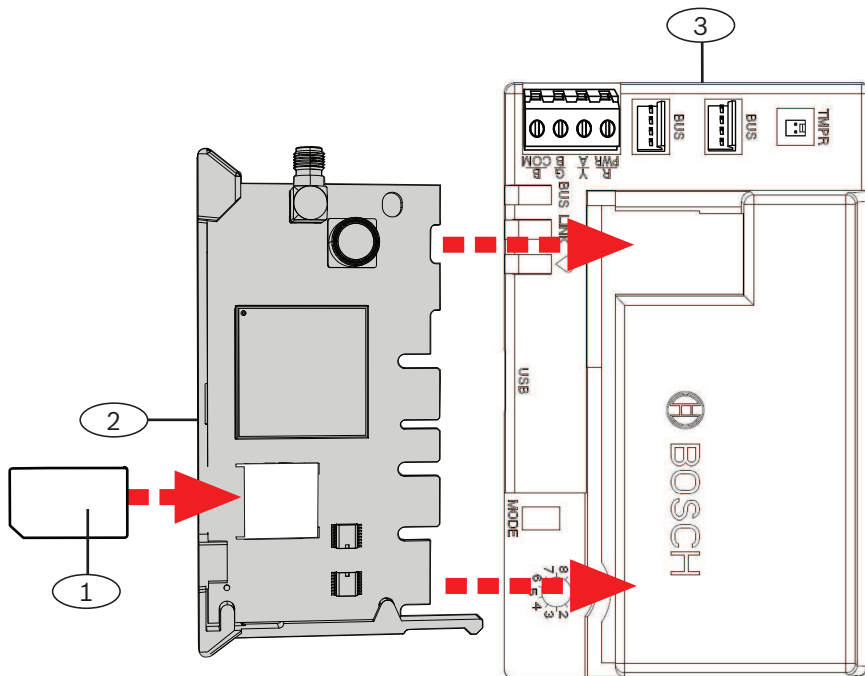

Callout - Description
1 - SIM card (required for some cellular modules, available separately)
2 - B44x plug-in cellular module (available separately)
3 - Module

4.2 Mounting the module



Notice!

Regulatory requirements

Mount the module in the control panel enclosure, or in a UL listed enclosure. For Commercial Burglary applications, house all communicators in tampered enclosures.

All communicators shall be housed in tampered enclosures. If the unit is used in a commercial burglar environment, and is enclosed in a commercial enclosure, that enclosure must be tampered.

If the installation is a local or police station connection, then the module must be mounted inside an attack resistant enclosure.



Notice!

Wiring considerations

If you use terminal strip wiring instead of interconnect wiring, wire the module to the compatible control panel before you mount it into the enclosure to make the installation easier.



Notice!

Installation considerations

Choose from the following mounting options before you mount the module:

Install the module on the inside enclosure wall that also contains the supported control panel. The control panel powers the module through the terminal block or bus connection.

Install the module on the inside wall of a separate enclosure. The control panel in a nearby, separate enclosure powers the module through the terminal block or bus connection.

Install the module on the inside wall of a separate enclosure that also has a separate external power supply such as the B520 Auxiliary Power Supply Module.



1. Hold the module mounting brackets on the inside of the enclosure. Match the bracket holes to a 3-hole mounting pattern on the enclosure
2. Put the supplied mounting screws through the holes and into the mounting bracket.
3. Tighten the screws.

4.3 Installing the tamper switch (optional)



Notice!

Dual tamper switch for compatible control panels

For control panels that are compatible with an enclosure tamper switch, you can use this module to connect and monitor the tamper switch.

1. Install the ICP-EZTS tamper switch. Use the instructions in the switch installation manual (P/N: F01U003734).
2. Connect the wire of the installed tamper switch wire to the tamper switch connector on the module.

4.4 Installing the cellular antenna

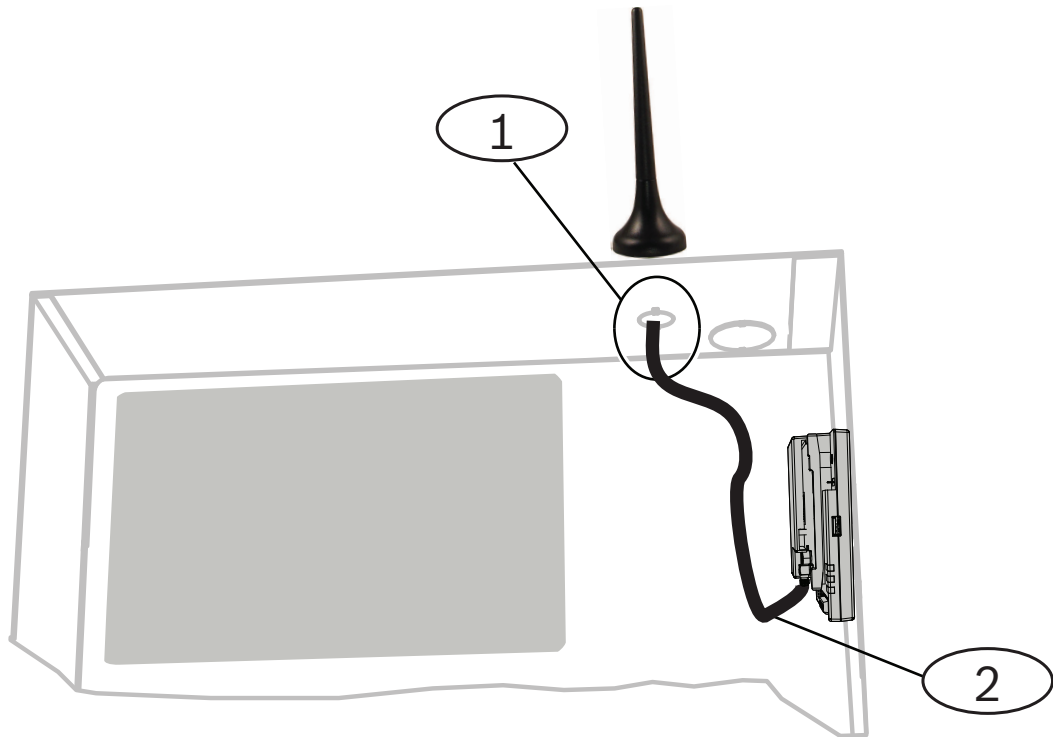

Callout — Description

1 — Plug-in cellular module antenna (routed through any knockout)

2 — Antenna cable

1. Place the magnetic antenna on top of the enclosure, or vertically on another metal surface.



Notice!

Best performance

If the module has a weak signal, position the antenna on top of a metal surface that has a radius of 10.16 cm (4 in).

2. Route the antenna cable through a knockout in the enclosure wall.
3. Connect the antenna cable to the module.
4. Secure the antenna cable to the inside of the enclosure.
5. Secure the extra antenna cable length inside the enclosure.

4.5 Connecting the module to the control panel



Caution!

Remove all power (AC and battery) before making any connections. Failure to do so might result in personal injury and/or equipment damage.

Use the instructions in this section for your control panel type. For complete wiring instructions, refer to the control panel documentation.

4.5.1 Connecting to SDI2 and SDI control panels



Notice!

Use either the terminal strip wiring **or** interconnect wiring to the control panel. Do not use both. When connecting multiple modules, you can combine terminal strip and interconnect wiring connectors in series.



Notice!

Combination SDI2/SDI control panels

For combination control panels, use the SDI2 terminals.

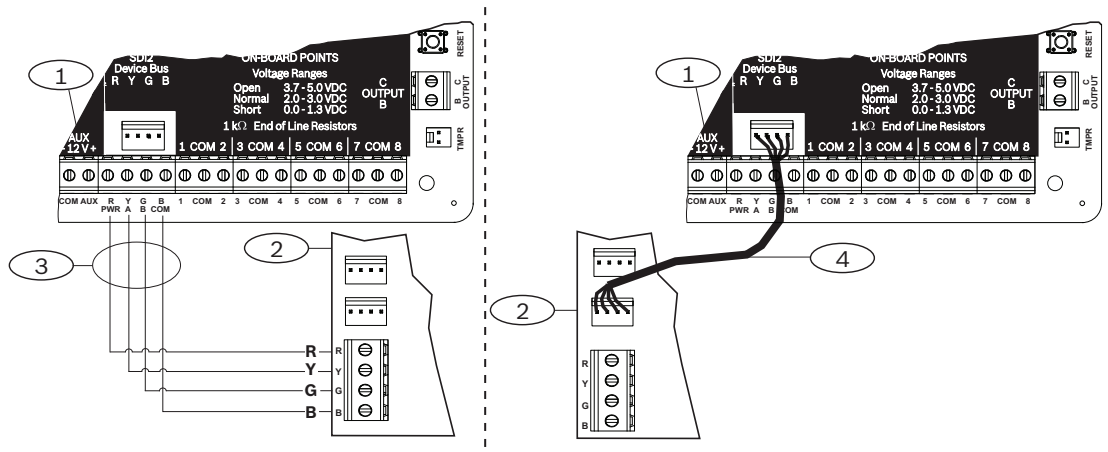

Callout — Description
1 — Compatible SDI2 control panel (B6512 shown)
2 — Module
3 — Terminal strip wiring
4 — Interconnect cable

4.5.2 Connecting to option bus control panels



Notice!

When you wire the module to the option bus terminal strip on the control panel, verify the terminal position of the wires. Option bus terminals might differ from module terminals. (For example, option bus = R, B, G, and Y) and (module = R, Y, G, and B.)

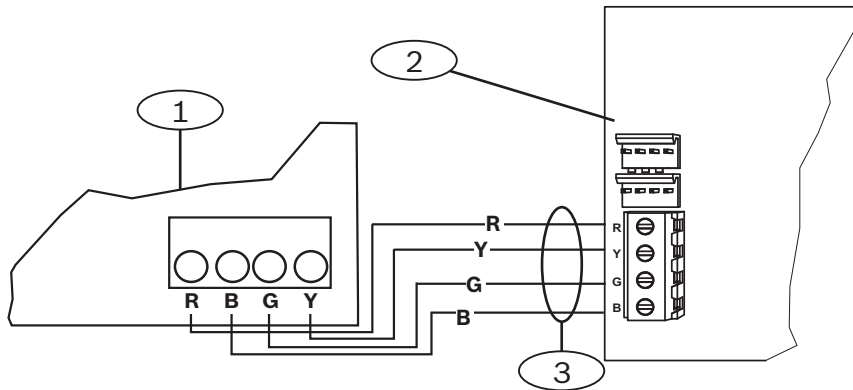

Callout — Description
1 — Compatible control panel (FPD-7024 control panel shown)
2 — Module
3 — Terminal strip wiring

5 Configuration

Configure the module using one of the methods described in this section. Not all options work for all control panel types.

- *Plug and Play (PnP) configuration, page 21* (SDI2 and some option bus control panels)
- *USB configuration, page 22* (all control panels)
- *SMS configuration, page 34* (all control panels)

5.1 Configuration parameters

Use this information to program a control panel for PnP, for USB configuration, or for SMS configuration. In this section, the parameters are listed in the order you see them in the USB menus. Not all parameters are available in all configuration programs.

(USB menu [3] Basic Configuration)

TCP/UDP Port Number

Default: 7700

Selections: 0 - 65535

For IP communications with RPS, automation, or Remote Security Control (RSC) in typical installations, keep the TCP/UDP Port at the default

AES Encryption

Default: No Encryption

Selections:

- No Encryption
- 128 bits - 16 bytes
- 192-bit - 24 bytes
- 256-bit - 32 bytes

Select the AES key size.

Module Enclosure Tamper

Default: No - Disable

Selections:

- Yes - enable enclosure tamper input
- No - disable enclosure tamper input

When the tamper input is enabled and connected to a Bosch ICP-EZTS tamper switch, the control panel creates a tamper event when the enclosure door is opened, or when the enclosure is removed from the wall.

Panel Programming Enable

Default: Yes

Selections: Yes, No

Yes - Control panel programming is enabled.

No - Control panel programming is disabled.



Notice!

Do not disable

Do **not** disable panel programming unless you use an SDI2 control panel or AMAX 2100/3000/4000 with Panel Programming Enable enabled. Do **not** disable Web Access Enable and Panel Programming Enable.

Inbound SMS

Default: Yes

Selections:

- Enabled (Yes) - you can use inbound SMS text messages to configure the module.
- Disabled (No) - the module does not process inbound SMS text messages.

Reporting Delay for Low Signal Strength (sec.)

Default: 0 (disabled)

Selections: 0 (disabled), 1 - 3600 (seconds)

Time of low signal strength (red LED on cellular communicator) before the control panel makes a Cellular Low Signal event.

Network Access Point Name (APN)

Default: eaaa.bosch.vzwentp

Selections: 0-9, A-Z, a-z, -, :, . (up to 99 characters)

Enter up to 99 characters for the network access point name (APN). The APN is case sensitive.

Network Access Point User Name

Default: Blank

Selections: ASCII characters (up to 30)

Enter up to 30 ASCII characters for the Network Access Point user name.
The user name is case sensitive.

Network Access Point Password

Default: Blank

Selections: ASCII characters (up to 30 characters)

Enter up to 30 ASCII characters for the Network Access Point password.
The password is case sensitive.

SIM PIN

Default: Blank

Selections: 0-9 (minimum 4 digits, maximum 8 digits)

Use this parameter only when a PIN is necessary for SIM cards.
If a SIM PIN is not necessary, leave the field blank.

Session Keep Alive Period (min)

Default: 0

Selections: 0 to 1,000

This parameter sets the length of time in minutes between session keep alive reports to verify that an idle connection is still active. Keep the default value.

Inactivity Timeout (min)

Default: 0

Selections: 0 (disable) to 1000 (minutes)

- 0 (disabled) - panel does not monitor for data traffic.
- 1 to 1000 - the time with no data traffic before the control panel ends a session.

Only change from default for high security UL 1610 commercial listed installations requiring low signal notification.

Email Server Name/Address

Default: Blank

Selections: Domain name or IP address

Enter either the domain name or address for the SMTP (Simple Mail Transfer Protocol) email server for your chosen provider.

Email Server Port Number

Default: 25

Selections: 1-65535

Port 25 is the default SMTP port for most outgoing servers. If the IP denies the default port number (generally because of the massive spam and malware traffic), try another commonly used port such as port 587 or port 465 to avoid the block.

Email Server Authentication/Encryption

Default: Authenticate

Selections:

Basic - no authentication, no encryption

Authenticate - authentication required, no encryption

Encrypted - authentication required, encryption required

Select the security level required by the email server to receive messages from the control panel.

Authentication User Name

Default: Blank

Selections: Blank, 1 to 255 characters

Enter the user name for the email account receiving personal notification email sent by the control panel.

Authentication Password

Default: Blank

Selections: Blank, 1 to 49 characters

Enter the password that the SMTP server uses to send emails to the Personal Notification destinations.

(USB menu [4] Advanced Configuration)**IPv4 DNS Server IP Address**

Default: 0.0.0.0

Selections: 0.0.0.0 to 255.255.255.255

A Domain Name Server (DNS) uses internet domain names or hostnames to supply corresponding IP addresses. In DHCP mode, the DHCP server's default DNS is used. To use a custom DNS server in DHCP mode, enter the custom DNS server's IP address here.

Alternate IPv4 DNS Server IP Address

Default: 0.0.0.0

Selections: 0.0.0.0 to 255.255.255.255

If the IP communicator fails to get an address from the primary server, it tries the alternate DNS server. Enter the IP address for the alternate IPv4 DNS server.

Modem Reset Count

Default: 5

Selections: 0 to 99

This parameter sets the number of times a data packet must be sent without a reply before the cellular module modem resets.

When connected to an SDI2 control panel v2.03 or higher, the default is zero and controlled by the above mentioned control panel, unless control panel programming is disabled.

Web/USB access enable

Default: No

Selections: Yes/No

This parameter enables authorized users to view and modify the module configuration parameters through a standard web browser or USB, depending on available options.



Notice!

Do not disable for some control panels

Do **not** disable USB access unless you are on an SDI2 control panel or AMAX 2100/ 3000/ 4000 with Panel Programming Enable enabled. With SDI and other option control panels, you must use the USB interface.

Web Access Password

Default: B42V2

Selections: blank, ASCII printable characters

This parameter sets the password required to log in for web access.

The password must be 4-10 ASCII printable characters in length. Blank spaces disable the password checking.

TCP Keep Alive Time

Default: 45

Selections: 0 - 65 (seconds)

Time in seconds between TCP keep-alive messages. Keep alive messages make sure that a connection stays active.

Reporting Delay for No Towers (sec)

Default: 0

Selections: 0 (disabled) - 3600 (seconds)

When the cellular plug-in module senses no towers for the seconds set by this parameter, the control panel records a No Towers event and a No IP Address event.

The control panel records a No Tower restoral event when the cellular plug-in module senses one or more towers for the seconds set by this parameter.

The control panel records a No IP Address restoral event when the cellular plug-in module registers with one or more towers and receives an IP address within 60 seconds.

Reporting Delay for Single Tower (sec)

Default: 1800

Selections: 0 (disabled) - 3600 (seconds)

Keep this parameter at the default setting unless instructed by a Bosch Security Systems, Inc. representative.

When the cellular plug-in module senses only one tower for the seconds set at this parameter, the control panel records a Single Tower event.

When the cellular communicator senses two or more towers for the seconds set at this parameter, the control panel records a Single Tower restoral event.

TCP Keepalive Time (sec)

Default: 0

Selections: 0 (disabled) to 1000 (minutes)

Time in minutes between keep-alive messages. Keep alive messages make sure that a connection stays active.

Only change from default for high security UL1610 commercial listed installations.

5.2

Plug and Play (PnP) configuration

With PnP, the module automatically imports the control panel settings for the module and applies them to the module.

You can use this feature for the following control panels:

- AMAX 3000/4000 firmware version v1.5 or higher
- B9512G/B9512G-E
- B8512G/B8512G-E
- B6512
- B5512/B5512E
- B4512/B4512E
- B3512/B3512E
- D9412GV4/D7412GV4/D7212GV4
- Solution 2000/3000 firmware version v2.0 or higher

To disable this feature for PnP control panels, disable the Panel Programming Enable parameter before you connect the module.



Notice!

By default, when you connect a field replacement module to an existing SDI2 or option bus control panel, the control panel overrides the module settings (PnP). To keep the current settings for the new module, use USB configuration to disable Panel Programming Enable.

Using PnP

1. Program the control panel configuration for the module. Use RPS, or A-Link, or a keypad.
2. Send the programming to the control panel.
3. Set the address switch for the control panel (SDI2 control panels use address 1 or 2, option bus control panels use address 134 or 250).
4. Connect the module to the control panel bus.
5. Apply power to the control panel.

The module imports the settings and then programs the connected module.

5.2.1

RPS configuration

For control panels that support RPS configuration, you can program the control panel to configure the module with PnP.

For configuration parameters, refer to *Configuration parameters, page 17*.

You can also refer to the *RPS Help*.

Use the following sections in RPS:

- *SDI2 Modules > IP Communicator*
- *SDI2 Modules > IP Communicator > B450 Cellular** (For D9412GV4/D7412GV4/D7212GV4 v1.xx, use the *B420 Ethernet Communicator* section.)

***B450 Cellular**

For SDI2 control panels using firmware v2.03+, you can use RPS v5.19+ to configure GSM cellular parameters for the B442 and B443. Refer to RPS and RPS Help for information on these parameters.

Use RPS settings on Module 1 only. For a second B450 module, you must use the USB menu. For SDI2 control panels using firmware version v1.00 to v2.02, use the USB interface connected to the B450.

5.3 USB configuration

For configurations that are not PnP, you can connect a computer directly to the module with USB. To configure the module, install the USB driver and Tera Term on the connected computer. The B450 CD-ROM has the RBUS1CP.inf (USB driver) and Tera Term installation files.

**Notice!****RPS users**

You can use RPS v5.16 or higher to configure the module through a remote connection to the control panel, or with a USB connection to the control panel. Refer to *RPS configuration, page 21*.

**Notice!****Male A to Male A cable required**

USB configuration requires a Male A to Male A cable. Bosch recommends the B99 cable (P/N: F01U278853).

Use the USB connection for configuration or diagnostics only. Disconnect the cable when not in use.

Getting the USB driver and Tera Term

If you do not have the B450 CD-ROM, download the required files from www.boschsecurity.com. Go to the B450, then to the Software Downloads tab. Click the link for the driver and Tera Term. Save the file to the computer. This applies to the B450 only.

5.3.1 Get started

Installing the RBUS1CP.inf file USB driver

1. Install the RBUS1CP.inf file onto the connected computer.
2. Open Device Manager to make sure that the INF file installed and shows in the Ports (COMM & LPT) section.

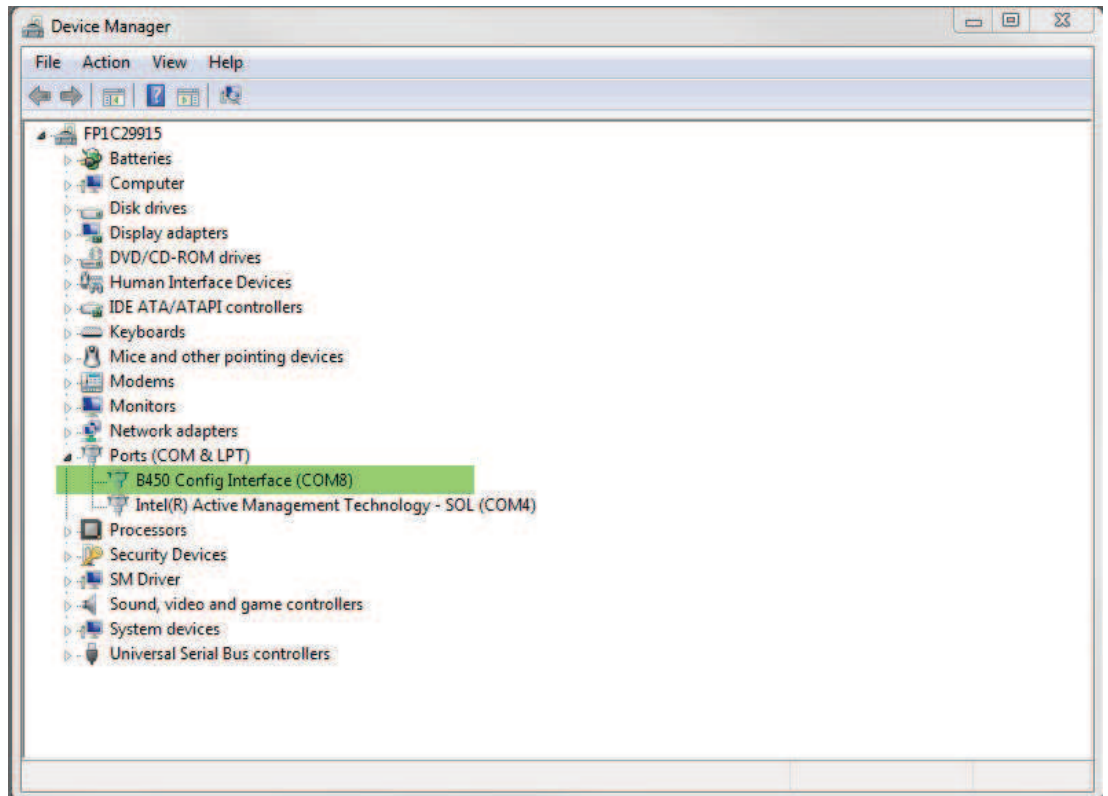

Installing Tera Term

1. On the connected computer, navigate to the Tera Term file from the CD-ROM or zip downloaded from the website.
2. Follow the prompts in the installation wizard until the Select Components page of the wizard. Select Compact installation from the drop-down list.

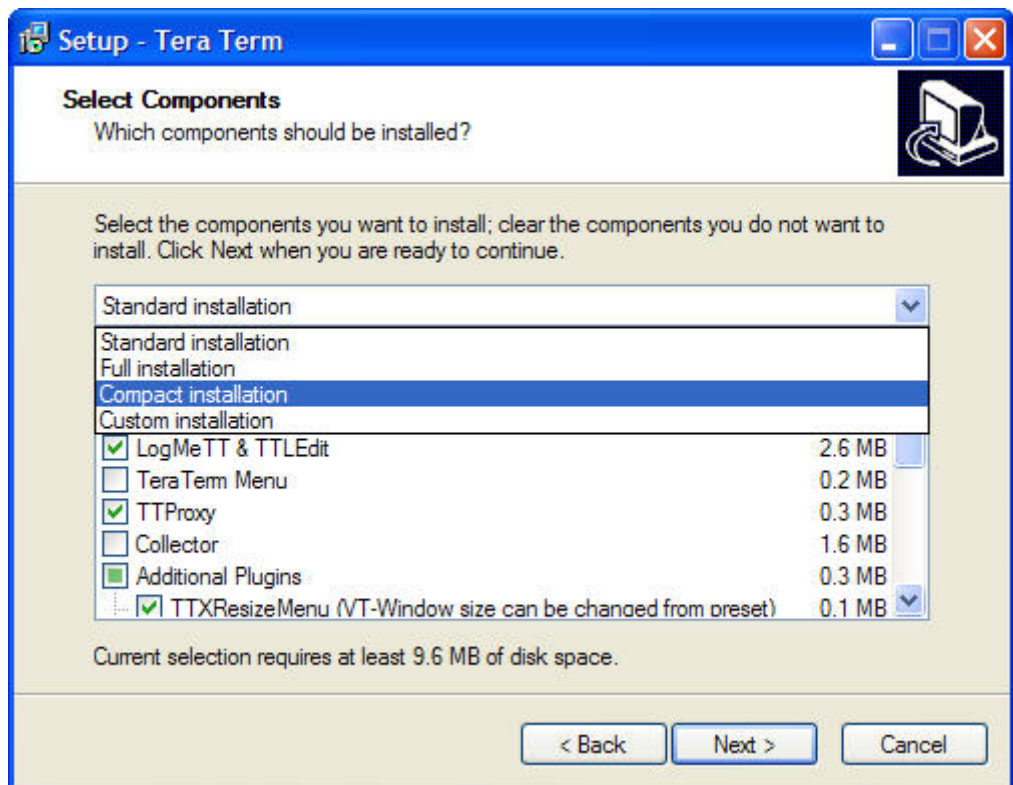

3. Follow the remaining prompts.

Configuring the Tera Term interface

1. Open Tera Term. The Tera Term window opens.

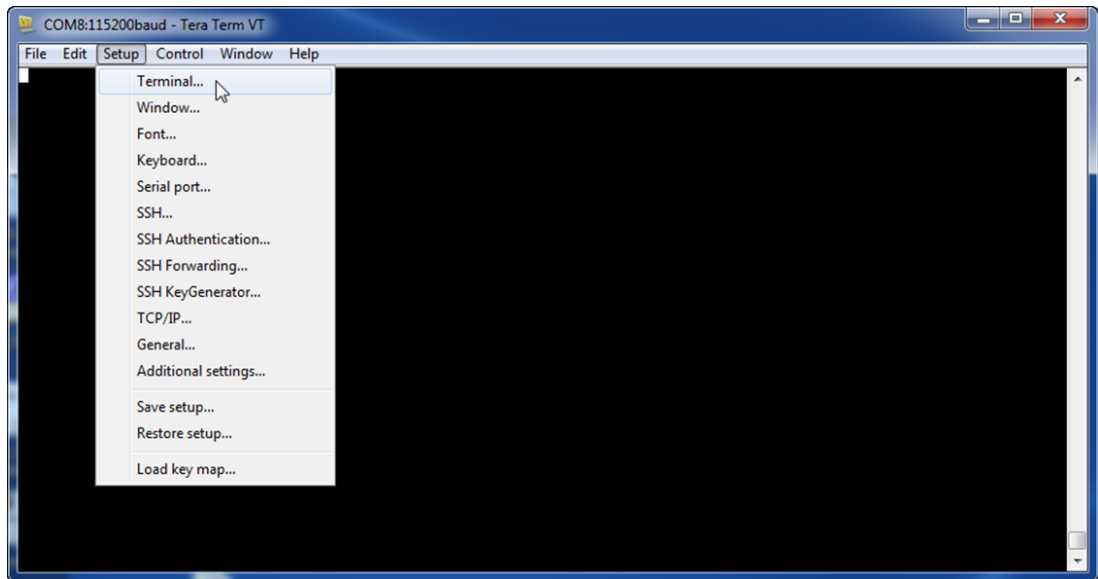

2. From the menu bar, select Setup > Terminal. The Terminal Setup window opens.

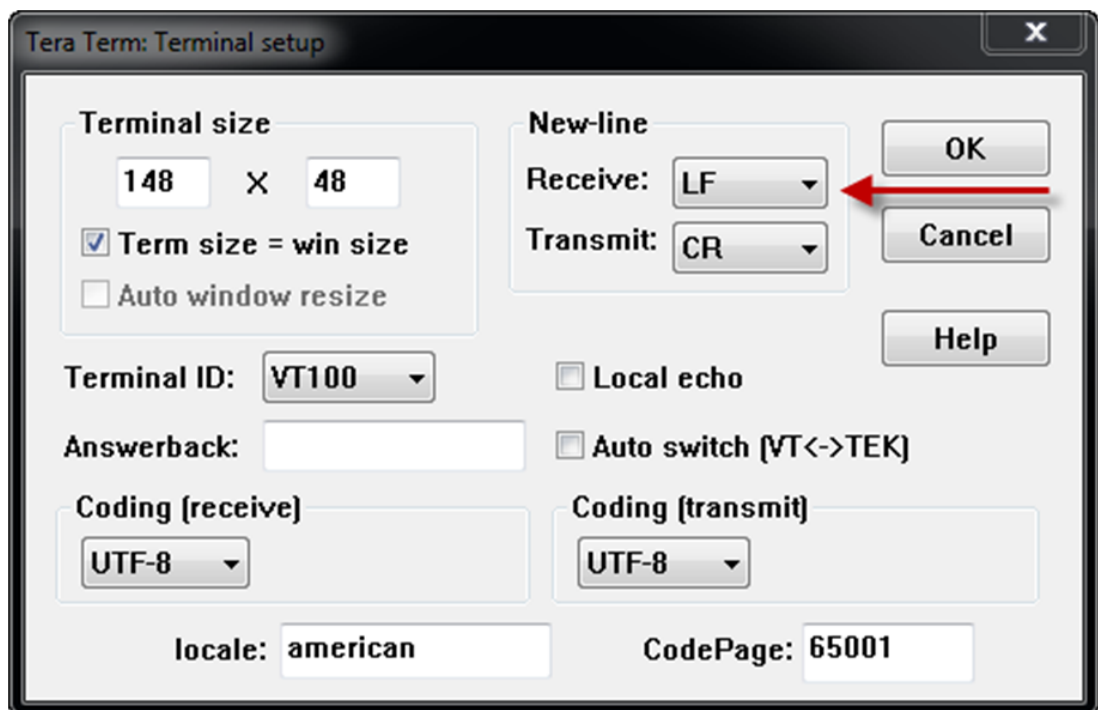

3. In the New-line section, select LF from the Receive drop-down list. Click OK.
4. From the menu bar, select Setup > Save Setup. A dialog box appears.
5. Click Save to overwrite the existing TERATERM.INI file. Tera Term stores the new setting for future Tera Term sessions.

Logging into the module

1. Connect the USB cable to the module.
2. Connect the USB cable to the computer.
3. Open Tera Term. The New connection dialog box opens.

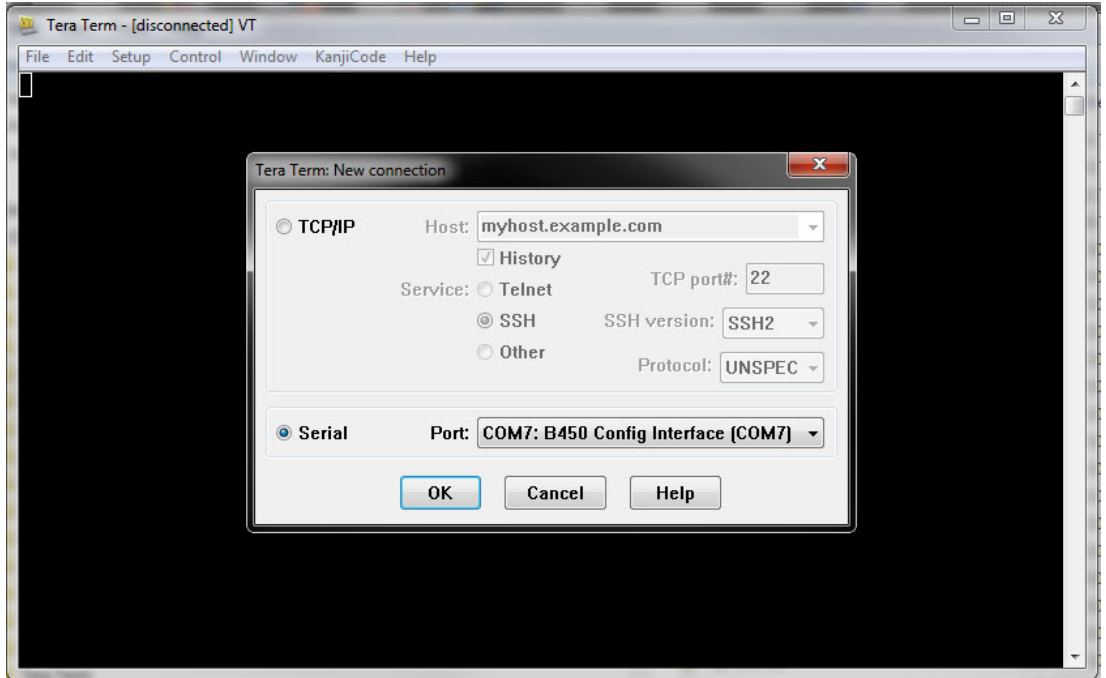

- 4. From the Serial Port drop-down list, select the module (for example, Port: COM7: B450 [COM7]).
- 5. Click OK. Tera Term connects.
- 6. Press [Enter]. A windows appears with a request to enter the passcode.

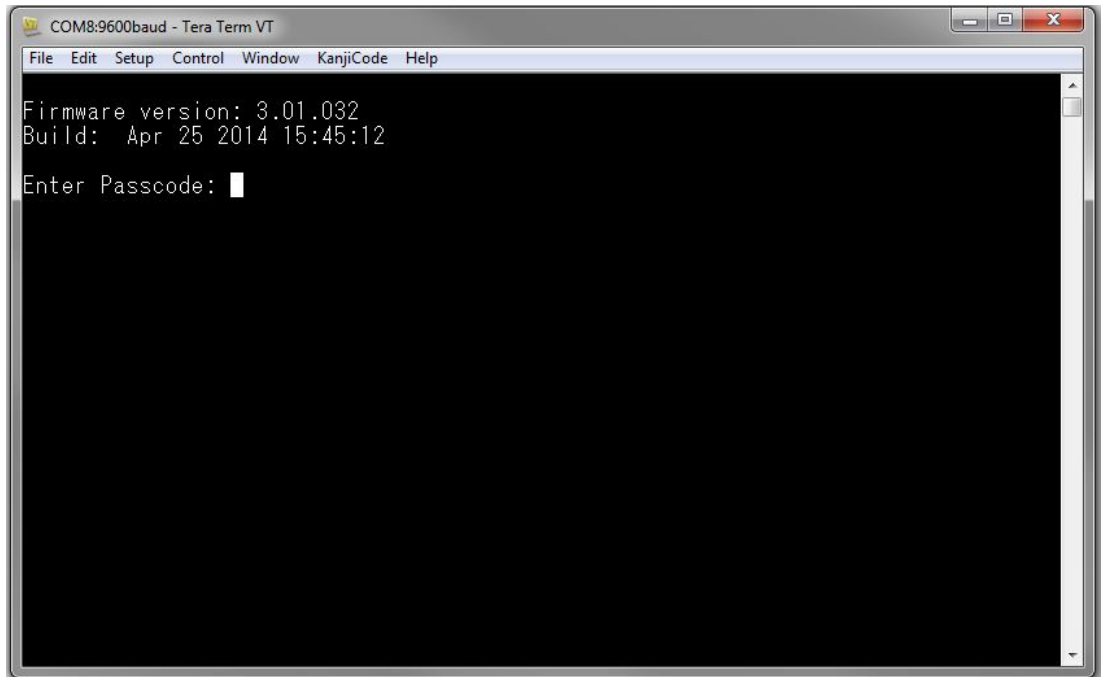

- 7. Enter the password (default is B450) and press [Enter]. The USB main page opens.



Notice!

Log in troubleshooting

The default password is case-sensitive. Verify the password for case-sensitivity when entering.

The user interface allows three attempts to enter the password correctly. After three failed attempts, Tera Term shows a Too many attempts error message, and is idle for 30 seconds. If Tera Term shows a Menu access disabled error message, refer to *USB menu access disabled*, page 40.

5.3.2

Module home page

The module home page in Tera Term opens when you do one of the following:

- Log in.
- Press [Enter] before you enter a number for a menu (for example, 3 for Basic Configuration).
- Exit a menu.

The home page includes four important sections.

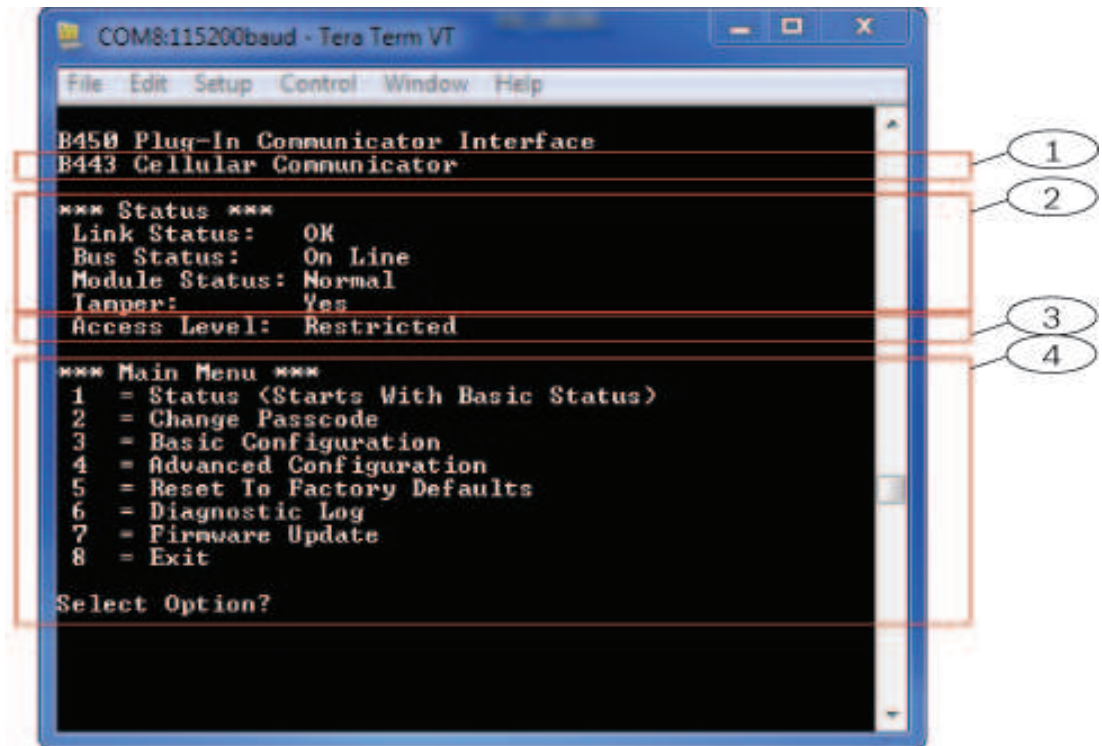

Callout	Description
1	Plug-in cellular module
2	Plug-in status
3	Current access level
4	Main menu options

Plug-in cellular module overview

This field shows one of the following about the communicator:

- Module number of the communicator (for example, B443 Cellular Communicator)
- Plug-in not connected
- Detecting plug-in module

Plug-in status overview

This section has 4 fields with status.

- Link Status. The connection status to the cellular network is OK or Error.
- Bus Status. The bus status is On Line or Not Connected.
- Module Status. The module status is Normal or Trouble.
- Tamper. The status of the tamper switch connection is Yes, No, or Disabled (through configuration).

Access level overview

The access level for the module is Restricted or Full.

Main Menu overview

Refer to *Main Menu*, page 28.

5.3.3

Main Menu

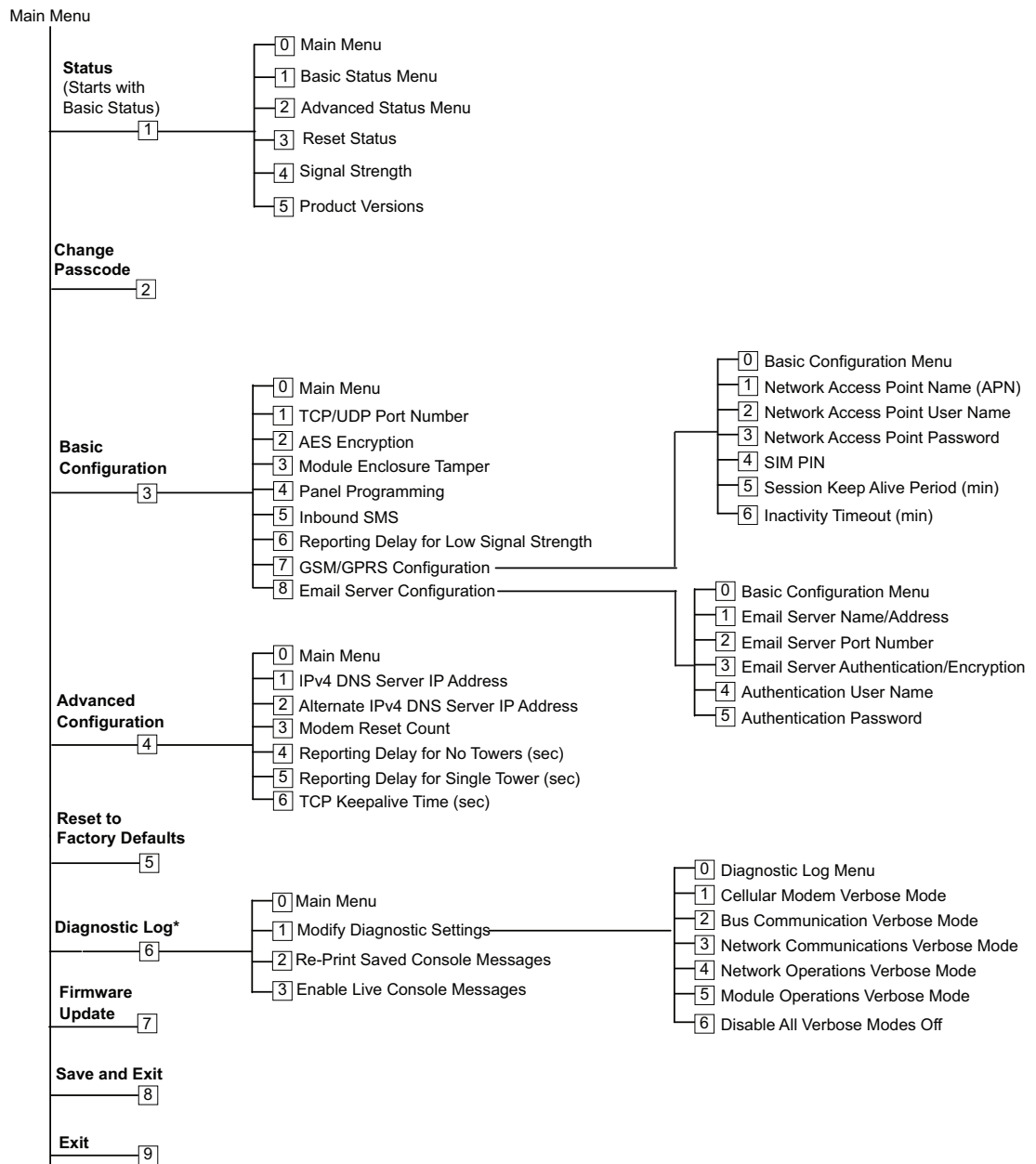

*The Diagnostic Log option is used in troubleshooting communication issues with the module. Only use the Diagnostic Log option if told to do by Bosch technical support.

Main Menu important tips

- To open a menu, press the number key for the menu. For example, press [1] to open the menu for 1 Status (Starts with Basic Status).
- To make sure all changes are saved, use **[8] Save and Exit**.
- To return to the previous menu if you did not make programming changes, press [Esc].
- To cancel the changes you make, press [Esc].

**Notice!**

Unsaved changes are lost if you do not press a key within 5 minutes. Tera Term automatically logs out of the module.

Main Menu options overview

Option	Description
1. Status (Starts with Basic Status)	Shows the link, modem, and bus status
2. Change Passcode	Use to change the login passcode, enter the new passcode twice. The second entry confirms the new passcode. Passcodes must be 4 to 10 characters long, and are case-sensitive. 0-9, A-Z, a-z, and special characters are allowed. Notice! If SMS configuration is used, do not use semicolon (;) or exclamation mark (!) as part of the passcode.
3. Basic Configuration	Use to program Basic Configuration options. Press 0 to return to the Main menu. To change a basic parameter, select the option to change, and then enter in the new value.
4. Advanced Configuration	Use to program advanced options. Press 0 to return to the Main Menu. To change an advanced parameter, select the option to change, and then enter in the new value.
5. Reset to Factory Defaults	Use to reset all factory default values. All fields are cleared and the factory default values are restored. Notice! A non-defaulted SDI2 control panel overwrites the default settings if connected to the defaulted module.
6. Diagnostic Log	The Diagnostic Log option is used to troubleshoot communication problems. Only use of the Diagnostic Log option at the direction of Bosch Technical Support. For more information, refer to <i>Diagnostic log</i> , page 44.
7. Firmware Update	Use to update the module firmware. For more information refer to <i>Firmware updates</i> , page 38.
8. Exit	Select to exit the menu and log out. You must enter the passcode to log back in. Notice! If you make configuration changes but do not save the changes, Tera Term prompts you.

5.3.4**Status menu****Basic Status menu overview**

The following section describes the Status menu parameters.

```

*** Link Status ***
IP Address: 10.33.0.44
Link Status: OK
Encryption: Disabled
Socket 1: Port Number 7700 UDP
Socket 2: Port Number 7700 TCP

*** Modem Status ***
Telephone Number: 315-576-8637
Electronic Serial #: A1000032B337E1
Modem Status: Connected
Signal Strength: Very Good

*** Bus Status ***
Bus Type: SDI2
Bus Address: 1
Bus Voltage: Good

*** Basic Status Menu ***
0 = Main Menu
1 = Basic Status Menu
2 = Advanced Status Menu
3 = Reset Status
4 = Signal Strength
5 = Product Versions

Select Option? █
    
```

Parameter	Description
Link Status	
IP Address	Shows the current Cellular Network IP Address. An IP address of 0.0.0.0 is listed when no IP address is found.
Link Status	Shows the connection status to the cellular network. Shows either OK, or Error.
Encryption	Shows either Normal, or Trouble:
Socket xx: Port Number	Shows the current open Port Numbers and Data Types (up to 32).
Modem Status. The information below shows in the appropriate fields. If no modem status is detected, the following message shows: Modem status is not available.	
Telephone Number	Shows the cellular phone number if available. A phone number of 000-000-0000 is listed when there is no phone number.
Electrical Serial # (ESN)	Shows the B44x radio modem serial number.
Data Status	Shows one of the following: Disconnected, Connecting, or Connected.

Signal Strength	Shows the current signal strength: Very good, Good, Marginal, Unacceptable, or Unavailable.
Bus Status	
Bus Type	Shows the current bus type: SDI2, SDI, Option, or None.
Bus Address	Shows the current bus address: 1, 2, 88, 92, 134, or 250.
Bus Voltage	Shows the current voltage: Good or Low.
<p>Module Status - This status shows only if there is a trouble condition.</p> <ul style="list-style-type: none"> - B44x Plug-in Missing - Detecting Plug-in <ul style="list-style-type: none"> - B44x Plug-in Missing - B44x Plug-in Invalid - No IP Address - Detecting Plug-in - Signal Strength Low (if configured) - Too Few Towers - No Towers (if configured) - B44x Not Active - B44x Failure - Configuration Failure - Low Bus Voltage - No Bus Communication - Switch in Position 0 - Firmware Checksum Error - Configuration Checksum Error - SIM Missing - SIM PIN Wrong - SIM PIN Lockout - Invalid Access Point - No IP Address 	

Advanced Status Menu

The following section describes the Advanced Status menu parameters.

```

*** Advanced Link Status ***
Internet: OK
Primary DNS Server Address: 198.224.186.135
Alternate DNS Server Address: 198.224.187.135
DNS Status: No status
UDP Packets Transmitted: 0
UDP Packets Received: 0

*** Advanced Modem Status ***
Transceiver Model #: DE910-DUAL
Carrier Name: Verizon
Signal Strength: -57 dbm
Towers Available: 1
Base Station ID: 4629
Frame Error rate: 999
Current Band: CDMA 800 MHz
Data Class: 3G
Temperature: 27C

*** Advanced Bus Status ***
Bus voltage: 13.65V
Bus commands received: 137684

*** Advanced Status Menu ***
0 = Main Menu
1 = Basic Status Menu
2 = Advanced Status Menu
3 = Reset Status
4 = Signal Strength
5 = Product Versions

Select Option? █
    
```

Parameter	Description
Advanced Link Status	
Internet (ping)	Shows one of the following: OK, Error, No Status (no ping has been performed).
IPv4 DNS Server IP Address	Shows the current IP address.
Alternate IPv4 DNS Server IP Address	Shows an alternate IP address.
DNS Status	Shows one of the following: OK, Error, No Status (no DNS lookup performed).
UDP Packets Transmitted	Shows from power up, or Option 3 (Reset Status)
UDP Packets Received	Shows from power up, or Option 3 (Reset Status)
Advanced Modem Status	

Transceiver Model number	Shows one of the following: DE910-DUAL, CE910-DUAL, GE910-QUAD
Carrier Name	Shows the carrier network providing service.
Data Status	Shows one of the following: Disconnected, Connecting, or Connected.
Signal Strength	Shows the current signal strength in dbm.
Towers Available	Shows the number of towers that can be detected by the module
Base Station ID	Shows information about the tower you are currently connected to.
Current Band	Shows the current band frequency
Data Class	Shows one of the following: 1xRTT, 3G, GPRS, EDGE, WCDMA, HSPA
Temperature	Shows the internal temperature of the radio transceiver (in Celsius)
Advanced Bus Status	
Bus Voltage	Shows the voltage measured at the input to the module
Bus Commands received	This is a running total of the number of valid bus messages that the module has received. If the module is on the bus and operating, this number changes when refreshed.

Status sub-menu

To open a sub-menu, from the **[1] Status (Starts With Basic Status)** menu, press the number key for the menu. For example, press [1] to open 1. Basic Status Menu.

Option	Description
1. Basic Status Menu	Shows the current IP address, link status, modem status, bus status, and module status.
2. Advanced Status Menu	Shows various parameters related to the cellular device such as UDP packets transmitted and received, the carrier name, available towers, and data class.
3. Reset Status	Shows several items that are counts of activities, such as UDP packets transmitted. When you select Reset Status, all counts return to zero.
4. Signal Strength	<p>The current signal strength records every 15 minutes for up to 48 hours worth of data. When you select Signal Strength, Tera Term shows up to 192 values that represent the signal strength over the last 48 hours. If the module has been powered up less than 48 hours, the list shows only the samples taken so far. If it has been less than 15 minutes, the menu shows “Not Available” listed.</p> <pre> *** Signal Strength History *** (Oldest value (dB) is printed first in 15 minute intervals.) -60 -56 -57 -56 -58 -58 -57 -59 -58 -59 -59 -60 -60 -64 -60 -61 -60 -63 -62 -60 -60 -60 -61 -61 -61 -60 -59 -61 -61 -60 -59 -61 -64 -60 -63 -60 -60 -60 -61 -58 -59 -59 -59 -60 -61 -59 -59 -60 -59 -59 -60 -59 -60 -59 -60 -59 -60 -60 -59 -63 -61 -60 -62 -61 -61 -59 -59 -61 -60 -58 -60 -58 -59 -59 -60 -59 -60 -61 -60 -60 -59 -60 -60 -59 -60 -62 -60 -57 -58 -58 -61 -58 </pre>
5. Product Versions	Shows the version information for the B450. For example: *** Product Versions ***

	B450 Product ID: 88096.16041400007 B450 Application: V 3.01.032 B450 Boot Loader: V 1.05.001 B450 Hardware: V 1.00.000 RTOS: V 3.03.600 Fusion Stack: V 8.07.5603 Cellular Manager: V 2.00.3203 UPKI Encryption: V 3.03.002 AES Lib: V 01.00.000 Modem Firmware: V 15.00.021
--	---

See also

- *Firmware updates, page 38*
- *Diagnostic log, page 44*

5.3.5**Basic and Advanced Configuration menus**

Use the figure in *Main Menu, page 28* to locate the configuration option you want to set. Enter the corresponding numbers to access the option. For example, press [3] [1] for [3] Basic Configuration > [1] TCP/UDP Port Number. Use the on-screen prompts to set the configuration.

For detailed information on the configuration options, refer to *Configuration parameters, page 17*.

USB Configuration important notes

- TCP/UDP Port Number Character limitations. Enter the 32 digit encryption key. Verify the 32 digit key does not exceed the arrow prompt, as shown in the figure above. Use only hex values 0-9 and A-F.
- SIM PIN. To erase text, you must type in the word None to erase the previous text. This is NOT case-sensitive.

See also

- *Configuration parameters, page 17*

5.4**SMS configuration**

The module supports configuration by SMS connection on a mobile phone or other device that sends SMS text messages. To use this feature, enable the *Inbound SMS* parameter.

The SMS string follows a specific format. If the configuration message exceeds 160 characters, you must send multiple messages. The module applies the configuration when it receives the final valid part of an SMS message.

Entering CONFIG mode

For the module to receive SMS messages, you must set the address switch to 0. With other addresses, the module discards incoming SMS.

For detailed information on the configuration options, refer to *Configuration parameters, page 17*.

5.4.1**Creating the SMS**

1. Use the SMS information in this section to write the SMS.
2. For SMS that need more than 160 characters, refer to *Multiple SMS messages, page 36*.

Before you begin

- Separate each ID or value pair with a semi-colon ; (for example, **%1;1=B450;19=1;!)**. To allow spanning of configuration across multiple messages, each SMS starts with the sequence number followed by the command line separator.
- Use the ! character to signal the end of the configuration data. Refer to your cellular phone documentation for available characters.
- Add the current SMS configuration passcode in the SMS text message to allow the module to save the new configuration data.
- The configuration message must begin with the sequence number (%1) and must include the current module configuration password (default = B450) followed by the ID number and the value you want to set.
- To remove text from an SMS message, use the word **None**, or ;. For example, if you want to remove a SIM PIN using SMS, enter either 4=None or 4=;. The word None is NOT case sensitive.

SMS configuration parameters

ID	Description
1=	Current passcode (4 to 10 characters); default = B450
2=	New passcode (4 to 10 characters)
4=	SIM PIN (4 to 8 characters)
Basic parameters	
10=	Network Access Point Name (APN): Text characters that can fit in a single text message
11=	Network Access Point User Name (up to 30 characters)
12=	Network Access Point Password (up to 30 characters)
13=	TCP/UDP port number: 7700 (1 to 65535)
15=	AES encryption <ul style="list-style-type: none"> - 0 = disable - 1 = 128 bit - 2 = 192 bit - 3 = 256 bit
16=	AES encryption key (0 to 9, A-F, a-f, based on key size, none, 32, 48, or 64 digits) Default = 0102030405060708091011121314151601020304050607080910111213141516
19=	Module Enclosure Tamper (V1.0.x control panels on SDI2 bus) <ul style="list-style-type: none"> - 0 = disable - 1 = enabled
20=	Inbound SMS <ul style="list-style-type: none"> - 0 = disabled - 1 = enabled
Advanced parameters	

ID	Description
57=	Session Keep Alive (0 to 1000 min)
58=	Inactivity timeout (0 to 1000 min)
65=	IPv4 DNS Server IP Address
66=	Alternate IPv4 DNS Server IP Address
67=	Panel programming - 0 = disabled - 1 = enabled
68=	Reporting delay for low signal strength (0 - 3600 sec)
69=	Reporting delay for no towers (0 - 3600 sec)
71=	Modem reset count (0 - 99)
72=	TCP keep alive time (0 - 255 sec)

Multiple SMS messages

Use multiple SMS messages for messages longer than 160 characters.

Double SMS example, part 1

ID	Description	Sample SMS ¹
%1;	SMS sequence number 1	%1;1=B450;2=secret123;15=3; 16=01020304050607080910111213141516;
1=B450;	Current password	
2=secret123;	New password (case sensitive)	
15=3;	Enable AES encryption	
16=01020304050607080910111213141516;	Sample AES key	
¹ As you enter in the various ID's into your cell phone, do not press the return key. Doing so will cause the module to ignore the programming request.		

Double SMS example, part 2

ID	Description	Sample SMS ²
%2;	SMS sequence number	%2;19=1;!
19=1;	Tamper enabled	
!	End of configuration	
² When you end the configuration programming with the exclamation mark, do not enter any values. Doing so may cause the module to ignore the programming request.		

5.4.2

Sending the inbound SMS

1. Make sure that the address switch on the module is set to 0.
2. Send the configuration SMS to the B44x module's phone number. The transmission might take several minutes.
3. Observe the LEDs on the module.

When the Transmit (TX) and Receive (RX) LEDs flash in unison at a 1-second interval, the module successfully received the SMS. If the module received an invalid SMS, the Transmit (TX) and Receive (RX) LEDs alternately flash at 1/2 second interval. Both flashing patterns continue until you move the bus address switch from position "0."

**Notice!**

If the LEDs indicate an invalid SMS, change the bus address switch from 0 and then back to 0 before you send a different SMS.

Refer to the tables in *Maintenance and troubleshooting, page 38* section for more information on LEDs. Make sure that the SMS contains the correct information, and that you entered the correct phone number for the module.

5.4.3**Exiting from CONFIG mode**

1. Change the bus address switch to the desired value, depending on the supported control panel.
2. Check the signal strength and Heartbeat LED for status.

6 Maintenance and troubleshooting

This section includes maintenance and troubleshooting information.

6.1 Firmware updates

You can send firmware updates through the USB interface. Use Tera Term. Update to the most recent version on the module web page.

Sending a firmware update

1. Make sure that the computer and the module are connected and can communicate. Follow the instructions in *USB configuration, page 22*.
2. From Windows, start Tera Term.
3. Log into the USB interface. The B450 USB login window appears, listing the current software version and build.
4. Select option 7 and press [Enter].



Notice!

Once you press [Enter], the module begins a 90-second timer as it waits for the firmware File>Transfer>XMODEM>Send process to begin. If the transfer process takes longer than 90 second to locate the file and begin the send process, the menu times out, and you must begin the update process again.

5. From the Tera Term main menu, select File>Transfer>XMODEM>Send.

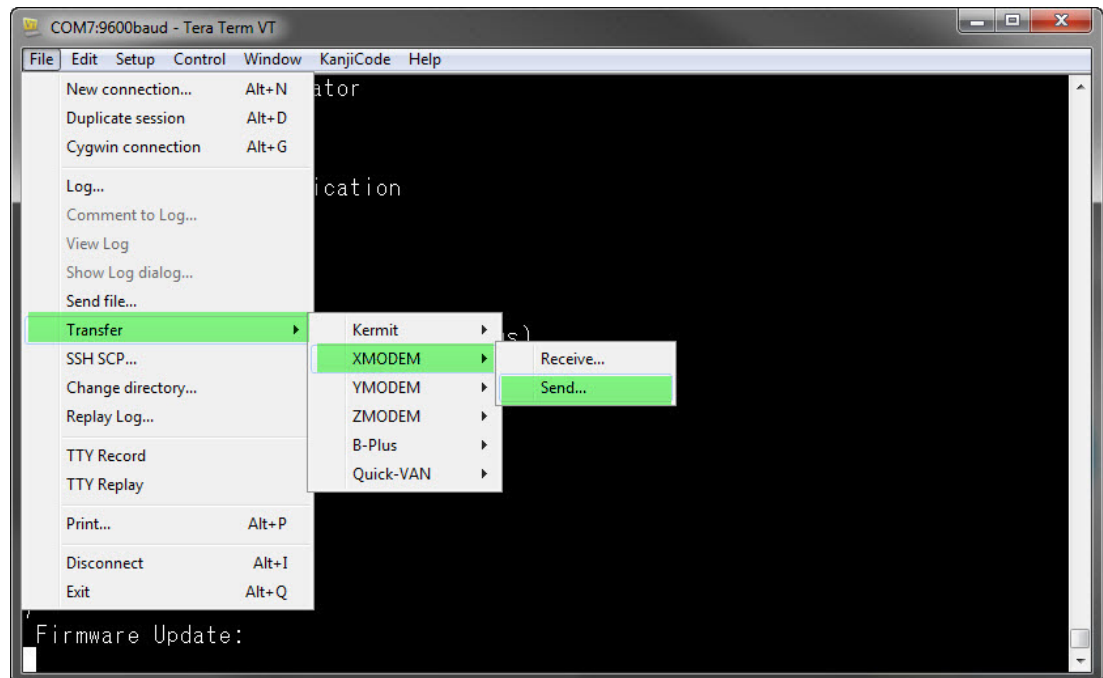

6. In the XMODEM Send window, navigate to the folder location and select the firmware update software you downloaded. The file ends in *.kfw extension.

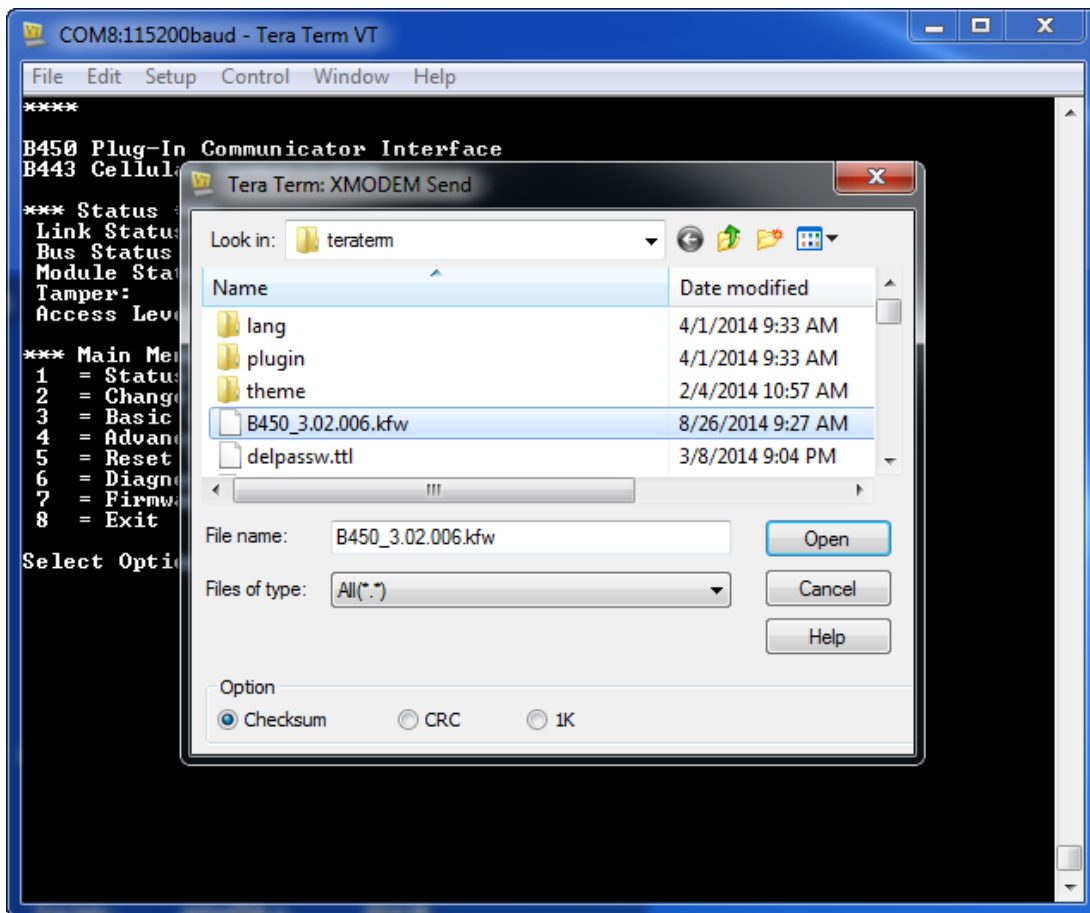

- 7. Click Open to start the firmware update. The Tera Term: XMODEM Send dialog box opens and indicates the update process.

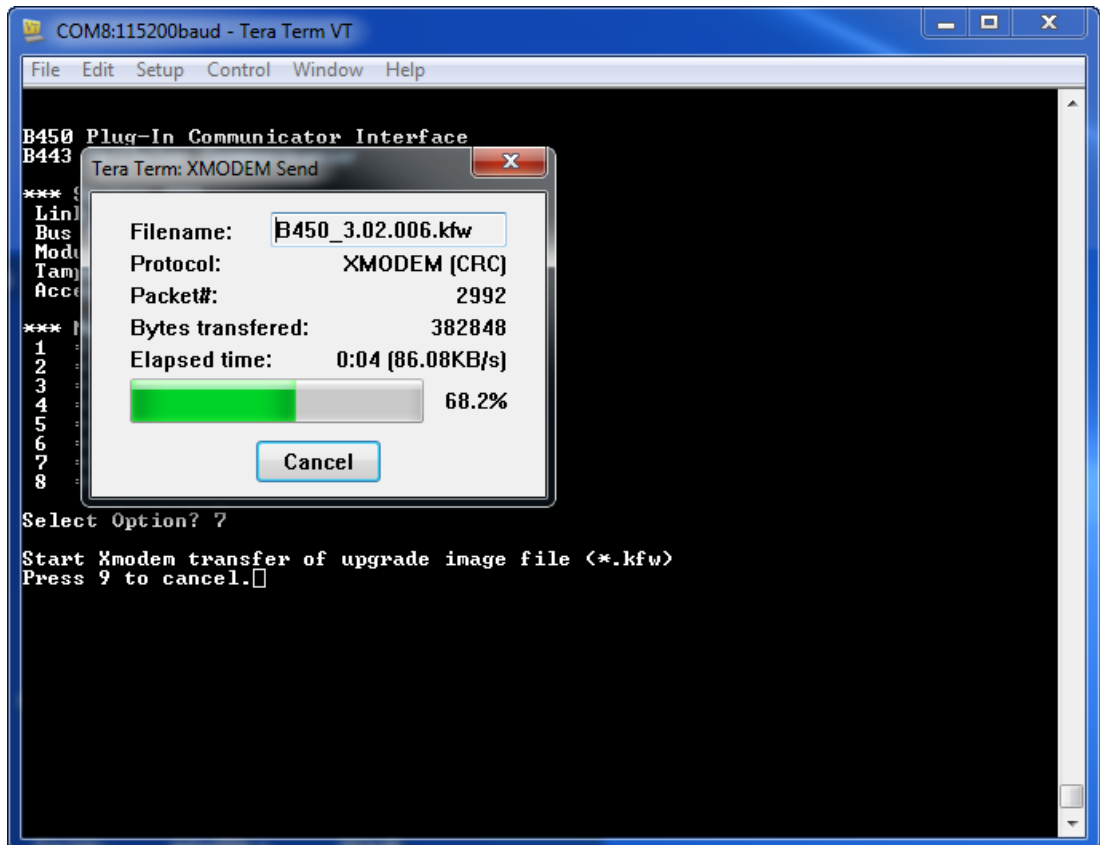

8. When the file transfer completes, the Tera Term: XMODEM Send dialog box closes. A Tera Term window show a message about updating to firmware version “x.xx.xxx”, and the module automatically reboots.
9. Close the Tera Term session, and relaunch Tera Term.
10. Log into Tera Term to reestablish the connection. Communication between the control panel and module restores.

6.2 USB menu access disabled

A *Menu access disabled* error message occurs when the Web/USB Access Enabled feature in RPS is set to No when connected to a GV4 Series v2.03+ or B Series v2.03+ control panel.

Enabling USB

1. Launch your session of RPS.
2. Log into RPS.
3. Select the correct control panel.
4. Select SDI2 MODULES > IP Communicator.
5. Double-click on Web/USB Access Enable, and select Yes. This allows you to view or change information from the module USB menu.

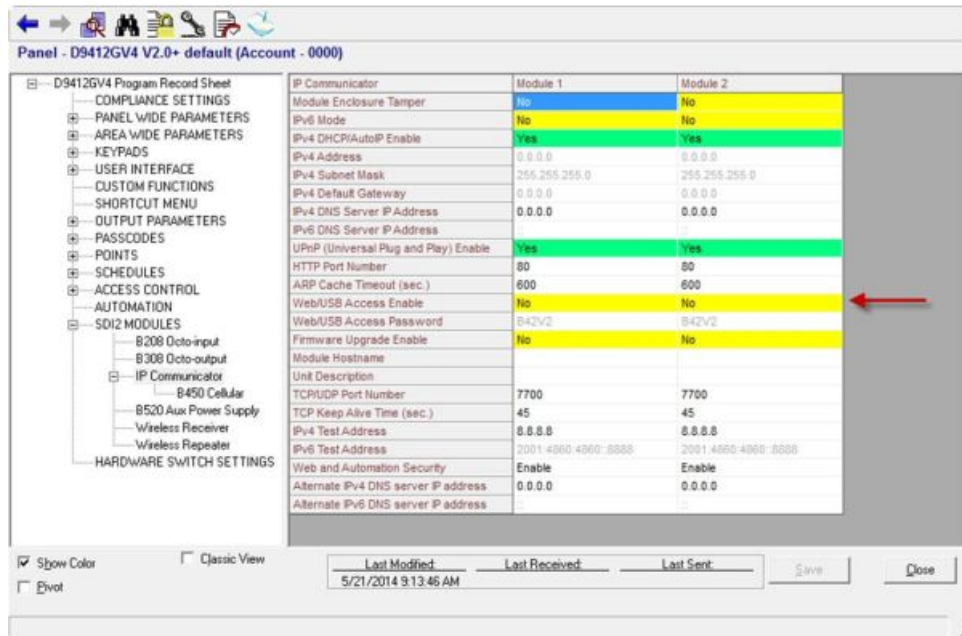



6. Send the configuration to the control panel.

6.3 LED status indicators

The module includes the following on-board LEDs to assist with troubleshooting:

- Heartbeat (system status)
- RX (receive)
- TX (transmit)

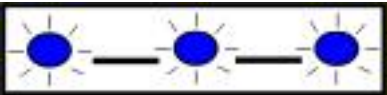
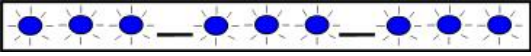
The plug-in module also includes LEDs for troubleshooting and status.

Flash pattern	Indication
 <p>Flashes once every 1 second</p>	Normal state.
 <p>3 quick flashes every 1 second</p>	Communication error state. Error on the bus between the module and the control panel.
 <p>On Steady</p>	Trouble state. Examine the other LEDs to determine the trouble condition.
 <p>Off</p>	LED trouble state. The module does not have power, or the module failed. Check for proper installation.

Tab. 6.1: Heartbeat LED descriptions

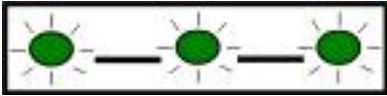
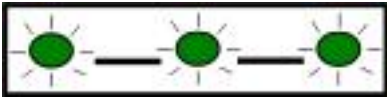

















Flash pattern	Function
RX (Receive) 	Occurs every time a packet is received on-air.
TX (Transmit) 	Occurs every time a packet is transmitted on-air.







Tab. 6.2: RX and TX LED descriptions

Plug-in communicator LEDs























For communicator LED information, refer to the compatible communicator documentation.

Module trouble condition LEDs

Condition	Module Heartbeat	Module Transmit (TX)	Module Receive (RX)	Plug-in module status
Module tamper	Not indicated			
Plug-in module missing	 On Steady	 Off	1 quick flash, repeating	N/A
SIM card missing	 On Steady	 Off	2 quick flashes, repeating	 Off
Plug-in module not recognized	 On Steady	 Off	3 quick flashes, repeating	 Off
Low bus voltage	 On Steady	 Off	4 quick flashes, repeating	 Off
Cellular modem failure	 On Steady	 Off	5 quick flashes, repeating	 Off
Switch position trouble	 On Steady	 Off	6 quick flashes, repeating	1 Hz Heartbeat
Configuration failure	 On Steady	 Off	7 quick flashes, repeating	

Condition	Module Heartbeat	Module Transmit (TX)	Module Receive (RX)	Plug-in module status
Invalid SIM PIN	 On Steady	 Off	8 quick flashes, repeating	 Off
SIM PUK required	 On Steady	 Off	9 quick flashes, repeating	 Off

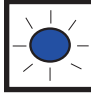
Plug-in module related trouble conditions

Condition	Module Heartbeat	Module Transmit (TX)	Module Receive (RX)	Plug-in module status
No IP address	 On Steady	 Off	 Off	2 quick flashes, repeating
Cellular number not activated	 On Steady	 Off	 Off	3 quick flashes, repeating
Not enough towers (single tower)	 On Steady	 Off	 Off	4 quick flashes, repeating
Invalid access point	 On Steady	 Off	 Off	5 quick flashes, repeating
Low signal strength	 On Steady	 Off	 Off	1 Hz Heartbeat
No towers	 On Steady	 Off	 Off	 On Steady
Detecting plug-in module type	 On Steady	 On Steady	 On Steady	 Off

SMS configuration LEDs

Condition	Module Heartbeat	Module Transmit (TX)	Module Receive (RX)	Plug-in module status
Invalid SMS message received	1 second flash	The Transmit (TX) and Receive (RX) LEDs will alternate flashing at 1/2 second interval		1 second flash
SMS configuration complete	1 second flash	The Transmit (TX) and Receive (RX) LEDs will flash in unison at a 1 second interval		1 second flash

6.4 Firmware version LEDs

The LEDs can flash in a pattern to show the module firmware version. The instructions are different for modules connected to a tamper switch and for modules not connected to a tamper switch.

Showing the module version with a LED flash pattern

- ▶ Do one of the following:
 - With a tamper switch connected, open the enclosure door. Activate the tamper switch.
 - Without a tamper switch connected, momentarily short the tamper pins.

The heartbeat LED stays Off for 3 seconds.

The LED pulses the major, minor, and micro digits of the firmware version, with a 1-second pause after each digit. For example, the version 1.4.3 shows as follows. [3 second pause] * _**** _*** [3 second pause, then normal operation].

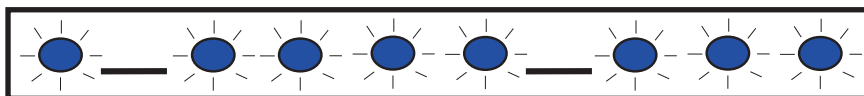

6.5 SIM card

For troubleshooting plug-in cellular modules that use SIM cards:

- Make sure that the SIM card is in the holder.
- Make sure that you install the SIM card before you apply power.
- Check for damage to the SIM card holder.
- Remove the SIM card from the holder. Make sure that the contacts are not worn. Insert the SIM card in the holder. Make sure that the holder holds the SIM card tight.
- Remove power from the system and then apply power to the system.
- If the problem persists after rebooting the system, replace the SIM card. You might need to reconfigure the module to match a new SIM card parameters.

6.6 Diagnostic log

You can use the Diagnostic Log option during an intermittent service outage, or communication error. Bosch Technical Support uses the generated diagnostic log file to determine how often a persistent problem occurs. The log includes detailed network configuration settings of the module during the time of the reported problem. Only use the Diagnostic Log option when directed by Bosch Technical Support.

Option	Description
--------	-------------

1. Modify Diagnostic Settings	Diagnostic logging is intended for use only under Bosch direction. Diagnostic settings determine which types of messages to show.
2. Re-print Saved Console Message	Prints any diagnostic messages that have already occurred and are stored in the module's buffer.
3. Enable Live Console Messages	Provides real time output of diagnostic messages. This allows the computer running TeraTerm to log module information for longer periods of time.

6.7 Network polling

Plan carefully when programming the control panel poll time, ACK wait times, retries, and D6x00 Receiver poll and supervision time. If you enter the incorrect control panel settings, trouble conditions can happen when the network carrier performs maintenance. Trouble conditions can increase data volumes that affect your monthly cost. Your settings for these parameters determine how the system works, but depend on the security level.

For more information regarding proper data plans and installation parameters related to network polling, refer to *Bosch Cellular Service User Guide* (P/N: F01U273558).

6.8 Control panel programming using cellular

For more information regarding proper planning and installation parameters related to VPN setup for control panel programming, refer to *Bosch Cellular Service User Guide* (P/N: F01U273558).

6.9 RPS Diagnostics

You can view B450 status information for SDI2 control panels in the Diagnostics window in RPS. The information shown and the path for the content depends on the control panel firmware version:

- Firmware v2.03+. Diagnostics > SDI2 > B450 Bus Device Cellular
- Firmware v2.00 - v2.02. Diagnostics > SDI2 > Ethernet Communicator
- Firmware v1.xx. Diagnostics > SDI2 > B420 Ethernet Communicator

7 Technical specification

Environmental

Relative humidity	Up to 93% at +32°C (+90°F) non-condensing
Operating temperature	0°C to +50°C (+32°F to +122°F)

Mechanical

Dimensions	79 mm x 128 mm x 38 mm (3.11 in x 5.03 in x 1.50 in)
------------	--

Electrical

Current (operating)	Standby: With cellular communicator = 60 mA Alarm: With cellular communicator = 180 mA
Voltage (operating)	(Bus operation): 12 VDC nominal

Wiring

Data bus wire gauge	12 AWG to 22 AWG (2.0 mm to .06 mm)
USB cable	USB cable (Type A to A male-to-male) – not supplied
Data bus wire length	Maximum Distance – wire size 22 AWG (0.6 mm) - 12 m (40 ft) 18 AWG (1.0 mm) - 30 m (100 ft) 16 AWG (1.3 mm) - 48 m (158 ft) 12 AWG (2.0 mm) - 122 m (400 ft) You can extend the wire distances 300 m (1000 ft). Use a separate power supply, such as the B520 Auxiliary Power Supply Module.

Compatibilities

Control panels - B450	B9512G/B8512G B6512/B5512/B4512/B3512 (B5512E/B4512E/B3512E with firmware v2.03 and higher) D9412GV4/D7412GV4/D7212GV4 (v1.00.0xx+) D9412GV3/D7412GV3/D7212GV3 D9412GV2/D7412GV2/D7212GV2 (v7.06+) FPD-7024 (v1.03+) CMS 6/8 CMS 40 Easy Series (v3+) AMAX 2100/3000/4000 Solution 2000/3000*
Control panels - B450-M	*AMAX 2000/2100/3000/4000/ *Solution 2000/3000
Cellular communicators	B442 (3G GPRS GSM) B443 (3G/4G HSPA+ GSM) B444 (4G VZW LTE)
Enclosures	B10 B11

	D8103 D203
Applications	Tera Term (for USB B450 configuration) Hyper Terminal (for USB B450 configuration) RPS version 5.16 or higher Remote Security Control (Supported on GV4, B9512G/ B8512G, B9512G-G/B8512G-E, B6512/B5512/B4512/B3512, B5512%/B4512E/B3512E, and Solution 2000/3000 Remote Security Control+ (Supported on AMAX and Solution Series control panel)
*The B450-M is compatible with AMAX and Solution control panels only.	



Notice!

The enclosure might cause temporary loss of communication due to static.



Bosch Security Systems, Inc.

130 Perinton Parkway

Fairport, NY 14450

USA

www.boschsecurity.com

© Bosch Security Systems, Inc., 2018

Bosch Sicherheitssysteme GmbH

Robert-Bosch-Ring 5

85630 Grasbrunn

Germany