

GE
Security

Vigilant VS1 and VS2 Technical Reference Manual



Copyright

© 2010 GE Security, Inc.

This document may not be copied in whole or in part or otherwise reproduced without prior written consent from GE Security, Inc., except where specifically permitted under US and international copyright law.

Disclaimer

The information in this document is subject to change without notice. GE Security, Inc. ("GE Security") assumes no responsibility for inaccuracies or omissions and specifically disclaims any liabilities, losses, or risks, personal or otherwise, incurred as a consequence, directly or indirectly, of the use or application of any of the contents of this document. For the latest documentation, contact your local supplier or visit us online at www.gesecurity.com.

This publication may contain examples of screen captures and reports used in daily operations. Examples may include fictitious names of individuals and companies. Any similarity to names and addresses of actual businesses or persons is entirely coincidental.

Trademarks and patents

GE and the GE monogram are trademarks of General Electric Company. The Vigilant VS1 and VS2 name and logo are trademarks of GE Security.

Other trade names used in this document may be trademarks or registered trademarks of the manufacturers or vendors of the respective products.

Intended use

Use this product only for the purpose it was designed for; refer to the data sheet and user documentation for details. For the latest product information, contact your local supplier or visit us online at www.gesecurity.com.

FCC compliance

This equipment has been tested and found to comply with the limits for a Class A digital device, pursuant to part 15 of the FCC Rules. These limits are designed to provide reasonable protection against harmful interference when the equipment is operated in a commercial environment. This equipment generates, uses, and can radiate radio frequency energy and, if not installed and used in accordance with the instruction manual, may cause harmful interference to radio communications.

You are cautioned that any changes or modifications not expressly approved by the party responsible for compliance could void the user's authority to operate the equipment.

Manufacturer

GE Security, Inc.

HQ and regulatory responsibility:
GE Security, Inc., 8985 Town Center Parkway, Bradenton, FL 34202, USA

EU authorized manufacturing representative:
GE Security B.V., Kelvinstraat 7, 6003 DH Weert, The Netherlands

Content

	Important information	v
	Minimum system requirements	viii
	To get started	ix
Chapter 1	Installation and wiring	1
	Cabinet box installation	2
	Panel electronics installation	3
	Cabinet wire routing	4
	AC power wiring	5
	Panel low voltage wiring	6
	Battery wiring (TB8)	7
	Notification appliance circuit wiring (TB2)	8
	Device loop wiring	11
	Alarm, trouble, and supervisory relay wiring (TB3)	13
	Remote annunciator wiring (TB4)	14
	Auxiliary/smoke power output wiring (TB3)	16
	SA-DACT wiring	18
	SA-232 wiring	20
	SA-CLA wiring	22
	SA-ETH wiring	24
	CTM module wiring	25
	RPM module wiring	26
Chapter 2	Front panel programming	29
	UL 864 programming requirements	31
	Getting started	32
	Device type descriptions	41
	Displaying the Program menu	45
	Setting the time and date	46
	Setting daylight saving time	47
	Changing the passwords	49
	Restoring the factory default settings	49
	Setting up the programmable keys	51
	Clearing the event history log	54
	Restarting the panel	55
	Enabling RS232 communication	55
	Auto programming the panel	56
	Performing incremental programming	64
	Adding and removing devices from programmed systems	67
	Advanced programming	76

Chapter 3	System operation 129
	Operation overview 131
	LCD display screen 132
	System LEDs 136
	LED display expander LEDs 137
	Control buttons 138
	Component descriptions 143
	Events with event messages 144
	Event ID numbers and descriptions 146
	Viewing event details 151
	Resetting the panel 151
	Silencing panel and annunciator buzzers 152
	Silencing notification appliances 152
	Conducting a lamp test 154
	Activating and restoring output devices 154
	Unlatching latched output devices 155
	Activating and restoring panel NACs 156
	Disabling and enabling devices 156
	Disabling and enabling zones 158
	Disabling and enabling panel events 159
	Disabling and enabling loop events 160
	Disabling and enabling panel NACs 162
	Disabling and enabling the dialer and network 163
	Initiating a fire drill 163
	Conducting a walk test 164
Chapter 4	Reports 167
	Basic steps for viewing and printing reports 168
	History report 168
	Walk Test report 170
	Device Maintenance report 170
	System Status report 171
	Correlation Groups report 172
	Correlation Group Configuration report 172
	Zone report 173
	System Configuration report 173
	Internal Status report 174
	Device Details report 175
	Diagnostics reports 176
	Internal Fault report 177
	Canceling a report 178

Chapter 5	Diagnostics, maintenance, and testing	179
	Preventive maintenance schedule	180
	Fast ground check	180
	Recalibrate device	181
	Loop comm check	181
	Control panel testing	183
	Testing a device (test fire)	184
	SA-DACT testing	184
	Conducting a lamp test	185
	Starting and stopping a walk test	186
	Using HyperTerminal	188
	Replacing a device in alarm	190
Appendix A	Panel specifications	191
	Control panel specifications	192
Appendix B	Worksheets	195
	Battery calculation worksheet	196
	Notification appliance circuit calculations worksheet	199
	Notification appliance voltage drop calculation worksheet	205
	Device loop maximum wire length worksheet	206
	Correlation groups worksheet	212
	Device settings worksheet	213
	Loop worksheet	215
	Panel configuration worksheet	216
	Panel operation worksheet	219
	Zone settings worksheet	220
Appendix C	Front panel menu flowcharts	223
	Main menu	224
	Reports menu (1 of 2)	225
	Reports menu (2 of 2)	226
	Test menu	227
	Control menu	228
	Program menu	229
	Program: Programmable Keys menu	230
	Advanced Program menu	231
	Advanced Program: Loop Configuration menu	232
	Advanced Program: Correlation Groups menu	233
	Advanced Program: Loop Configuration — Device menu	234
	Advanced Program: Panel Configuration menu	235
	Advanced Program: Panel Configuration — CMS Device menu	236
	Advanced Program: Panel Operation menu	237

Advanced Program: Panel Events menu 238
Advanced Program: Loop Events menu 239
Advanced Program: Unconfigured Alarm menu 240
Advanced Program: Common Trouble menu 240
Auto Program command menu flow 241
Incremental Program menu 242
Diagnostics menu 243

Appendix D Applications 245

Local alarm signaling applications 246
Correlated zone and system alarm signaling applications 247
In-suite signal silence applications 252

Appendix E Device types to personality codes correlation 257

Index 265

Important information

Limitation of liability

This product has been designed to meet the requirements of NFPA 72 *National Fire Alarm Code*, UL 864 *Standard for Control Units for Fire Protective Signaling Systems*, and ULC S527 *Standard for Control Units for Fire Alarm Systems*. Installation in accordance with this manual, applicable codes, and the instructions of the authority having jurisdiction is mandatory. GE Security shall not under any circumstances be liable for any incidental or consequential damages arising from loss of property or other damages or losses owing to the failure of GE Security products beyond the cost of repair or replacement of any defective products. GE Security reserves the right to make product improvements and change product specifications at any time.

While every precaution has been taken during the preparation of this manual to ensure the accuracy of its contents, GE Security assumes no responsibility for errors or omissions.

FCC compliance statement

This equipment can generate and radiate radio frequency energy. If the equipment is not installed in accordance with this manual, it may cause interference to radio communications. This equipment has been tested and found to comply with the limits for Class A computing devices pursuant to Subpart B of Part 15 of the FCC Rules. These rules are designed to provide reasonable protection against such interference when this equipment is operated in a commercial environment. Operation of this equipment is likely to cause interference, in which case the user, at his own expense, will be required to take whatever measures may be required to correct the interference.

SA-DACT FCC information

Cautions

- To ensure proper operation, this dialer must be installed according to the enclosed installation instructions. To verify that the dialer is operating properly and can successfully report an alarm, it must be tested immediately after installation, and periodically thereafter, according to the enclosed test instructions.
- In order for the dialer to be able to seize the phone line to report an alarm or other event when other customer equipment (telephone, answering system, computer modem, etc.) connected to the same line is in use, the dialer *must* be connected to

a properly installed RJ-31X jack. The RJ-31X jack must be connected in series with, and ahead of, all other equipment attached to the same phone line. Series installation of an RJ-31X jack is depicted in the wiring diagram. If you have any questions concerning these instructions, you should consult your telephone company or a qualified installer.

Testing

When programming emergency numbers or making test calls to emergency numbers, remain on the line and briefly explain to the dispatcher the reason for the call. Perform programming and testing activities in the off-peak hours, such as early morning or late evenings.

Compliance

- **For equipment approved before July 23, 2001:** This dialer complies with Part 68 of the FCC rules. A label attached to the dialer contains, among other information, the FCC registration number and ringer equivalence number (REN) for this equipment. If requested, this information must be provided to the telephone company.

For equipment approved after July 23, 2001: This dialer complies with Part 68 of the FCC rules and the requirements adopted by the Administrative Council for Terminal Attachments (ACTA). A label attached to the dialer contains, among other information, a product identifier in the format US:AAAEQ##TXXXX. If requested, this information must be provided to the telephone company.

- The plug and jack used to connect the dialer to the premises wiring and telephone network must comply with the applicable FCC Part 68 rules and requirements adopted by ACTA. The dialer must be connected to a compliant RJ-31X or RJ-38X jack using a compliant cord. If a modular telephone cord is supplied with the dialer, it is designed to meet these requirements. See installation instructions for details.
- A ringer equivalence number (REN) is used to determine how many devices you can connect to a telephone line. If the total REN value for all devices connected on a telephone line exceeds that allowed by the telephone company, the devices may not ring on an incoming call. In most (but not all) areas the total REN value should not exceed 5.0. To be certain of the total REN value allowed on a telephone line, contact the local telephone company.

For products approved after July 23, 2001, the REN is part of the product identifier in the format US:AAAEQ##TXXXX. The digits ## represent the REN without a decimal point. Example: 03 is an REN of 0.3. For earlier products the REN is listed separately.

- If the dialer is harming the telephone network, the telephone company will notify you in advance that temporary discontinuance of service may be required. If advance notice isn't practical, the telephone company will notify you as soon as possible. You will also be advised of your right to file a complaint with the FCC, if you believe it is necessary.
- The telephone company may make changes to its facilities, equipment, operations, or procedures that could affect the operation of the dialer. If this happens, the telephone company will provide advance notice in order for you to make necessary modifications to maintain uninterrupted service.
- If you are experiencing problems with the dialer, contact the manufacturer for repair or warranty information. If the dialer is harming the telephone network, the telephone company may request that you disconnect the dialer until the problem is resolved.
- The dialer contains no user serviceable parts. In case of defects, return the dialer for repair.
- You may *not* connect the dialer to a public coin phone or a party line service provided by the telephone company.

Industry Canada information

Note: The Industry Canada label identifies certified equipment. This certification means that the equipment meets certain telecommunications network protective, operational, and safety requirements. Industry Canada does not guarantee the equipment will operate to the user's satisfaction.

Before installing this equipment, users should ensure that it is permissible to be connected to the facilities of the local telecommunications company. The equipment must also be installed using an acceptable method of connection. The customer should be aware that compliance with the above conditions may not prevent degradation of service in some situations.

Repairs to certified equipment should be made by an authorized Canadian maintenance facility designated by the supplier. Any repairs or alterations made by the user to this equipment, or equipment malfunctions, may give the telecommunications company cause to request the user disconnect the equipment.

Caution: Users should not attempt to make connections themselves, but should contact the appropriate electrical inspection authority, or electrician, as appropriate.

Users should ensure for their own protection that the electrical ground connections of the power utility, telephone lines, and internal metallic water pipe system, if

present, are connected together. This precaution may be particularly important in rural areas.

Note: The Load Number (LN) assigned to each terminal device denotes the percentage of the total load to be connected to a telephone loop that is used by the device, to prevent overloading. The termination on a loop may consist of any combination of devices subject only to the requirements that the sum of the Load Numbers of all the devices does not exceed 100.

Minimum system requirements

The table below lists the minimum hardware requirements for each type of system for which the control panel is listed.

Table 1: Minimum hardware requirements for applications

System	Equipment needed
Protected Premises (Local) Fire Alarm System	Control panel Appropriately sized batteries
Auxiliary Fire Alarm System, Local Energy Type	Control panel Appropriately sized batteries CTM module
Remote Supervising Station Fire Alarm System	Control panel Appropriately sized batteries SA-DACT or RPM module
Central Station Fire Alarm System	Control panel Appropriately sized batteries SA-DACT or RPM module

To get started

If you are just starting out, follow the items in this checklist to prepare, install, wire, and program your fire alarm control panel.

1. Prepare the site. Make sure the installation location is free from construction dust and debris and extreme temperature ranges and humidity.
2. Unpack the equipment.
3. Install the cabinet box. See “Cabinet box installation” on page 2 for cabinet dimensions.
4. Install the panel electronics in the cabinet box. See “Panel electronics installation” on page 3.
5. Remove the clear protective plastic from the front panel display.
6. Install the optional panel accessories. Refer to each component’s installation sheet instructions.
7. Review Chapter 1 “Installation and wiring” starting on page 1.

WARNING: Make sure that the AC power circuit breaker is off before connecting wires to the terminal block.

8. Connect the field wiring. Meter for opens, grounds, and shorts before connecting.
9. Connect AC power and ground wiring. See “AC power wiring” on page 5. The panel cannot be started on batteries only.
10. Connect panel low voltage wiring. See “Panel low voltage wiring” on page 6.
11. Turn on AC power.
12. Connect the batteries. See “Battery wiring (TB8)” on page 7.
13. Program the panel. See Chapter 2 “Front panel programming” on page 29. If you are using the configuration utility, refer to the online help.
14. Test the system for proper operation.

Chapter 1

Installation and wiring

Summary

This chapter covers all control panel wiring, such as AC power, NACs, device loops, and battery wiring.

Content

Cabinet box installation	2
Panel electronics installation	3
Cabinet wire routing	4
AC power wiring	5
Panel low voltage wiring	6
Battery wiring (TB8)	7
Notification appliance circuit wiring (TB2)	8
Device loop wiring	11
Alarm, trouble, and supervisory relay wiring (TB3)	13
Remote annunciator wiring (TB4)	14
Auxiliary/smoke power output wiring (TB3)	16
SA-DACT wiring	18
SA-232 wiring	20
SA-CLA wiring	22
SA-ETH wiring	24
Circuit specifications	24
CTM module wiring	25
RPM module wiring	26

Cabinet box installation

The cabinet box can be surfaced mounted or semiflush mounted.

To surface mount the cabinet box:

1. Position the cabinet box on the finished wall surface.
2. Fasten the cabinet box to the wall surface where indicated.

To semiflush mount the cabinet box:

1. Frame the interior wall as required to support the full weight of the cabinet and standby batteries.
2. Install a semiflush trim ring (optional) to the cabinet.
3. Fasten the cabinet box to the framing studs where indicated.

Figure 1: Surface and semiflush mounting details

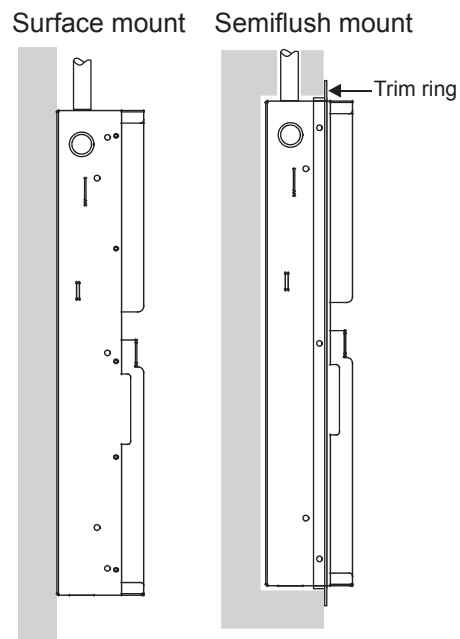

Figure 2: Cabinet backbox, backbox with door, and backbox with door and trim ring attached

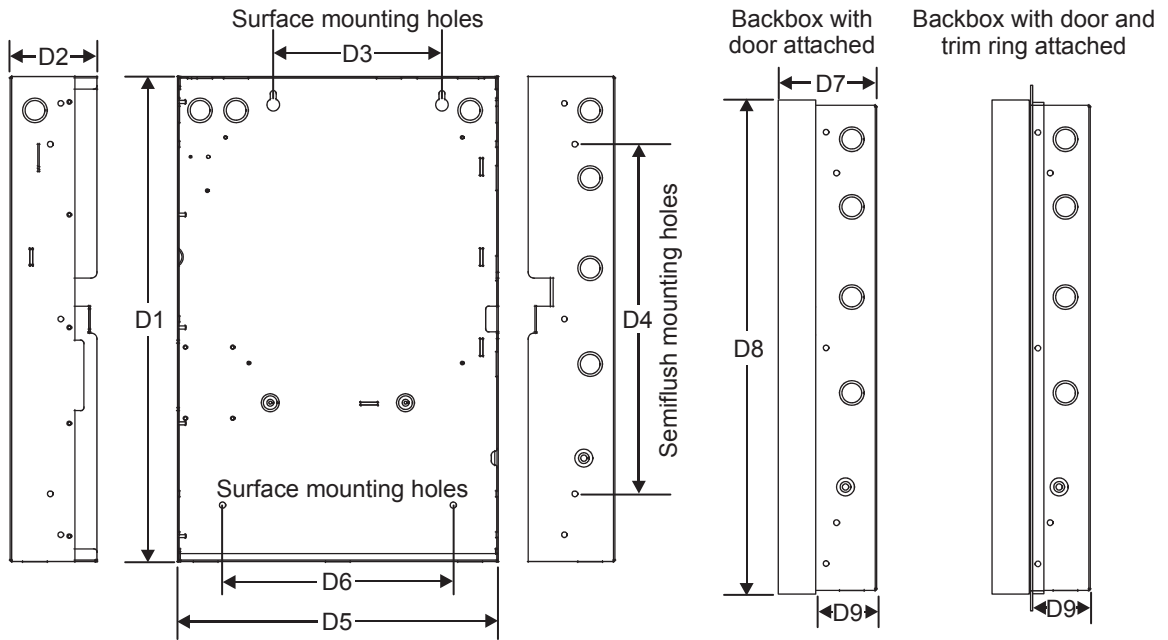

Table 2: Backbox and backbox with door dimensions (in. and cm)

Model	D1 [1]	D2	D3	D4	D5 [1]	D6	D7	D8	D9
VS1	21.50	3.85	7.5	15.50	14.25	10.25	4.9	23.6	2.7
	(54.6)	(9.8)	(19)	(39.4)	(36.2)	(26.0)	(12.4)	(59.9)	(6.8)
VS2	28.0	3.85	9.0	22.0	15.75	10.25	4.9	30.1	2.7
	(71.1)	(9.8)	(22.8)	(55.8)	(40.0)	(26.0)	(12.4)	(76.4)	(6.8)

[1] Add 1-1/2 in. (3.81 cm) to D1 and D5 dimensions for trim kit.

Panel electronics installation

The panel electronics must be installed in the cabinet box.

Note: Wait until the possibility of construction damage or vandalism has passed before installing the panel electronics.

Figure 4: Cabinet wire routing

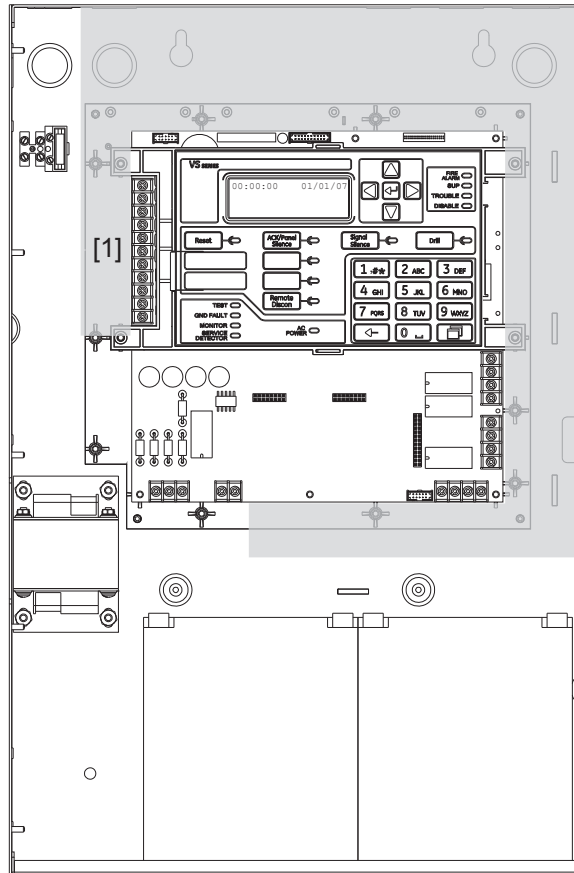

- [1] Power-limited only when connected to a power-limited source. If connected to a nonpower-limited source, all wiring on terminal block TB3 must be FPL, FPLP, FPLR rated wire or equivalent, in accordance with the NFPA 70 *National Electric Code* and routed separate from all power-limited wiring.

AC power wiring

Circuit specifications

- VS1 panel: 120 V, 60 Hz, 1.3 A or 230 V, 50/60 Hz, 0.6 A from dedicated branch supply
- VS2 panel: 120 V, 60 Hz, 1.8 A or 230 V, 50/60 Hz, 1.0 A from dedicated branch supply

WARNING: Never replace the fuse while the circuit is energized. The replacement fuse must be of equivalent size and type.

Caution: The middle connection (EARTH GND) on the terminal block makes a mechanical connection to the chassis even with the ground wire removed.

Figure 5: AC power wiring

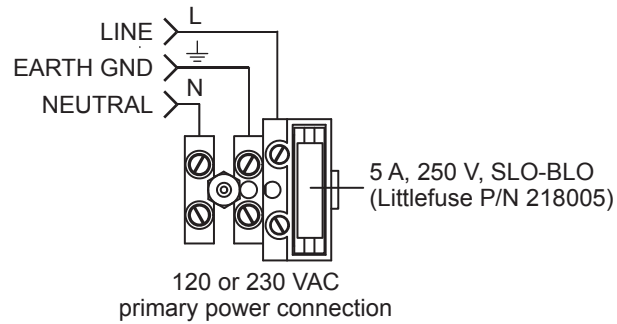

Note: See “Component descriptions” on page 143 for the location of the terminal block in the backbox.

Panel low voltage wiring

Circuit specifications

- Circuit voltage: 24 VAC
- All circuits are power-limited unless otherwise noted

Figure 6: Terminal wiring location

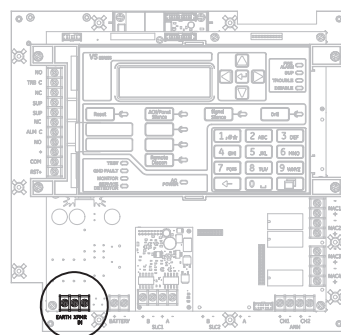
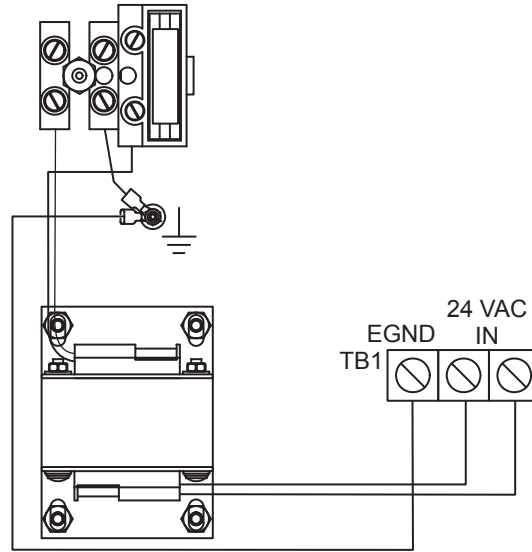

Figure 7: Panel low voltage wiring



Battery wiring (TB8)

Caution: Connect and disconnect standby batteries only with the AC power applied.

The control panel has a 24 VDC rechargeable battery circuit that is capable of charging up to two 26 Ah sealed lead acid batteries.

The table below lists the batteries that can be installed in the control panel cabinets. Up to two 10 Ah batteries will fit in the VS1 control panel cabinet and two 18 Ah batteries will fit in the VS2 point control panel cabinet. If larger batteries are required, you must use a GE Security battery cabinet. To determine which battery the system requires, use the "Battery calculation worksheet" on page 196.

Table 3: Batteries for EST iO64 and iO500 panels

Model	Manufacturer	Rating
12V4A	GS Battery, Inc.	12 volts, 4.5 Ah
12V6A5	GS Battery, Inc.	12 volts, 7.2 Ah
12V10A	GS Battery, Inc.	12 volts, 11 Ah
12V17A	GS Battery, Inc.	12 volts, 18 Ah
12V24A	GS Battery, Inc.	12 volts, 26 Ah

Figure 8: Terminal wiring location

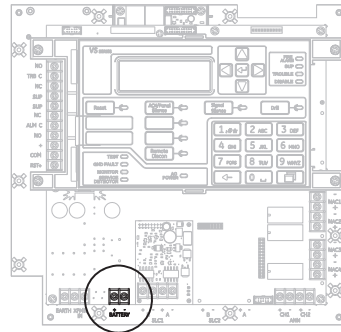
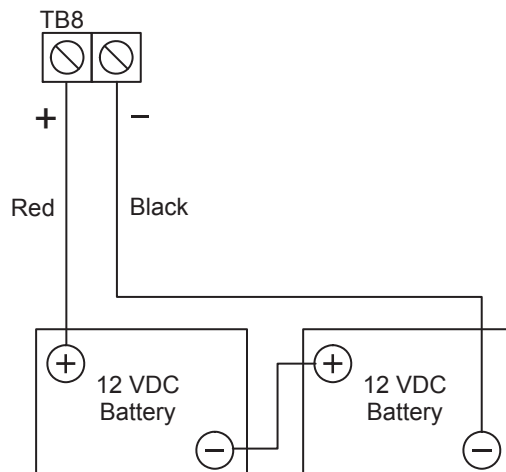

Figure 9: Battery wiring



Notification appliance circuit wiring (TB2)

The control panel provides either two or four notification appliance circuits depending on which model you have. Each circuit can be individually configured for continuous, temporal, synchronized, coded, or city tie output.

Circuit specifications

- Class B or Class A.
- Circuit voltage: 24 VFWR, regulated
- Circuit current

Vigilant VS1 panel:

3.75 A total, 2.5 A max. per circuit at 120/230 VAC 60 Hz

3.0 A total, 2.5 A max. per circuit at 230 VAC 50 Hz

Vigilant VS2 panel:

6.0 A total, 2.5 A max. per circuit at 120/230 VAC 60 Hz

5.0 A total, 2.5 A max. per circuit at 230 VAC 50 Hz

- Max. resistance: 26 Ω total
- Max. capacitance: 0.35 μ F
- EOLR: 15 k Ω , 1/2 W (P/N EOL-15)
- Synchronized or not synchronized. For NACs wired Class B, signal synchronization is supported system-wide (all NAC circuits).
- Ground fault impedance: 0 to 5 k Ω
- Power-limited and supervised

Notes

- On the Vigilant VS1 panel, Class A wiring is available only when the optional SA-CLA expansion card is installed. Refer to the “SA-CLA Class A Interface Card Installation Sheet” (P/N 3101094) and to the topic “SA-CLA wiring” on page 22.
- Listed EOLRs must be installed as shown for proper supervision.
- Marking indicates output signal polarity when the circuit is active. Polarity reverses when the circuit is not active. Wire notification appliances accordingly. Notification appliance polarity shown in active state.
- Installation limits are subject to acceptance by the Authority Having Jurisdiction (AHJ).

Figure 10: Terminal wiring location

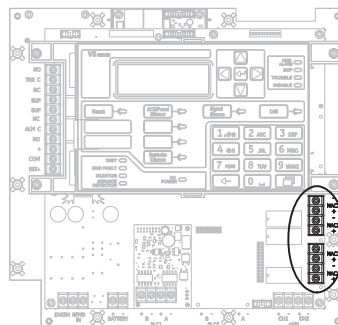

Figure 11: VS1 panel Class B wiring

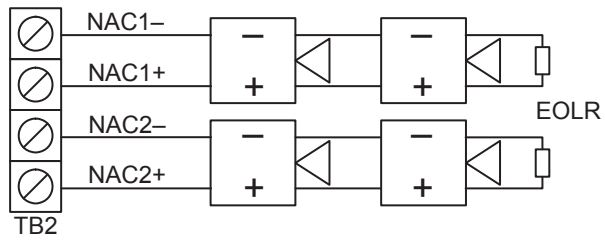

Figure 12: VS2 panel Class B wiring

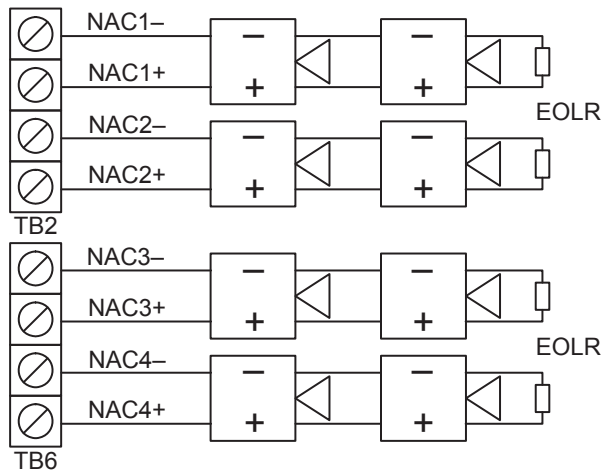
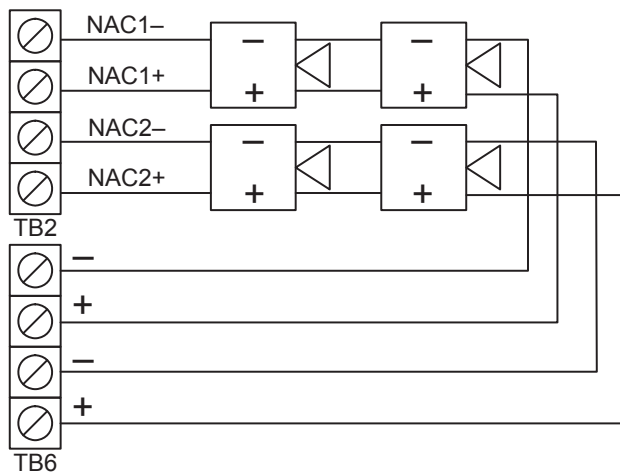

Figure 13: VS2 panel Class A wiring



Device loop wiring

The control panel provides one device loop circuit that can be used with detectors and modules. See “Setting up a HyperTerminal connection” on page 188 for the number of devices (device addresses) that can be wired on a loop. The loop circuit is supervised for opens, shorts, and grounds.

Note: For a complete list of devices that can be connected to this circuit, refer to the *VS1 and VS2 Series Compatibility List* (P/N 3101065).

Circuit specifications

- Class B or Class A
- Communication line voltage: Maximum 20.6 V peak-to-peak
- Circuit current: 0.5 A max.
- Max. total resistance: 66 Ω
- Max. total capacitance: 0.7 μF
- Max. resistance between isolators: Limited only by overall wire run lengths
- 64 isolators maximum (total both isolator bases and modules)
- Ground fault impedance: 0 to 5 k Ω
- Power-limited and supervised
- Signal synchronization is supported on a system-wide basis (all device loops) when using GSA-CC1S or GSA-MCC1S addressable NAC modules and Genesis or Enhanced Integrity notification appliances.

Installation limits are subject to acceptance by the Authority Having Jurisdiction (AHJ).

Figure 14: Terminal wiring location

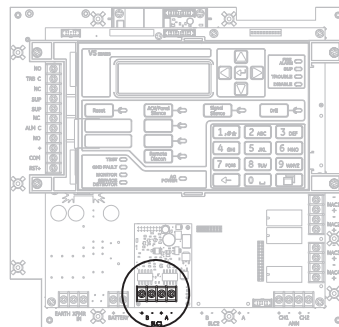

Figure 15: Class B wiring (Style 4)

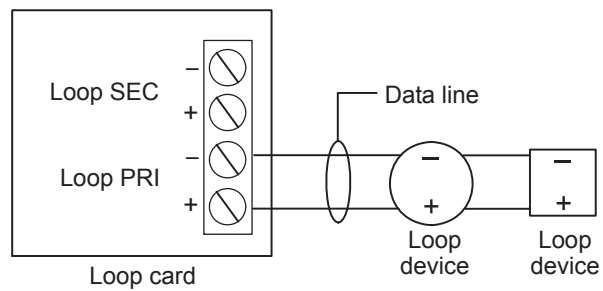

Figure 16: Class A wiring (Style 6)

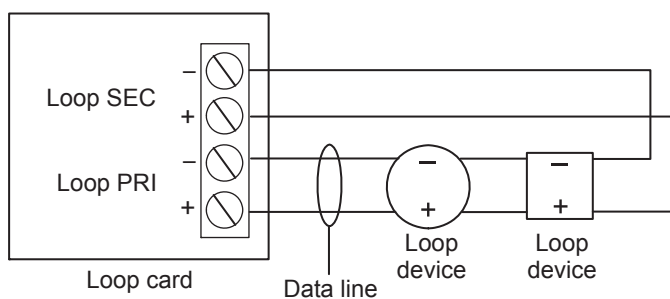
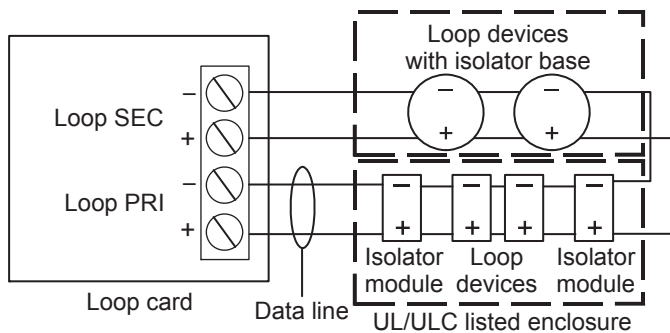

Figure 17: Class A wiring (Style 7)



Loop card LEDs

There are three LEDs on the card that indicate loop communication status. Primary is the primary communication circuit. Secondary is the Class A return communication when wiring is Class A.

Figure 18: Loop card LEDs

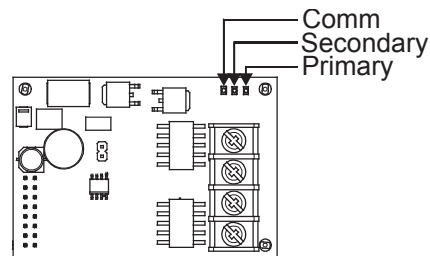

"Comm" refers to overall communication

Alarm, trouble, and supervisory relay wiring (TB3)

The control panel provides alarm, trouble, and supervisory relays.

- The trouble relay changes over on any trouble event (common trouble)
- The supervisory relay changes over on any supervisory event (common supervisory)
- The alarm relay changes over on any alarm event (common alarm)

Note: Relay circuits can only be connected to power-limited sources. Relays are not supervised.

Relay specifications

- Alarm and trouble: Form C, 24 VDC at 1 A resistive
- Supervisory: Form A, 24 VDC at 1 A resistive

Figure 19: Terminal wiring location

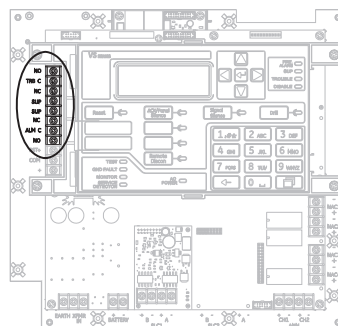
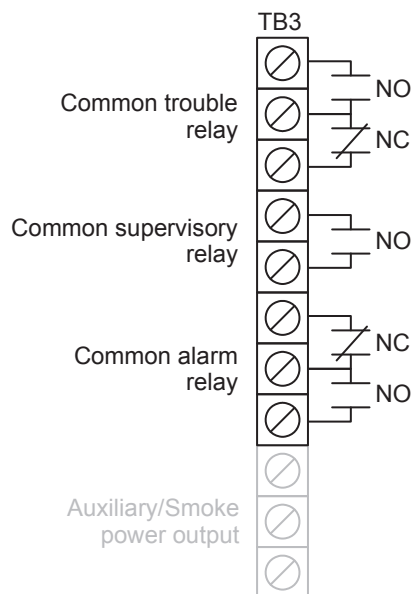

Figure 20: Relay wiring terminals



- All relays circuits are unsupervised. Must be connected only to a power-limited source.
- Alarm and trouble: Form C, 24 VDC at 1 A resistive
- Supervisory: Form A, 24 VDC at 1 A resistive
- Diagram is shown with the panel in a normal state.

Remote annunciator wiring (TB4)

The control panel provides a connection for up to eight remote annunciators.

Circuit specifications

- Class B or Class A

Note: The Vigilant VS1 panel requires the SA-CLA card to support Class A and redundant Class B circuits. Refer to installation sheet P/N 3101094.

- Circuit voltage: 2.55 V peak-to-peak average
- Circuit current: 30 mA max.
- Circuit impedance: Up to 8 annunciators or 4,000 feet (1,219 m) of 18 AWG wire
- Circuit resistance: 90 Ω
- Circuit capacitance: 0.3 μF
- Ground fault impedance: 0 to 5 k Ω

- RS-485 communications speed: 9600 baud
- Wiring: 18 to 14 AWG (1.0 to 2.5 sq. mm) twisted pair
- Max. wire run: 4,000 feet (1,219 m)
- Power-limited and supervised

Notes

- Refer to the *R-Series Remote Annunciators and Expander Installation and Operation Guide* (P/N 3100969) or the R-Series annunciator installation sheets for detailed wiring information
- Installation limits under jurisdiction of local authority

Figure 21: Terminal wiring location

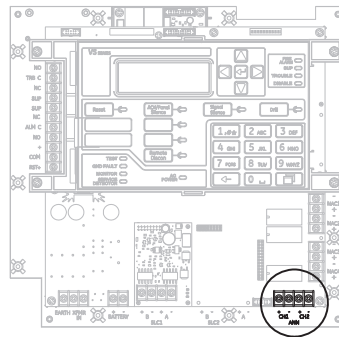

Figure 22: Annunciator channel wiring (Class A)

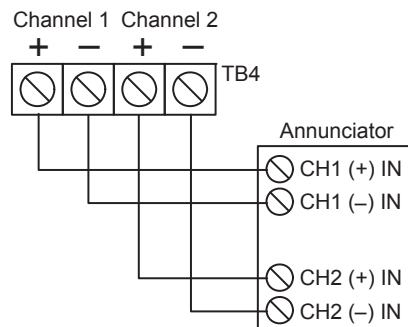
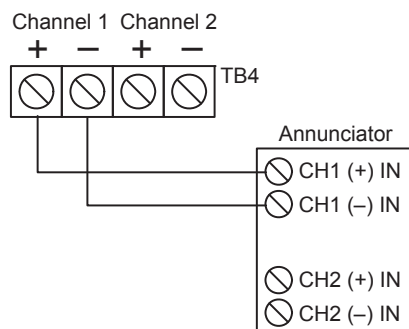

Figure 23: Annunciator channel wiring (Class B)



Auxiliary/smoke power output wiring (TB3)

The control panel provides resettable and continuous AUX power output circuits. Use the resettable AUX power output for devices such as four wire detectors or beam detectors. Use the continuous AUX power output for devices such as remote annunciators or door holders.

Note: If you do not need resettable AUX power, you can configure the resettable AUX power output to supply continuous power.

Note: For a complete list of devices that can be connected to this circuit, refer to the *VS1 and VS2 Series Compatibility List* (P/N 3101065).

Circuit specifications

- Circuit voltage range: 21.9 to 28.3 V
- AUX 1 + AUX 2 can supply 1.5 A total. If more than 1.5 A is required, you must use a power-limited and regulated 24 VDC auxiliary/booster power supply that is UL/ULC listed for fire protective signaling systems.
- Continuous circuit (AUX power 1): 24 VDC nominal at 500 mA. Use this circuit to supply 24 VDC continuous power. A SMK module is required when using the GSA-UM module to support two-wire smoke detectors.
- Resettable circuit (AUX power 2): 24 VDC nominal at 500 mA (1 A possible if you reduce total available NAC power by 500 mA). Use this circuit provide 24 VDC resettable power.
- Special application circuits
- Ground fault impedance: 0 to 5 k Ω
- Supervised and power-limited

Figure 24: Terminal wiring location

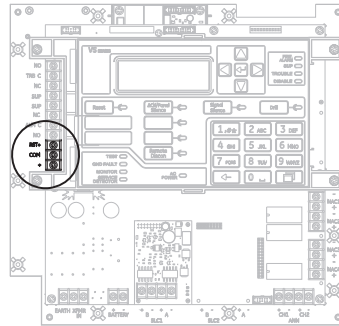
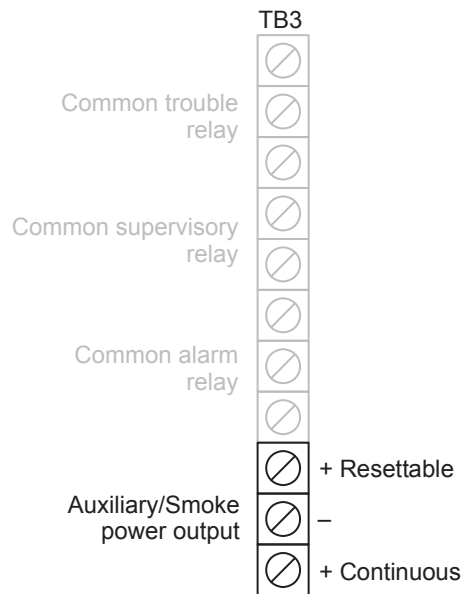

Figure 25: Auxiliary/smoke power output terminals



SA-DACT wiring

The optional SA-DACT provides communications between the control panel and the central station over a telephone line system. The SA-DACT is listed for use with the following DACRs.

Table 4: DACRs listed for use with SA-DACT

Receiver	Models	Formats
Ademco	685	Contact ID
FBII	CP220	Contact ID
Osborne-Hoffman	OH2000 and OH2000E with an OH2000E-LC line card installed (see note below)	Contact ID
Radionics	D6600	Contact ID
Silent Knight	9500, 9800	Contact ID
Sur-Gard	MLR1, MLR2, MCDI TLR, TLR+, SG-SLR, MLR2000	Contact ID

Note: If the line card firmware is V2.2 or later, use the default CMS network settings. If the line card firmware is V2.2 or earlier, the Timeout Seconds must be set to 60, the Hello Timer set to 75, and the Line Cut timer in the line card itself set to 175 seconds. If you are unsure of the firmware version in the receiver or there are communication faults between the panel and the receiver, then these settings are recommended.

Phone lines connect to the dialer using connectors on the dialer's main circuit board. Phone line 1 connects to connector J1 and phone line 2 connects to connector J4.

The card typically connects to an RJ-31X block using an eight-position, four-conductor modular cord. Wire the RJ-31X block as shown below.

Note: Install a listed secondary telephone protector between the telco network and the SA-DACT card. The SA-DACT card must be the next piece of equipment that connects to the telephone company (TELCO) telephone lines.

Circuit specifications

- Operating current
Standby/Alarm: 41 mA
Max.: 100 mA
- Phone line type: One or two loop-start lines on a public, switched network
- Phone line connector: RJ-31/38X (C31/38X)

Figure 26: Terminal wiring location

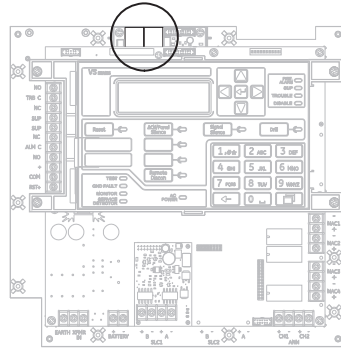
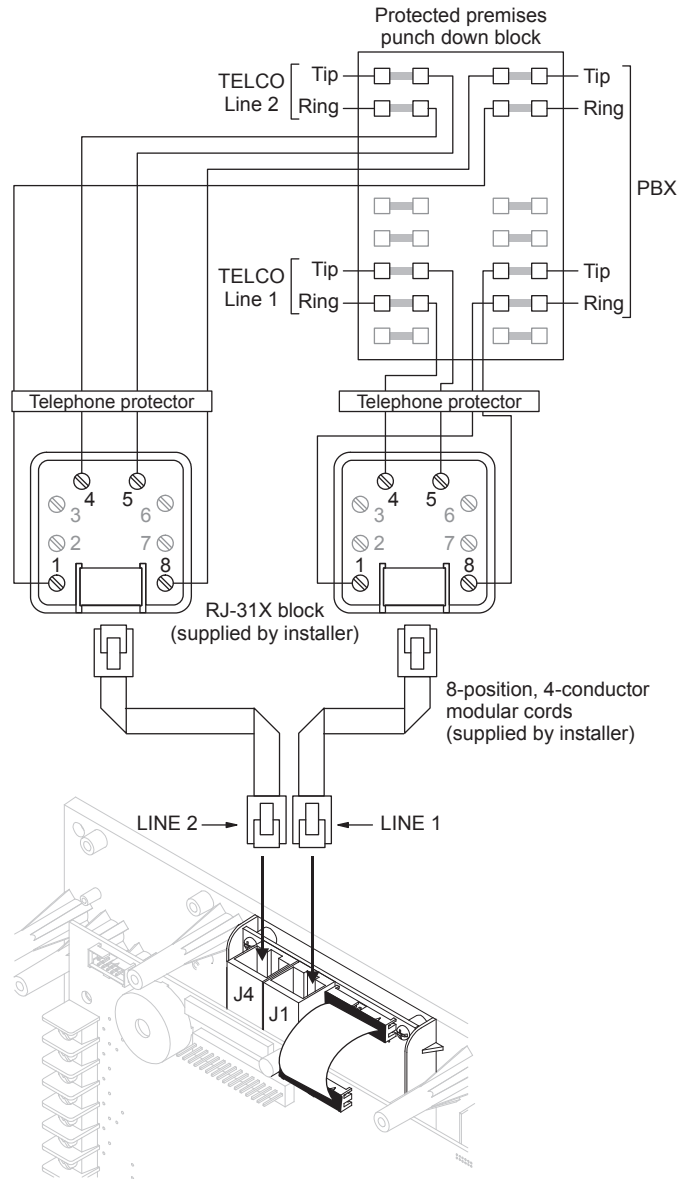

Figure 27: SA-DACT wiring



SA-232 wiring

The optional RS-232 card can be wired to a printer to print system events or wired to a computer to download to the panel.

Circuit specifications

- Serial communications
Asynchronous communications maximum resistance: 13 Ω
Maximum capacitance: 0.7 μF
- Wire length: 50 feet max.
- Signal voltage: +/- 10 V
- Operating current
Standby/Alarm: 13 mA
Max.: 20 mA
- Printer communication speed: 9600 baud
- Power-limited and unsupervised. Supervised when the Supervised Printer panel programming option is enabled.

Figure 28: SA-232 wiring terminals

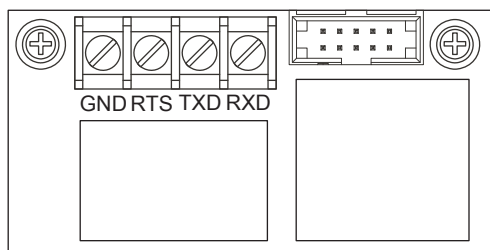

Printer wiring

Note: The printer must be configured through programming for proper operation.

To install wiring to a printer:

1. Locate the serial port on the back of the printer.
2. Connect the DB-25 end of the RS-232 cable to the serial port on the back of the printer.
3. Connect the other end of the RS-232 cable to the RS-232 card.

Figure 29: Printer wiring

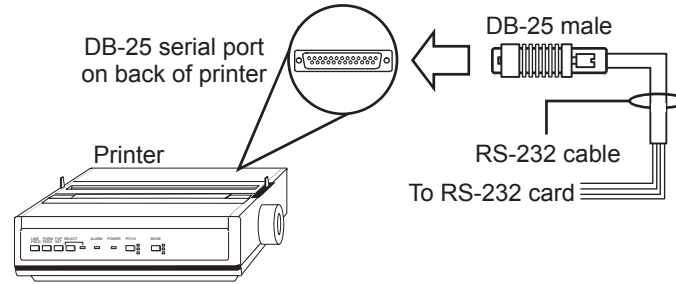

Figure 30: DB-25 pin connections

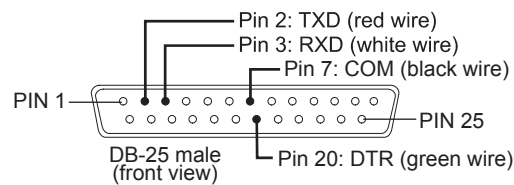

Table 5: SA-232 card to printer DB-25 connections

SA-232 card	DB-25	Description
GND	COM (pin 7)	Black wire (ground connection)
RTS	DTR (pin 20)	Green wire (printer supervision)
TXD	RXD (pin 3)	White wire (communication)
RXD	TXD (pin 2)	Red wire (communication)

Computer download wiring

To install wiring to a computer:

1. If you have a connected printer, disconnect it.
2. Locate a serial port (COM port) on the back of the computer.
3. Connect the DB-9 end of the RS-232 cable to the COM port on the back of the computer.
4. Connect the other end of the RS-232 cable to the RS-232 card.

Figure 31: Computer download wiring

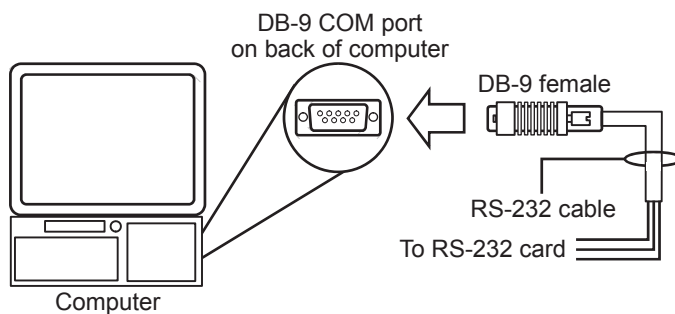

Figure 32: Pin designations on female DB-9 plug (back view)

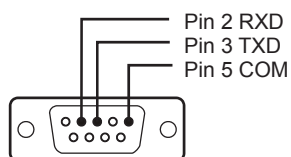

Table 6: SA-232 card to computer DB-9 connections

SA-232 card	DB-9	Description [1]
GND	COM (pin 5)	Black wire (ground connection)
RTS	-	Not used
TXD	RXD (pin 2)	White wire (communication)
RXD	TXD (pin 3)	Red wire (communication)

[1] Wire colors refer to GES Model 260097 RS-232 Cable

SA-CLA wiring

The SA-CLA card is used to supply wiring for Class A NACs and redundant Class B remote annunciator circuits on VS1 control panels.

Circuit specifications

- Operating current
Standby: 3 mA
Alarm: 60 mA max.
- Max. resistance: 26 Ω
- Max. capacitance: 0.35 μF
- Max. current: 2.5 A per circuit

- Ground fault impedance: 0 to 5 kΩ
- Power-limited and supervised

Figure 33: SA-CLA Class A NAC wiring

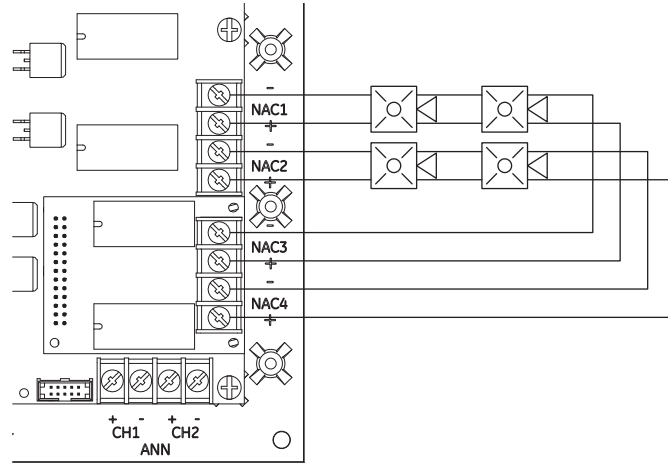
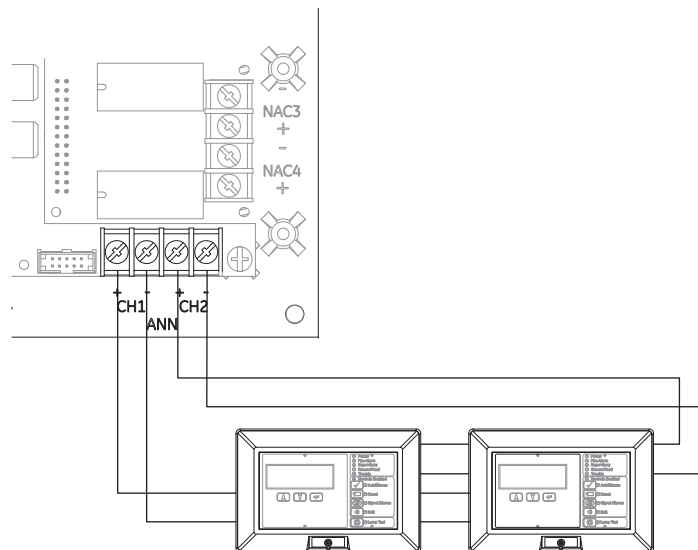

Figure 34: SA-CLA Redundant Class B remote annunciator circuit



SA-ETH wiring

The optional SA-ETH card provides a standard Ethernet network connection for connecting to a local network.

Circuit specifications

- Ethernet: 10/100 Base-T
- Network cable: Crossover cable or straight through cable
- Operating current
Standby/Alarm: 34 mA
Max.: 41 mA
- Max. wire runs: 200 feet (60 m), Cat 5 cable (panel to communication equipment)

Figure 35: SA-ETH wiring

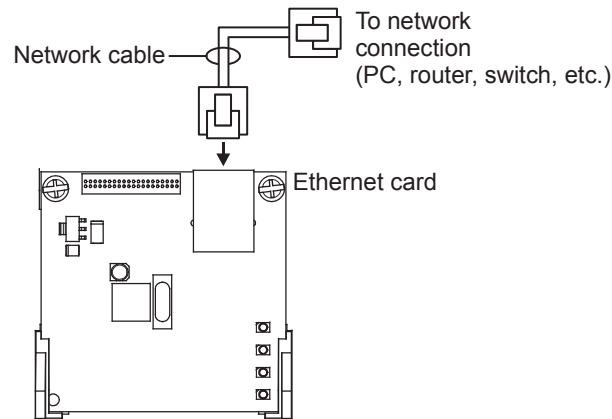
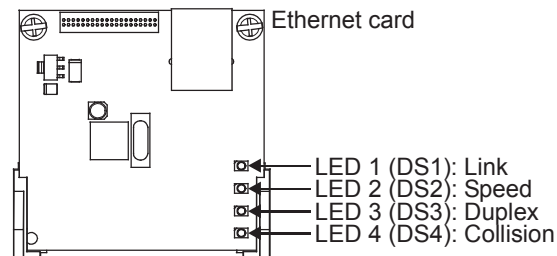

Figure 36: SA-ETH LEDs



CTM module wiring

The CTM City Tie Module is an interface between the control panel notification appliance circuit and a master box. It provides off-premises signal transmission for systems that must comply with NFPA requirements for Auxiliary Protective Systems. The CTM activates a local energy fire alarm box. For detailed information and wiring, refer to the *CTM Installation Sheet* (P/N 3101025).

Requirements

When connecting a CTM to the panel, the following hardware and programming requirements must be met:

- The NAC used must be dedicated to CTM use only
- All alarm zones must be programmed to activate the dedicated NAC
- The NAC used must not be programmed for signal silence

Wiring

The following wiring diagrams show how the polarity switches during an alarm condition.

Figure 37: CTM module wiring (panel in normal condition)

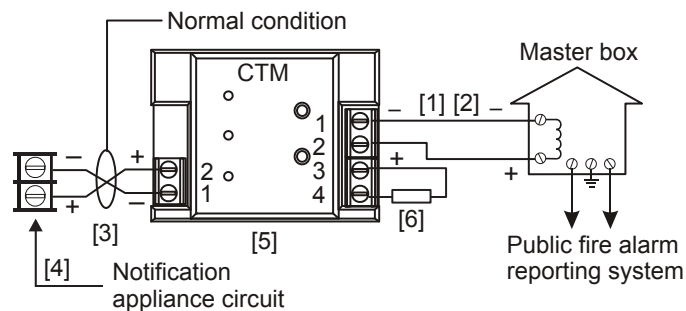
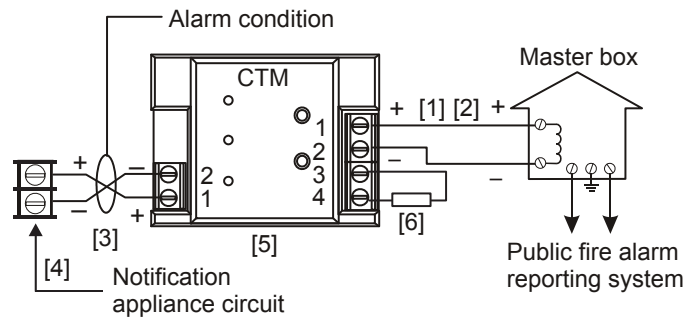

Figure 38: CTM module wiring (panel in alarm condition)



- | | |
|--|---|
| [1] 200 mA into a 14.5 Ω trip coil max. loop resistance = 25 Ω | [4] NAC must be programmed for city tie |
| [2] This circuit is nonpower-limited and is supervised for grounds and opens, but not shorts | [5] CTM must be mounted in the same room as the panel |
| [3] Supervised and power-limited | [6] 15 kΩ end-of-line resistor |

RPM module wiring

The Reverse Polarity Module (RPM) is an interface between the control panel and a reverse polarity receiver. It provides off-premise signal transmission for systems that must comply with NFPA requirements. When used as a reverse polarity remote station transmitter, it can be connected to either a single circuit (alarm or alarm and trouble) or up to three circuits (alarm, supervisory, and trouble). Below are application diagrams for using the RPM module. For detailed information and wiring, refer to the *RPM Installation Sheet* (P/N 3100430).

Notes

- The RPM must be mounted in conduit, in an MFC-A enclosure, immediately adjacent to the panel.
- All relays are unsupervised and must be connected to a power-limited source.

Figure 39: Terminal wiring location

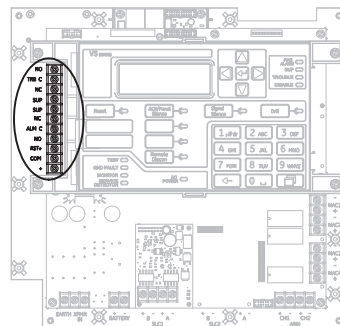

Figure 40: Alarm transmitted only

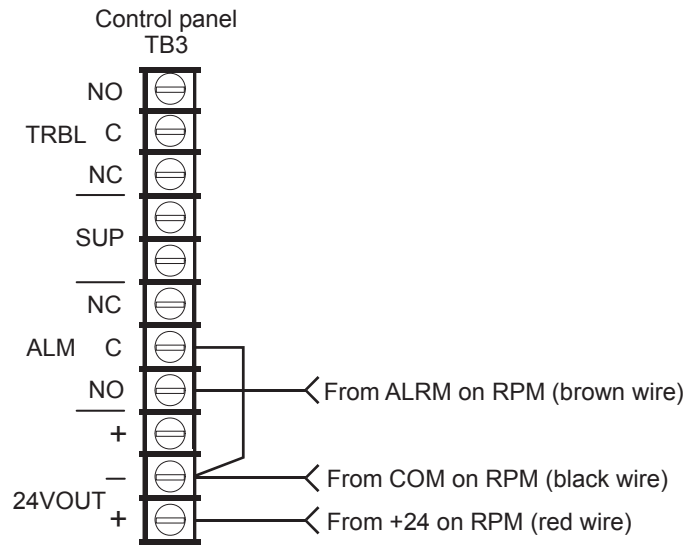
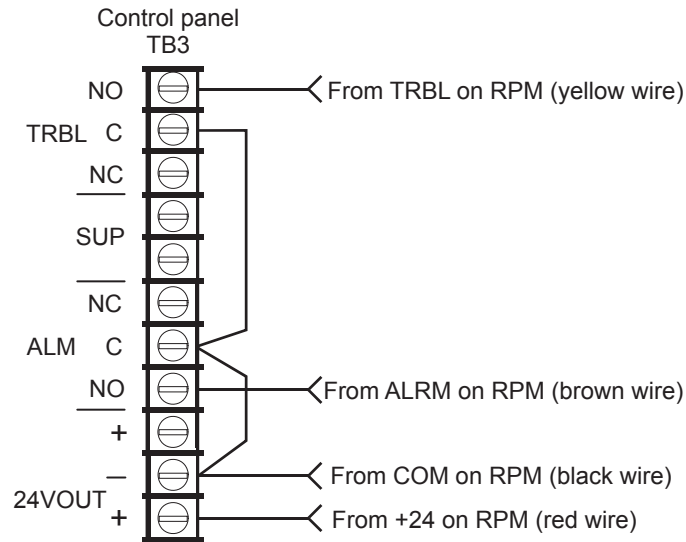
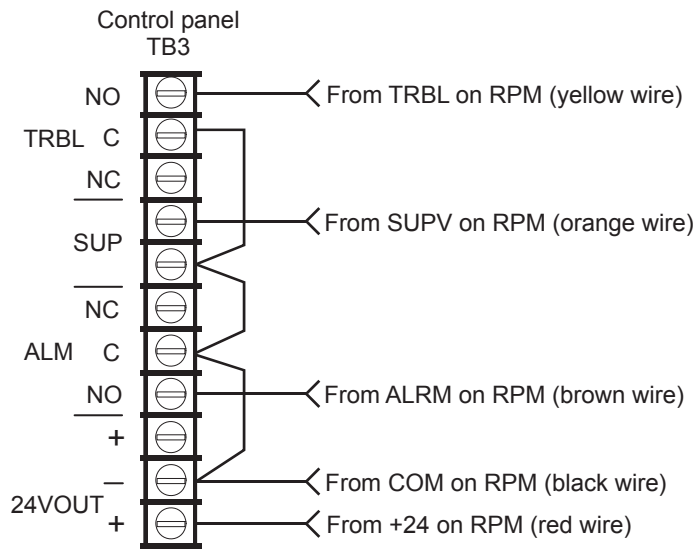

Figure 41: Alarm and trouble transmitted on a single circuit



Note: JP1 on the RPM must be OUT.

Figure 42: Alarm, supervisory, and trouble transmitted on separate circuits



Note: JP1 on the RPM must be IN.

Chapter 2

Front panel programming

Summary

This chapter shows how to configure the system using the control buttons on the front panel. For information on programming the system using the optional Configuration Utility (CU), refer to the online help available in the CU.

Content

UL 864 programming requirements	31
Getting started	32
What is a zone?	32
What is a correlation group?	32
What is in-suite signal silence?	33
Programming modes	34
Using the programming control buttons	35
Factory default settings	35
Device type descriptions	41
Displaying the Program menu	45
Setting the time and date	46
Setting daylight saving time	47
Sample values for daylight saving time	48
Changing the passwords	49
Restoring the factory default settings	49
Setting up the programmable keys	51
Clearing the event history log	54
Restarting the panel	55
Enabling RS232 communication	55
Auto programming the panel	56
Auto programming options	57
Dialer options	59
NET options	61

- Auto programming procedure 62
- Labeling devices 63
- Labeling zones 63
- Performing incremental programming 64
 - Incremental programming options 64
 - Incremental programming procedure 65
 - Labeling devices 66
 - Labeling zones 67
- Adding and removing devices from programmed systems 67
 - Device programming options 68
 - Adding devices 75
 - Removing devices 76
- Advanced programming 76
 - Overview 76
 - Changing loop configuration options 78
 - Correlation group programming 79
 - Programming in-suite signal silence 83
 - Programming fast groups for sounder bases 85
 - Device programming 87
 - Programming relay and sounder detector bases 95
 - Programming relay modules and bases as latched output devices 96
 - Loop 2 enable 98
 - Mapping loop device circuits 99
 - Zone programming 101
 - Panel programming 103
 - Central monitoring station device programming 108
 - Panel operation programming 117
 - Event programming 120

UL 864 programming requirements

NOTICE TO USERS, INSTALLERS, AUTHORITIES HAVING JURISDICTION, AND OTHER INVOLVED PARTIES				
This product incorporates field-programmable software. In order for the product to comply with the requirements in the Standard for Control Units and Accessories for Fire Alarm Systems, UL 864, certain programming features or options must be limited to specific values or not used at all as indicated below.				
Programmable feature or option	Permitted in UL 864? (Y/N)	Possible settings	Settings permitted in UL 864	Panel default
AC fail delay	Y	0 to 15 hours	1 to 3 hours	3 hours
Telephone line cut supervision duration	Y	1 to 120 seconds	10 to 120 seconds	120 seconds
Test signal frequency	Y	0 to 45 days	1 (daily)	1 (daily)
Dialer mode	Y	Dual line Single line Modem only None	Dual line Single line [1] Modem only [2] None [2]	Dual line
Send event restore codes	Y	No Yes	Yes	Yes
Swinger shutdown	N	Off 1 to 255	Off	Off
Zone resound	Y	On Off	On	On
<p>[1] Allowed only when the supervising station supervises the telephone line and annunciates fault conditions within 200 seconds</p> <p>[2] Prohibited when the control panel is connected to a supervising station</p>				

Getting started

You can program the system using the command buttons on the front panel or a PC with the optional configuration utility (CU). If you plan to use the configuration utility, refer to the online help system for complete programming instructions.

What is a zone?

A zone is a collection of points that are grouped together in the project database in the same manner that the system designer divided the protected premises. Zones provide a single zonal response and are used to limit the number of event messages processed by the system. Firewall designations, planned evacuation criteria, architectural design, and other factors determine how points are grouped into zones.

What is a correlation group?

A correlation group is a collection of inputs that activate a collection of outputs. During loop configuration, input devices, zones, and events are correlated with NACs, zones, and output devices.

Output activations depend on an option called the activation count. This controls the number of input activations required to activate the group's outputs. For example:

- If the correlation group's activation count is 1, the activation of any input device in the group turns on every output device in the group.
- If the activation count is 3, every output device in the group is activated when 3 input devices activate.

Figure 43: Correlation group operation

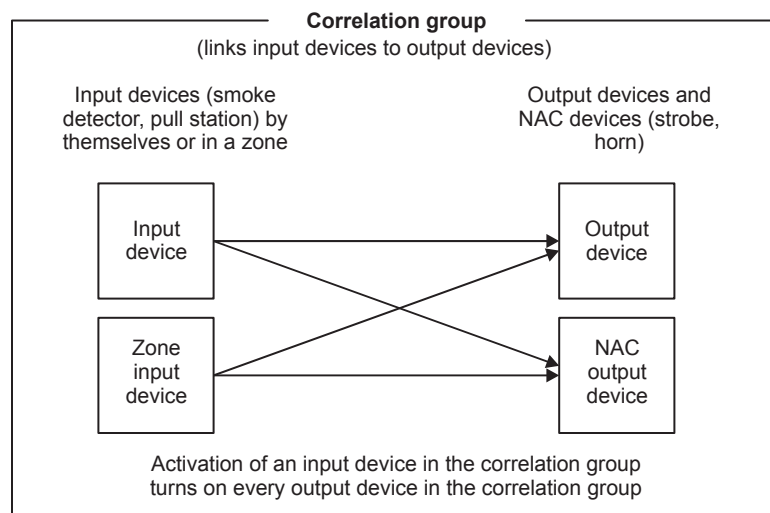

A correlation group can contain any combination of input devices, output devices, NACs, and zones. Input devices, output devices, NACs, and zones can be assigned to more than one correlation group. There are 199 available correlation groups.

Figure 44: Inputs and outputs to correlation groups

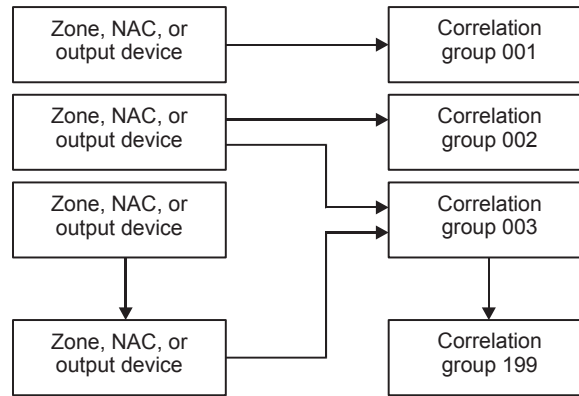

Note: By default, NACs, zones, and devices are assigned to correlation group 001, except for relay and sounder bases, which are not automatically assigned to correlation groups.

What is in-suite signal silence?

In-suite signal silence is a form of automatic alarm silencing that can be enabled for correlation groups. The function is used in residential complexes to minimize the annoyance of false alarms within living quarters. When an alarm input device activates, evacuation signals activate normally. After a minute, alarms in living quarters outside the alarm zone deactivate briefly, which gives building personnel time to investigate the problem. Room and hallway evacuation signals in the alarm zone and hallway signals throughout the building remain active.

If the alarm has not been cleared within 1 to 10 minutes, or if a subsequent alarm occurs, all signals resound. The shutdown period can be adjusted at the panel. In-suite signal silence can be turned off completely at the panel by setting the Suite Signal Silence option to Off. This setting is found at Program > Advanced Program > Panel Operation.

Notes

- Only alarm events can initiate in-suite signal silence.
- Only the first alarm is silenced by in-suite signal silence. Any additional alarms sound as programmed and are not automatically silenced.
- In-suite signal silence applies only to output devices and NACs that are configured as silenceable. It cannot be used in local alarm signaling applications.

- No special hardware is required.
- In-suite signal silence is required by Ontario Building Code 3.2.4. For instructions on programming in-suite signal silence in a typical system, see “Programming in-suite signal silence” on page 83.

Programming modes

You can choose from three levels of program automation: Auto programming, incremental programming, or advanced programming. These are discussed in the following sections.

Auto programming

The Auto Program command is used to automatically configure the control panel and remote annunciators from their respective front panels.

Auto programming replaces the existing project database with a default project database based on the hardware configuration that it detects. The default project database configures the system as a general fire alarm system that activates all notification appliance circuits when any fire alarm input is activated.

Auto programming can also be used as a first step, to be followed by some advanced programming to customize individual settings. The Auto Program command lets you choose:

- Automatic zone assignments
- The event notification level to use
- Manual or automatic device and zone labeling during auto programming
- The base Follow option for relay and sounder bases
- CMS network and dialer options

Note: Auto programming a previously programmed system, overwrites the current configuration.

To auto program a panel, see “Auto programming the panel” on page 56.

Incremental programming

The Incremental Program command is used to make changes to a panel that has already been programmed. Incremental programming lets you add and label devices and zones in the existing database without affecting any other settings. Incremental programming is typically used to add or remove an additional loop of devices or a large number of devices to the system. See “Performing incremental programming” on page 64.

The Unconfigured Alarm command is used to add an additional device or several devices to a system without using the Incremental Program command. When a new

device is added or a device is removed, the panel signals a “trouble active” event and indicates on the LCD that there is an unconfigured device. The device can then be programmed and added to the database. This method is typically used to add just a few devices. See “Adding and removing devices from programmed systems” on page 67.

Advanced programming

Advanced programming is used to apply custom programming to a new or previously programmed fire alarm system. Advanced programming lets you configure each option individually. See “Labeling zones” on page 67.

Using the programming control buttons

The following buttons are used with the LCD to program the panel.

Table 7: Programming control buttons

Button	Description
Arrow buttons	<p>Right arrow: Displays a sub menu, or toggles between multiple settings such as “Yes” and “No”.</p> <p>Left arrow: Scrolls through a programming option’s selections</p> <p>Up arrow: Moves the cursor up</p> <p>Down arrow: Moves the cursor down</p>
Menu button	Opens and closes the main menu
Enter button	Executes a command, displays a sub menu, displays the Save function, or scrolls through a programming option’s selections.
Alphanumeric Keypad	Used to enter numbers and letters needed for the various settings. Pressing and holding a key scrolls through alternate values. For example, pressing and holding the “2” key scrolls between 2, A, B, and C.
Cancel button	Returns to the previous menu level. Exits menu mode if you are at the highest menu level. Deletes text when editing labels, etc.

Factory default settings

The panel is shipped from the factory with default settings. You can accept or change these settings as needed.

Note: Depending on panel equipment and programming, some of these settings may not be available.

Default passwords

The panel comes standard with a set of default passwords. These are:

- Level 1: 1111
- Level 2: 2222
- Remote annunciator: 3333

Note: It is recommended that you change the default passwords before programming the system.

Default panel operation settings

- Language: English
- Marketplace: US
- AC fail delay: 3 hours
- Zone resound: On
- Reset inhibit: Off
- Auto signal silence: Off
- Suite signal silence: 10 minutes
- Day start: 06:00
- Night start: 18:00
- Date format U.S.: MM/DD/YYYY
- Aux power reset: On
- LCD banner: Blank
- Event notification: Device
- Key #1: Disabled
- Key #2: Disabled

Other default panel settings

- Daylight savings
 - Enabled: No
 - Month start: 03
 - Month end: 11
 - Week start: 1
 - Week end: 0
 - Weekday start: 0
 - Weekday end: 0
 - Hour start: 02
 - Hour end: 02
 - Offset minutes: 60
- RS232 CU Enable: Off
- Lock remote read: No

Default panel configuration settings

- IP: 192.168.001.003
- Subnet mask: 255.255.255.0
- Gateway: 000.000.000.000
- Panel NACs
 - Class: Class B
 - Type: Genesis - audible visible silence
 - Correlation group: 1

- Event notification
 - Trouble > Printer: Yes
 - Trouble > Dialer: Acct 1
 - Trouble > NET: Yes
 - Trouble > CID: 321 (NAC1), 322 (NAC2), 326 (NAC3), 327 (NAC4)
 - Disable > Printer: Yes
 - Disable > Dialer: Acct 1
 - Annunciator class: Class B
 - Annunciators
 - Type: Off
 - Number expanders: None
 - Event notification
 - Trouble > Printer: Yes
 - Trouble > Dialer: Acct 1
 - Trouble > NET: Yes
 - Trouble > CID: 334
 - Swinger shutdown: Off
 - CMS device
 - Dialer
 - Type: Dual line
 - Acct 1 and 2
 - Account ID: FFFF
 - Primary receiver #: Blank
 - Secondary receiver #: Blank
 - Format: CID
 - Line 1 and 2
 - Dialing: Tone
 - Cut Duration/supervision: 120 sec.
 - Tone wait: 10 seconds
 - Call disconnect seconds: Off
 - Test frequency days: 1
 - Printer
 - Type: Unsupervised
 - Event notification
 - Trouble > Printer: Yes
 - Trouble > Coder: 00-00-00-00
 - Trouble > Dialer: Acct 1
 - Trouble > NET: Yes
 - Trouble > CID: 336
 - Lock remote read: No
 - AC voltage: 120
 - Network (receiver)
 - Enabled: No
 - Account ID: FFFF
 - IP: 192.168.1.254
 - TCP/IP port: 9999
 - Send restorals: Yes
- Disable > NET: Yes
 Disable > CID: 521 (NAC1), 522 (NAC2), 526 (NAC3), 527 (NAC4)
 Test > Printer: Yes
 Test > Dialer: Acct 1
 Test > NET: Yes
 Test > CID: 600
- Send restorals: Yes
 Retry time: 5 seconds
 Retry count: 5
 Event notification: Device
- Test time: 03:11
 Rings to answer: 5
 Ring type: Any
 Callback: Disabled
 Callback #: Blank
- Event notification: Device
 Hello time: 25
 Timeout: 40
 Receiver #: 2
 Line #: 2

Default loop configuration settings

- Loop class: Class B
- Zone
 - Type: Alarm
 - Correlation group: 001
 - Notes
 - By default, NACs, zones, and most devices are assigned to correlation group 001.
 - Relay and sounder bases with the Follow option set to Head are not automatically assigned to correlation groups.
 - Event notification

<ul style="list-style-type: none"> Active > Printer: Yes Active > Dialer: Acct 1 Active > NET: Yes Active > CID: 110 Trouble > Printer: Yes Trouble > Dialer: Acct 1 Trouble > NET: Yes Trouble > CID: 373 Disable > Printer: Yes Disable > Dialer: Acct 1 Disable > NET: Yes Disable > CID: 570 Pre alarm > Printer: Yes Pre alarm > Dialer: None 	<ul style="list-style-type: none"> Pre alarm > NET: No Pre alarm > CID: 118 Alarm verify > Printer: Yes Alarm verify > Dialer: None Alarm verify > NET: No Alarm verify > CID: 118 Maintenance alert > Printer: Yes Maintenance alert > Dialer: Acct 1 Maintenance alert > NET: Yes Maintenance alert > CID: 393 Test > Printer: Yes Test > Dialer: Acct 1 Test > NET: Yes Test > CID: 614
--	--
- Device

<ul style="list-style-type: none"> Day sensitivity: Least Night sensitivity: Least Day prealarm %: Off Night prealarm %: Off Base follow: Alarm Event notification <ul style="list-style-type: none"> Active > Printer: Yes Active > Coder: 00-00-00-00 Active > Dialer: Acct 1 Active > NET: Yes Active > CID: 110 Trouble > Printer: Yes Trouble > Dialer: Acct 1 Trouble > NET: Yes Trouble > CID: 373 Disable > Printer: Yes Disable > Dialer: Acct 1 Disable > NET: Yes Disable > CID: 570 Pre alarm > Printer: Yes Pre alarm > Coder: 00-00-00-00 Pre alarm > Dialer: None Pre alarm > NET: No Pre alarm > CID: 118 	<ul style="list-style-type: none"> Type (input device): Depends on type of device and marketplace Type (output device): Genesis with audible/visible silence Correlation group: 1 Alarm verify > Printer: Yes Alarm verify > Coder: 00-00-00-00 Alarm verify > Dialer: None Alarm verify > NET: No Alarm verify > CID: 118 Maintenance alert > Printer: Yes Maintenance alert > Coder: 00-00-00-00 Maintenance alert > Dialer: Acct 1 Maintenance alert > NET: Yes Maintenance alert > CID: 393 Test > Printer: Yes Test > Coder: 00-00-00-00 Test > Dialer: Acct 1 Test > NET: Yes Test > CID: 614
--	--

- Mapping: No
- Loop 2 enable: No
- Loop 2 Fst Grp: 1 to 25

Default contact ID event codes

Contact ID codes are used to report events that take place in the fire alarm system to a central monitoring station (CMS) via a dialer or over a network. The following table lists the default Contact ID (CID) codes for panel and loop events. Some events do not have CID codes. You can change the default code for an event or assign a code to an event that does not have one. See “Event programming” on page 120.

Table 8: Contact ID event codes

Event	CID	Event	CID
AC power (disable)	500	Date	625
AC power (trouble)	301	Device trouble	373
Alarm active	110	Device disable	570
Annunciator trouble	334	Device pre alarm	118
Aux. power 1 (disable)	500	Device alarm verify	118
Aux. power 1 (trouble)	312	Device maintenance alert	393
Aux. power 2 (disable)	500	Device test	614
Aux. power 2 (trouble)	312	Dialer disable/remote disconnect	551
Battery charger (disable)	500	Dialer line 1 fault (disable)	500
Battery charger (trouble)	309	Dialer line 1 fault (trouble)	351
Battery low (disable)	500	Dialer line 2 fault (disable)	500
Battery low (trouble)	302	Dialer line 2 fault (trouble)	352
Battery missing (disable)	500	Dialer deliver fail	354
Battery missing (trouble)	311	Dialer normal test	602
Clear history	621	Dialer abnormal test	608
Common alarm	110	Dialer configuration	354
Common disable	500	Drill	601
Common monitor	140	Duct active	116
Common supervisory	200	Ground fault (disable)	500
Common trouble	373	Ground fault (trouble)	310
Common trouble for network dialer	373	Heat active	114
Common trouble for telco dialer	373	Internal fault	307

Event	CID	Event	CID
Loop 1 initialization	000	NAC4 trouble	327
Loop 1 fault (disable)	500	NAC1 disable	521
Loop 1 fault (trouble)	331	NAC2 disable	522
Loop 1 map fault	331	NAC3 disable	526
Loop 1 card fault (disable)	500	NAC4 disable	527
Loop 1 card fault (trouble)	333	NAC test	600
Loop 1 Uncfgrd alarm (disable)	500	Net rcvr conf fault	354
Loop 1 Uncfgrd alarm (active)	110	Net rcvr comm fault (disable)	500
Loop 1 Uncfgrd trbl (disable)	500	Outputs are latched	140
Loop 1 Uncfgrd trbl (trouble)	331	Net rcvr comm fault (trouble)	354
Loop 1 map mismatch	331	Panel silence	315
Loop 1 over limits	331	Printer trouble	336
Loop 1 address zero	331	Program mode	627
Loop 1 mapping	000	Pull active	115
Loop 2 initialization	000	Reset	305
Loop 2 fault (disable)	500	Reset/Silence inhibit	000
Loop 2 fault (trouble)	331	Self test fault	307
Loop 2 map fault	331	Signal silence	328
Loop 2 card fault (disable)	500	Smoke active	111
Loop 2 card fault (trouble)	333	Smoke/Heat active	111
Loop 2 Uncfgrd alarm (disable)	500	Supervisory active	200
Loop 2 Uncfgrd alarm (active)	110	System startup	000
Loop 2 Uncfgrd trbl (disable)	500	System AC power (disable)	500
Loop 2 Uncfgrd trbl (trouble)	331	System AC power (trouble)	301
Loop 2 map mismatch	331	Test fire	604
Loop 2 over limits	331	Time	625
Loop 2 address zero	331	Walk test	607
Loop 2 mapping	000	Waterflow active	113
Monitor active	140	Zone active	110
NAC1 trouble	321	Zone trouble	373
NAC2 trouble	322	Zone disable	570
NAC3 trouble	326		

Event	CID
Zone pre alarm	118
Zone alarm verify	118
Zone maintenance alert	393
Zone test	614

Device type descriptions

Device types determine the operation of the points to which they are assigned. The following tables contain all possible device types. Available device types depend on the device and on the marketplace selected for the panel. Some device types are unavailable in some marketplaces. For this reason, the LCD listing for the selected device may differ from this table.

Note: To correlate device types with personality codes when programming Signature Series devices, see Appendix E “Device types to personality codes correlation” on page 257.

Table 9: Alarm device types

Device type	Description
Photo detectors	
Smoke	For smoke detectors and contact devices. All activations are immediately considered as alarms. Circuit cannot be restored until devices are restored to normal and the panel is reset.
Smoke verified	For smoke detectors and contact devices. Two-wire smoke detector activations are verified (delayed and confirmed) before activating an alarm. Four-wire smoke detectors and contact devices are not verified and immediately considered as alarms. Circuit cannot be restored until devices are restored to normal and the panel is reset.
Supervisory latching	For detectors that trigger an active (supervisory) event. Detectors with this device type remain active until the condition that activated them is restored and the control panel is reset.
Supervisory nonlatching	For detectors that trigger an active (supervisory) event. Detectors with this device type remain active until the condition that activated them is restored. Resetting the control panel is not required.
Ion detectors	
Smoke	For smoke detectors and contact devices. All activations are immediately considered as alarms. Circuit cannot be restored until devices are restored to normal and the panel is reset.

Device type	Description
Smoke verified	For smoke detectors and contact devices. Two-wire smoke detector activations are verified (delayed and confirmed) before activating an alarm. Four-wire smoke detectors and contact devices are not verified and immediately considered as alarms. Circuit cannot be restored until devices are restored to normal and the panel is reset.
Supervisory latching	For detectors that trigger an active (supervisory) event. Detectors with this device type remain active until the condition that activated them is restored and the control panel is reset.
Supervisory nonlatching	For detectors that trigger an active (supervisory) event. Detectors with this device type remain active until the condition that activated them is restored. Resetting the control panel is not required.
Duct detectors	
Duct alarm	For duct smoke detectors. All activations are immediately considered as alarms. Circuit cannot be restored until devices are restored to normal and the panel is reset.
Duct supervisory (latching and nonlatching)	For duct supervisory devices. Momentary activation of normally open devices immediately places the panel in a supervisory state and turns on supervisory LEDs and relays. Circuit cannot be restored until devices are restored to normal and the panel is reset.
Heat detectors	
Heat alarm	For heat detectors and contact devices. All activations are immediately considered as alarms. Circuit cannot be restored until devices are restored to normal and the panel is reset.
Heat alarm RoR	For heat detectors and contact devices with rate-of-rise. All activations are immediately considered as alarms. Circuit cannot be restored until devices are restored to normal and the panel is reset.

Table 10: Input module device types

Device type	Description
2Wire Class A	Allows for the monitoring of two-wire conventional smoke detectors in a Class A circuit (that do not require alarm verification) and normally open contact initiating devices on the same circuit.
2Wire Class B	Allows for the monitoring of two-wire conventional smoke detectors in a Class B circuit (that do not require alarm verification) and normally open contact initiating devices on the same circuit
2Wire verify Class A	Allows for the monitoring of two-wire conventional smoke detectors in a Class A circuit (that require alarm verification)
2Wire verify Class B	Allows for the monitoring of two-wire conventional smoke detectors in a Class B circuit (that require alarm verification)
Alarm	For smoke detectors and contact devices. All activations are immediately considered as alarms. Circuit cannot be restored until devices are restored to normal and the panel is reset.

Device type	Description
Duct alarm	For duct smoke detectors. All activations are immediately considered as alarms. Circuit cannot be restored until devices are restored to normal and the panel is reset.
Heat	For heat detectors and contact devices. All activations are immediately considered as alarms. Circuit cannot be restored until devices are restored to normal and the panel is reset.
Pull station	For pull station devices. All activations are immediately considered as alarms.
Remote drill	For a remote switch that when activated, starts the panel's drill operation.
Remote reset	For a remote switch that when activated, resets the panel.
Remote signal silence	For a remote switch that when activated, silences the signaling devices.
Waterflow	For connecting vane type and pressure flow switches. Activations are considered as alarms. A 16-second alarm delay applies to waterflow activations. Circuit cannot be restored until devices are restored to normal and the panel is reset. Waterflow activations do not invoke in-suite signal silence.

Table 11: Supervisory device types

Device types	Description
Duct supervisory (latching and nonlatching)	For duct supervisory devices. Momentary activation of normally open devices immediately places the panel in a supervisory state and turns on supervisory LEDs and relays. Circuit cannot be restored until devices are restored to normal and the panel is reset.
Supervisory latching	For supervisory devices. Momentary activation of normally open devices immediately places the panel in a supervisory state and turns on supervisory LEDs and relays. Circuit cannot be restored until devices are restored to normal and the panel is reset.
Supervisory nonlatching	For supervisory devices. Momentary activation of normally open devices immediately places the panel in a supervisory state and turns on the supervisory LED and relay. Annunciation remains active until the input restores. The panel does not have to be reset.

Table 12: Trouble device types

Device type	Description
Remote AC fail	For use with auxiliary power supplies to provide AC Fail indication to the fire panel. The fire panel treats this activation as if the panel itself detected an AC fail condition. Delays off-premises signaling for the selected time duration.

Table 13: Monitor device types

Device type	Description
Monitor	Monitoring of normally open switches for other functions (fire door position, etc.). Not approved for use under ULC 527 in Canada.

Table 14: Output device types

Device type	Description
Continuous nonsilenceable	For nonsilenceable strobes and notification appliances that self-generate a temporal pattern
Continuous nonsilenceable (latched)	For latching strobes and notification appliances that self-generate a temporal pattern
Duct alarm	For duct smoke detectors. All activations are immediately considered as alarms. Circuit cannot be restored until devices are restored to normal and the panel is reset.
Duct supervisory (latching and nonlatching)	For duct supervisory devices. Momentary activation of normally open devices immediately places the panel in a supervisory state and turns on supervisory LEDs and relays. Circuit cannot be restored until devices are restored to normal and the panel is reset.
Continuous silenceable	For strobes and notification appliances that self generate a noncoded tone
Genesis audible visible silence	For Genesis and Enhanced Integrity horns and strobes. Genesis and Enhanced Integrity appliances maintain synchronization per UL 1971. For Genesis devices only, connected horns can be silenced and strobes turn off.
Genesis nonsilenceable	For Genesis and Enhanced Integrity horns and strobes. Genesis and Enhanced Integrity appliances maintain synchronization per UL 1971. For Genesis devices only, connected horns cannot be silenced and strobes on the same two-wire circuit flash until the panel is reset.
Monitor	Monitor: Monitoring of normally open switches for other functions (fire door position, etc.). Not approved for use under ULC 527 in Canada.
Relay nonsilence NC	For relay devices that open when activated and remain open when you press Signal Silence.
Relay nonsilence NC (latched)	For latching relay devices that open when activated and remain open when you press Signal Silence.
Relay nonsilence NO	For relay devices that close when activated and remain closed when you press Signal Silence.
Relay nonsilence NO (latched)	For latching relay devices that close when activated and remain closed when you press Signal Silence.
Relay nonsilenceable	For relay devices that do not follow signal silence
Relay nonsilenceable (latched)	For relay devices that do not follow signal silence and do not restore until manually unlatched
Relay silence	For relays that turn off when you press Signal Silence.

Device type	Description
Relay silence NC	For relays that open when activated and close when you press Signal Silence.
Relay silence NO	For relays that close when activated and open when you press Signal Silence.
Supervised output	For modules that output an unsynchronized signal and that do not turn off when you press Signal Silence.
Supervised output (latched)	For latched output modules that output an unsynchronized signal and that do not turn off when you press Signal Silence.
Unlatch outputs	For output modules that are configured to manually unlatch latched outputs [1]

[1] The following output modules can be configured to unlatch latched outputs: SIGA-CT1, SIGA-CT2, SIGA-MAB, SIGA-MCT2, SIGA-MM1, and SIGA-UM.

Table 15: Latched output device types [1]

Device type	Description
Continuous Non-Silenceable (Latched)	For Class B latched output modules that output an unsynchronized signal. Does not follow signal silence.
Continuous Non-Silenceable Class A (Latched)	For Class A latched output modules that output an unsynchronized signal. Does not follow Signal Silence.
Relay Non-Silence NC (Latched)	For relay devices functioning as latched output devices that open when activated. Does not follow signal silence.
Relay Non-Silence NO (Latched) Latch	For relay devices functioning as latched output devices that close when activated. Does not follow signal silence.
Relay Non-Silenceable (Latched)	For Class B relay devices functioning as latched output devices. Does not follow signal silence.
Supervised Output (Latched)	For Class B latched output modules that output an unsynchronized signal. Does not follow signal silence.
Supervised Outputs Class A (Latched)	For Class A latched output modules that output an unsynchronized signal. Does not follow Signal Silence.

[1] Table 24 on page 96 gives a full list of devices configurable as latched output devices.

Displaying the Program menu

1. Press the Menu button.
2. Choose Program.
3. Press Enter.

Setting the time and date

The first step in programming the panel is setting the time and date. You must do this before using either the Auto Program or Advanced Program command.

To set the time and date:

1. Press the menu button and choose Program.
2. Choose Date and Time.
3. Enter a level one password.
4. Enter the current date.
5. Enter the current time.
6. Choose Save.
7. Press the Menu button to exit menu mode, or continue programming.

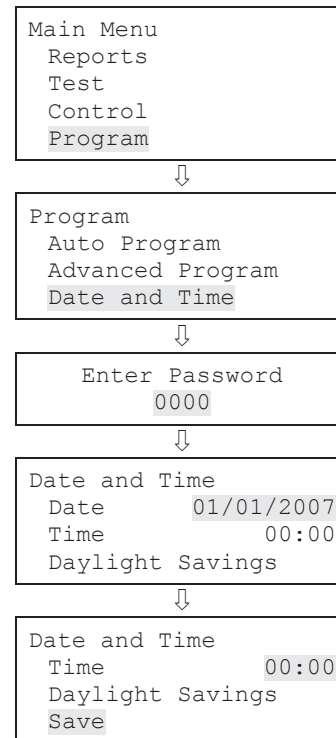

Setting daylight saving time

Daylight saving time options allow the panel to switch automatically from standard to daylight saving time and vice versa.

To program daylight saving time options:

1. Display the Program menu and choose Date and Time.
2. Enter a level one password.
3. Choose Daylight Savings.
4. Choose one of the following:
 - Yes: The panel recognizes daylight saving time
 - No: The panel does not recognize daylight saving time
5. Set the Month Start. (Values range from 01 to 12, where 01 corresponds to January.)
6. Set the Month End. (Values range from 01 to 12.)
7. Set the Week Start. (Values range from 1 to 5, where 5 corresponds to the last week of the month.)
8. Set the Week End. (Values range from 1 to 5, where 5 corresponds to the last week of the month.)
9. Set the Weekday Start. (Values range from 1 to 7, where 1 corresponds to Sunday.)
10. Set the Weekday End.
11. Set the Hour Start. (Values range from 00 to 23, where 00 corresponds to 12 midnight.)
12. Set the Hour End. (Values range from 00 to 23.)
13. Set the Minutes Offset. (Values range from 0 to 255.).
This controls the number of minutes the clock will adjust when daylight saving time begins and ends. The default is 60 minutes.
14. Press Enter, then choose Save.
15. Press the Menu button to exit menu mode, or continue programming.

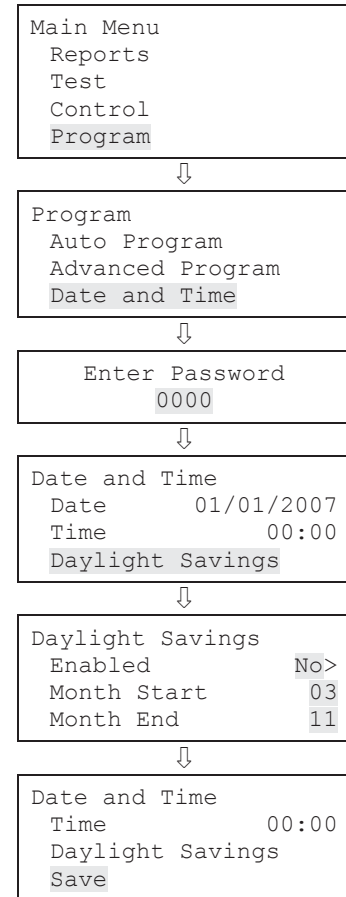

Sample values for daylight saving time

The values in the following table would:

- Start daylight saving time at 2:00 a.m. on Sunday, the second week of March
- Return to standard time at 2:00 a.m. on Sunday, the first week in November
- Adjust the time by 60 minutes (1 hour) each time

Table 16: Sample values for daylight saving time

Month start:	03
Week start:	2
Week day start:	1
Hour start:	02
Month end:	11
Week end:	1
Week day end:	1
Hour end:	02
Offset minutes:	60

Changing the passwords

The second step in programming the panel is to change the level one, level two, and remote annunciator passwords.

Notes

- It is recommended that you change the default passwords before programming the system.
- The system will automatically log you out after four minutes of inactivity.

To change the passwords:

1. Press the menu button and choose Program.
2. Choose Password.
3. Enter a level two password.
4. Select the password to be changed: Level 1, Level 2, or Remote (Ann.).
5. Enter the old password and press Enter.
6. Enter the new password and press Enter.
7. Repeat steps 4 through 6 for each password to be changed.
8. Press the Menu button to exit menu mode, or continue programming.

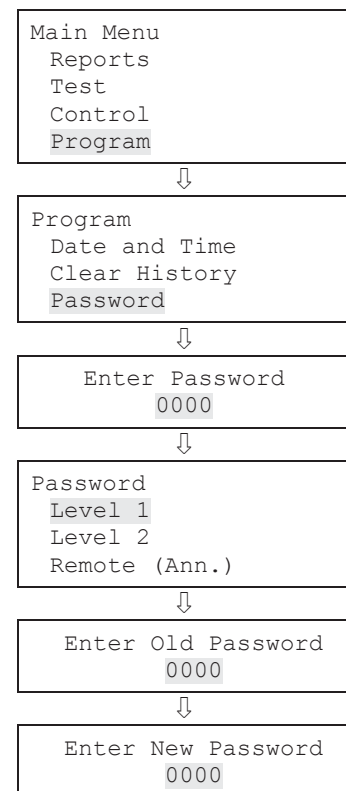

Restoring the factory default settings

Use the Restore Defaults command to overwrite most custom settings in the panel, the dialer (CMS network), or both. This lets you commission the panel as a common alarm system or to remove custom settings in preparation for advanced programming.

Note: The current language, marketplace, and loop device configuration settings are *not* affected by the Restore Defaults command.

To restore the default settings:

1. Press the menu button and choose Program.
2. Choose Restore Defaults.
3. Enter a level two password.
4. Select either Panel Only, CMS Only, or Panel and CMS.

Panel only: Restores only the panel's defaults (panel operation options and panel configuration options)

CMS only: Restores only the dialer, network, and swinger shutdown defaults

Panel and CMS: Restores both the panel and CMS device defaults

5. Press Enter.
6. Return to the Program menu.
7. Choose Panel Restart.
8. Choose Yes.

The panel restarts, and the factory default settings are reloaded into the database.

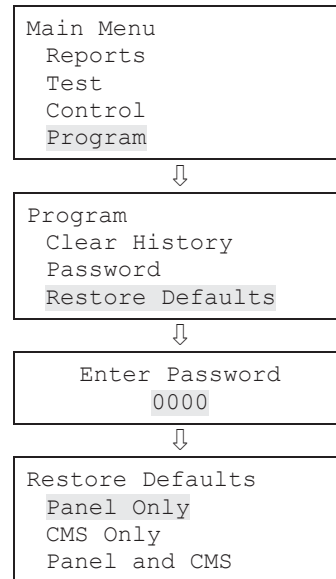

Setting up the programmable keys

There are two control panel buttons that can be assigned to correlation groups in order to:

- Disable and reen able panel NACs, devices, and zones
- Activate panel NACs and devices
- Restore panel NACs and devices
- Unlatch all output devices globally

By default, the buttons are not programmed. The buttons can be labeled to indicate their function with a slip-in label. To operate the buttons, you must be logged on with a level one password or greater.

Figure 45: Programmable keys

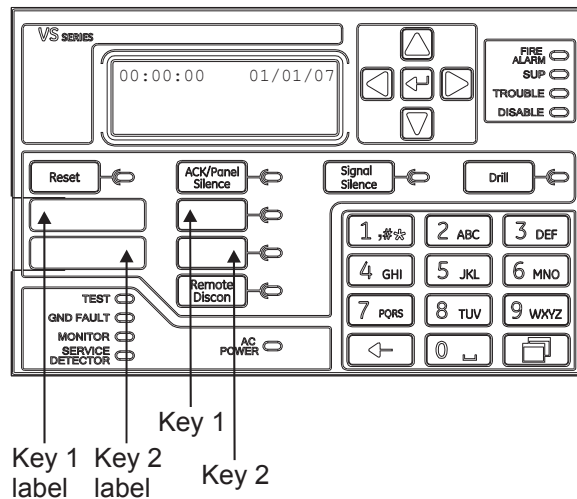

Note: You cannot program a key while it is active. If the “Key is active” message is displayed, wait until the key deactivates.

To set up a programmable key:

1. Press the menu button and choose Program.
2. Choose Programmable Keys.
3. Enter a level two password.
4. Choose the key to be programmed.
5. Choose Edit List or New List. Both commands let you select a function and edit the list of correlation groups assigned to the key. The difference between the two is that:
 - Edit List lets you makes changes to a key that has already been programmed. Choose this command to change the key’s function, or edit the list of correlation groups assigned to it.

Note: If you select Edit List for a key that has not yet been programmed, the message “Nothing to Edit” is displayed. Choose New List instead.

 - New List can be used to set up a new programmable key or to overwrite the current programming of a key that has already been set up.
6. Choose a function to assign to the key.

None Unlatch
 Activate Restore
 Disable

Note: To disable a programmed key, choose None.

7. If you chose Unlatch in step 6:
 - Press Enter.
 - Press the Cancel button to reopen the previous menu, then choose Save.

— or —

Press the menu button to exit menu mode.

The button is now completely programmed to unlatch all latched outputs globally.

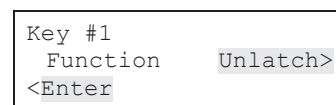
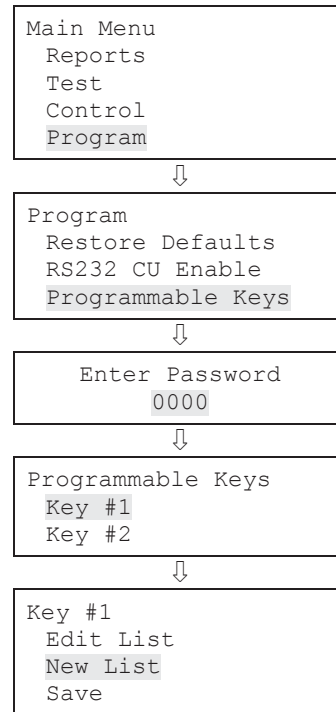

8. If you chose Disable, press the down arrow to edit the Control option, and indicate what the key should control. Choose:

- Members
- Corr Grp
- Both

Note: This option is not available for Unlatch, Activate, or Restore.

You are now ready to choose the correlation groups to be activated, disabled, or restored.

9. Enter the number of the first correlation group to be assigned or unassigned, then press Enter.
- If you enter the number of a correlation group that is already assigned to the key, the command REM (remove) is displayed. Pressing Enter removes the group from the list.
 - If you enter the number of a correlation group that has not yet been assigned to the key, the command ADD is displayed. Pressing Enter to adds the new group to the list.

10. Enter the number of the next correlation group to be added or removed, then press Enter. Repeat to add or remove any remaining correlation groups.
11. When you have finished editing the list of correlation groups, press the Cancel button to reopen the previous menu, then choose Save.

— or —

Press the menu button to cancel your changes and exit menu mode.

12. Press the menu button to exit menu mode. The button is now programmed to activate, disable, or restore all correlation groups that you have added to the list.

```

Enter to      Add<>
Corr Grp      001
Control       Corr Grp
<Back        <Enter

```

— or —

```

Enter to      Add<>
Corr Grp      001
Control       Members
<Back        <Enter

```

— or —

```

Enter to      Add<>
Corr Grp      001
Control       Both
<Back        <Enter

```

↓

```

Enter to      Add<>
Corr Grp      001
Control       Corr Grp
<Back        <Enter

```

— or —

```

Enter to      Add<>
Corr Grp      001
Control       Members
<Back        <Enter

```

Clearing the event history log

The panel maintains a log of 1,000 system or user events. The event record contains the event time, the event type, the event state, and the event ID. The event time is the time and date of the event activation or restoration. All of these records are stored in the panel's history database and can be cleared (deleted) if needed.

Once the history log is cleared, all new panel events are stored in history. You might want to clear the history log in the following situations:

- When installation is complete, you can clear the history log before turning the system over to the building owner.
- If the system history log is filled with event records resulting from a faulty device, problem, or situation, you can clear the history log after the problem is addressed.

Note: When the history log is full, the oldest event is deleted when a new event is added.

To clear the event history log:

1. Press the menu button and choose Program.
2. Choose Clear History.
3. Enter a level two password.
4. Select Yes to clear history or No to leave history unchanged.
5. Press Enter.
6. Press the Menu button to exit menu mode, or continue programming.

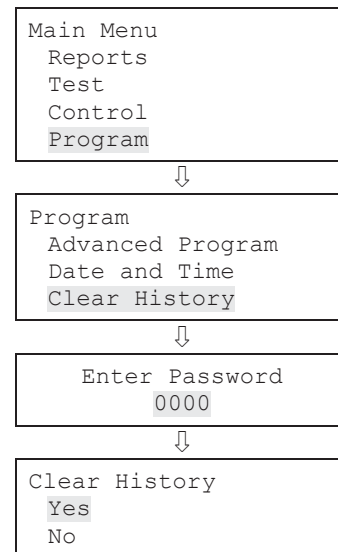

Restarting the panel

The Panel Restart command restarts (reboots) the panel without having to cycle AC power.

To restart the panel:

1. Press the menu button and choose Program.
2. Choose Panel Restart.
3. Enter your level two password (or greater).
4. Choose Yes to restart the panel.
 - or —
 - Choose No to cancel.

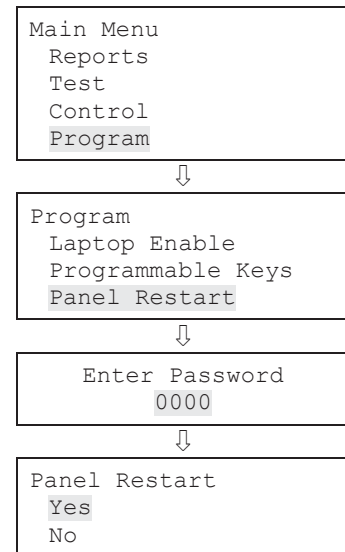

Enabling RS232 communication

The RS232 CU Enable command lets you connect a PC to the control panel by means of the optional RS232 card. This enables you to use the Configuration Utility (CU) to program the panel and upload or download panel data.

Note: The RS232 CU Enable command times out (turns off) after four minutes of inactivity, meaning that if the command is enabled but does not connect to the CU PC within four minutes, the command turns off and must be reenabled.

To enable RS232 communication:

1. If you are using a printer, disconnect the printer cable from the RS-232 card.
2. Connect the configuration utility computer to the RS-232 card.
3. Press the menu button and choose Program.
4. Choose RS232 CU Enable.

The RS232 CU Enable screen is displayed.

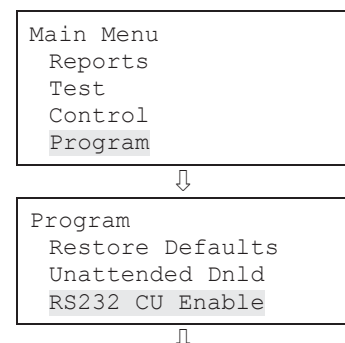

5. Choose On.

The panel can now communicate with the CU.

RS232 CU Enable
On
Off

6. When you have finished, disconnect the PC from the RS-232 card.

7. Turn off RS232 CU Enable.

8. Reconnect the printer cable to the RS-232 card if needed.

Auto programming the panel

Auto programming detects and applies default settings to installed devices, NACs, remote annunciators, and expansion cards. You can control many aspects of the process by programming the options listed in:

- “Auto programming options” on page 57
- “Dialer options” on page 59
- “NET options” on page 61

Auto programming sets up a common alarm system. After the auto programming process has finished, you can continue with advanced programming to apply any custom settings that may be required.

Caution: Auto programming replaces the current settings for devices, NACs, remote annunciators, and expansion cards with default settings.

Notes

- Before starting the auto programming sequence, set the time and date and change the default passwords. “Factory default settings” on page 35 for a list of all the settings that will be applied during auto programming.
- Auto programming places most input devices and NACs in correlation group 001. Relay and sounder bases are not automatically assigned to correlation groups. For more information on correlation groups, see “What is a correlation group?” on page 32 and “Correlation group programming” on page 79.
- Auto programming turns off the In Suite Signal Silence option for all correlation groups.
- If you choose to label devices during auto programming, devices are labeled by entering the address of the device and then labeling the device. It is important for you to have a printout of the Device Details > Serial Number report to correlate

the device address with the default label and serial number. This will make device labeling much easier.

Auto programming options

Table 17 below describes the options to be set when auto programming the panel.

Table 17: Auto programming options [1]

Option	Description
Auto zoning	<p>This option controls whether devices are automatically assigned to zones. The number of devices assigned to a zone is based on the type of panel:</p> <ul style="list-style-type: none"> • VS1 panel: Four devices per zone • VS2 panel: Sixteen devices per zone <p>Yes: The system automatically finds all of the devices connected to the system and assigns them to a zone.</p> <p>No: The system automatically finds all of the devices connected to the system and does not assign them to a zone</p>
Enable NET	<p>Configures the panel to communicate with a central monitoring station (CMS) via an Ethernet network.</p> <p>Yes: Enables Ethernet communication with the central monitoring station (CMS).</p> <p>No: Disables Ethernet communication with the CMS.</p>
Dialer	<p>Configures the panel to communicate with the CMS via a dialer. The dialer is configured as a dual line so that all messages are sent to two separate receivers with different phone numbers and account codes.</p> <p>Note: Not all dialer programming options are acceptable for UL/ULC installations. See “UL 864 programming requirements” on page 31 for details.</p> <p>Yes: Enables the dialer and configures it for dual-line communication with the CMS. All messages will be sent to two separate receivers that have different phone numbers and account codes.</p> <p>No: Dialer is not enabled.</p>
Event notification	<p>Configures event reporting for zones, individual devices, or both.</p> <p>Zone: When a device is a member of a zone, only the zone information is sent to the LCD, LEDs, printer, and dialer. Note: Device level reporting configuration is not available.</p> <p>Zone/device: Zone information is sent to the LCD and LEDs. Device information is sent to the printer and dialer. Note: Zone/device reporting locations can be configured through custom programming.</p> <p>Device: Only device information is reported, no zone information</p>

Option	Description
Label devices	<p>Configures the auto programming sequence to allow you to label devices using the alphanumeric keypad.</p> <p>Yes: Enables device labeling</p> <p>No: Disables device labeling</p>
Label zones	<p>Configures the auto programming sequence to allow you to label zones using the alphanumeric keypad.</p> <p>Yes: Enables zone labeling</p> <p>No: Disables zone labeling</p>
Follow	<p>This option controls the conditions that will activate relay or sounder detector bases. Select from the following values:</p> <p>Head: The base is controlled by the detector's settings.</p> <ul style="list-style-type: none"> • The base activates when the detector goes into alarm, unless the detector is set for alarm verification. • If the detector is set for alarm verification, the base activates when the detector goes into alarm verification. It does not restore, however, until the alarm restores. • The base does not respond when the detector goes into prealarm no matter how the detector is configured. • Devices with the base set to follow "Head" cannot be placed in correlation groups. When a device base is set to follow "Head," the base is removed as an output from any Correlation Groups to which it belongs. <p>Alarm: The base activates its relay when the detector goes into alarm. The base will not restore until the alarm event has been restored.</p> <p>Alarm and verify (ALM+VFY): The base activates its relay when the detector goes into alarm verify and continues when the detector goes into alarm. The base will not restore until both events have been restored.</p> <p>Alarm and prealarm (ALM+PALM): The base activates its relay when the detector goes into prealarm and continues when the detector goes into an alarm. The base will not restore until both events have been restored.</p> <p>Riser: The base is triggered individually by the loop controller (sounder bases only)</p> <p>None: A correlation group triggers the base. It can be applied to both relay and sounder bases and is used for relay bases configured as latched output devices.</p> <p>Note: All base follow settings except "Head" and "Riser" can be activated by correlation groups.</p>

[1] Not all options listed here are displayed on all systems.

Dialer options

Table 18 describes the options used to set up the dialer.

Table 18: Auto programming – Dialer options [1]

Option	Description
Account 1	<p>Account ID: Enter the four-digit ID code for account 1 (Note: If you do not change the default of FFFF, no events will be sent.)</p> <p>Primary receiver number: Enter the primary receiver's phone number. Up to 20 digits (0-9, *, #, and ,). The comma causes a two-second delay in dialing. The number or hash symbol (#) and the asterisk symbol (*) are used with calling feature codes and services. Consult your telephone service provider.</p> <p>Secondary receiver number: Enter the secondary receiver's phone number. Up to 20 digits (0-9, *, #, and ,). The comma causes a two-second delay in dialing.</p> <p>Format: CID</p> <p>CID: Contact ID is the alarm format that the monitoring facility (DACR) will receive. See "Default contact ID event codes" on page 39.</p> <p>Event notification: Set event notification (event reporting) to:</p> <p>Device: Only device information is reported or transmitted, no zone information. Note: This setting uses default device event notification settings for reporting events. See "Factory default settings" on page 35.</p> <p>Zone: When a device is a member of a zone, only the zone information is reported or transmitted, no device information.</p> <p>Note: This setting uses default zone event notification settings for reporting events. See "Factory default settings" on page 35.</p> <p>Event: Only the event type (alarm, supervisory, trouble, etc.) is reported or transmitted, no device or zone information. Note: This setting uses the default CMS event notification settings for reporting events. See "Factory default settings" on page 35.</p>
Account 2	<p>Account ID: Enter four-digit ID code for account 2</p> <p>Primary receiver number: Enter the primary receiver's phone number (up to 20 digits).</p>

```

Account 1
Account ID      6769
Primary Recver# >
Secondary Recver# >
↓
Account 2
Account ID      6769
Primary Recver# >
Secondary Recver# >
↓
Format          CID<>
Event Notif.   Event>
-----
Save

```

Option	Description
	<p>Secondary receiver number: Enter the secondary receiver's phone number (up to 20 digits).</p> <p>Format: CID</p> <p>CID: Contact ID is the alarm format that the monitoring facility (DACR) will receive. See "Default contact ID event codes" on page 39.</p> <p>Event notification: Set event notification (event reporting) to:</p> <p>Device: Only device information is reported or transmitted, no zone information. Note: This setting uses default device event notification settings for reporting events. See "Factory default settings" on page 35.</p> <p>Zone: When a device is a member of a zone, only the zone information is reported or transmitted, no device information. Note: This setting uses default zone event notification settings for reporting events. See "Factory default settings" on page 35.</p> <p>Event: Only the event type (alarm, supervisory, trouble, etc.) is reported or transmitted, no device or zone information. Note: This setting uses the default CMS event notification settings for reporting events. See "Factory default settings" on page 35.</p>

[1] Dialer options are displayed only if a dialer is installed on the panel.

NET options

Table 19 describes the network options used to set up the Ethernet card.

Table 19: Auto programming – NET options

Option	Description
Account ID	Enter the six-digit code for the central monitoring station (CMS) account.
IP	Enter the IP address for the CMS.
Event notification	<p>Set event notification (event reporting) to:</p> <p>Device: Only device information is reported or transmitted, no zone information.</p> <p>Note: This setting uses default device event notification settings for reporting events. See “Factory default settings” on page 35.</p> <p>Zone: When a device is a member of a zone, only the zone information is reported or transmitted, no device information. Note: This setting uses default zone event notification settings for reporting events. See “Factory default settings” on page 35.</p> <p>Event: Only the event type (alarm, supervisory, trouble, etc.) is reported or transmitted, no device or zone information. Note: This setting uses the default CMS event notification settings for reporting events. See “Factory default settings” on page 35.</p>
Receiver number	Enter the CMS receiver number. Specifies the CMS receiver number to be displayed in the message sent to the receiver. This number is user-defined.
Line number	Enter the CMS receiver line number. Specifies the receiver’s line number to be displayed in the message sent to the receiver. This number is user-defined.

```

Network
Account ID      676968
IP      000.000.000.000
Event Notif.  Event>

```

```

Network
Receiver#      000
Line#          000
Save

```

Auto programming procedure

Use the following procedure to auto program the panel, referring to the options listed in Table 17 on page 57. Not all options shown are displayed on all systems.

To auto program a panel:

1. Press the menu button and choose Program.
2. Choose Auto Program.
3. Enter a level two password.
4. When the “Current config. will be lost screen!,” message is displayed on the LCD.
Select Continue to continue with auto programming
— or —
Select Cancel to return to the programming menu.

5. Set auto programming options.
Note: Use the right or left arrow button rather than the Enter button to select values for each option. The Enter button begins the auto programming operation no matter which option the cursor is on. Also, the options you select are preserved and will be displayed the next time you auto program.

6. When you have finished, press Enter.
The panel begins auto programming and displays the number of devices on the system. If you have more than one loop, the device counts are per loop. If you previously programmed the panel, The system displays the number of old and new devices.

7. Press Enter to continue.
Auto programming continues based on the settings you made above.
8. When prompted, program the options you selected using the procedures that follow. For example, if you are using a dialer, auto programming requires you to program specific dialer options.

9. When auto programming is complete, the system displays the banner screen.

```
Main Menu
Reports
Test
Control
Program
```



```
Program
Incremental Program
Auto Program
Advanced Program
```



```
Enter Password
0000
```



```
Current config.
will be lost!
Continue
Cancel
```



```
Auto Program
Auto Zoning      Yes>
Evt Notif       Device>
Label Devices?  Yes>
```



```
Auto Program
System Busy
#####
<Back           <Cancel
```



```
Devices          Old/New
Loop 1           XXX/YYY
Loop 2           XXX/YYY
<Continue
```

— or —

```
Devices:         Old/New
                  XXX/YYY

<Continue
```

Labeling devices

If you set the Label Devices auto programming option to Yes, follow these steps to label the devices.

To label devices:

1. Next to “Device,” enter the device number to be labeled.
2. Enter a text label for the device (two lines of 20 characters). The default label is “Loop X Device XXX.”
3. Press Enter to save the label and go to the next number of the device.

Note: Pressing the Enter button saves the current label and then goes to the next available device so that you can quickly go to each device and label it.

4. Enter a text label for the device (two lines of 20 characters).
5. Repeat steps 3 and 4 until all devices are labeled.
6. When you have finished labeling, place the cursor in the device number field, and press the Cancel button to reopen the previous menu. Continue with the next auto programming option.

```

Loop 1      Device 001
Label goes here
Label continued
<Save      <Back
  
```

See “Programming relay and sounder detector bases” on page 95.

Labeling zones

If you set the Label Zones auto programming option to Yes, follow these steps to label zones.

To label zones:

1. Next to “Zone,” enter the number of the zone to be labeled.
2. Enter a text label for the zone (two lines of 20 characters). The default label is “Zone XX.”
3. Press Enter to save the label and go to the next number of the zone.

Note: Pressing the Enter button saves the current label and then goes to the next zone number so that you can quickly go to each zone and label it.

```

Zone                01>
Label goes here
Label continued
<Save              <Back
  
```

4. Enter a text label for the zone (two lines of 20 characters).
5. Repeat steps 3 and 4 until all zones are labeled.
6. When you finish labeling, make sure the cursor is on the zone number, and press the Cancel button to exit and go to the next auto programming option.

Performing incremental programming

Incremental programming lets you add and label devices and zones to an existing database without affecting current settings. It is typically used to add or remove a device loop or a large number of individual devices. Incremental programming should be used only after the panel has been program either by auto programming or advanced programming.

Incremental programming options

Table 20 below describes the options to be set when performing incremental programming.

Table 20: Incremental programming options

Loop	Select the loop (number) that you want to program, or select All to program all loops.
Label devices	Yes: Enables device labeling No: Disables device labeling
Label zones	Yes: Enables zone labeling No: Disables zone labeling
Follow	This option controls the conditions that will activate relay or sounder detector bases. Select from the following values: Head: The base is controlled by the detector's settings. <ul style="list-style-type: none"> • The base activates when the detector goes into alarm, unless the detector is set for alarm verification. • If the detector is set for alarm verification, the base activates when the detector goes into alarm verification. It does not restore, however, until the alarm restores. • The base does not respond when the detector goes into prealarm no matter how the detector is configured. • Devices with the base set to follow "Head" cannot be placed in correlation groups. When a device base is set to follow "Head," the base is removed as an output from any Correlation Groups to which it belongs.

Alarm: The base activates its relay when the detector goes into alarm. The base will not restore until the alarm event has been restored.

Alarm and verify (ALM+VFY): The base activates its relay when the detector goes into alarm verify and continues when the detector goes into alarm. The base will not restore until both events have been restored.

Alarm and prealarm (ALM+PALM): The base activates its relay when the detector goes into prealarm and continues when the detector goes into an alarm. The base will not restore until both events have been restored.

Riser: The base is triggered individually by the loop controller (sounder bases only)

None: A correlation group triggers the base. It can be applied to both relay and sounder bases and is used for relay bases configured as latched output devices.

Note: All base follow settings except "Head" and "Riser" can be activated by correlation groups.

Incremental programming procedure

Referring to Table 20 on page 64, follow these steps to auto program the panel. Not all options shown in Table 20 are displayed on all systems.

Notes

- Use the Right or Left Arrow button rather than the Enter button to select values for each option. The Enter button starts the incremental program sequence immediately no matter which option the cursor is on.
- The values you select are preserved and will be displayed as defaults the next time you incrementally program the panel.

To perform incremental programming:

1. Press the menu button and choose Program.
2. Choose Incremental Program.
3. Enter a level two password.
4. Set the incremental programming options using Table 20 on page 64.
5. When you have finished, press Enter.

The panel begins incremental programming and displays the number of devices on the system. If the panel has two loops, the device counts for each loop are given separately. The system displays the number of old and new devices.

6. Press Enter to continue.

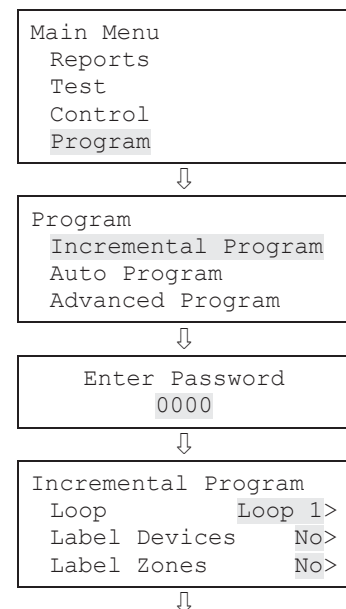

Incremental programming continues based on the settings you made above.

7. If you chose to label devices and/or zones, use the procedures that follow to enter labels.
8. When incremental programming is complete, the system returns you to the banner screen.

```

Auto Program
System Busy
#####
<Back          <Cancel
    
```



```

Devices      Old/New
Loop 1      XXX/YYY
Loop 2      XXX/YYY
<Continue
    
```

— Or —

```

Devices:      Old/New
              XXX/YYY
<Continue
    
```

Labeling devices

If you set the Label Devices incremental programming option to yes, follow this procedure to label the devices.

To label devices:

1. Next to “Device,” enter the number of the device to be labeled.
2. Enter a text label for the device (two lines of 20 characters). The default label is “Loop X Device XXX.”
3. Press Enter to save the label and go to the next number of the device.

```

Loop 1      Device 001
Label goes here
Label continued
<Save          <Back
    
```

Note: Pressing the Enter button saves the current label and displays the next device number. This lets you move quickly from one device to the next.

4. Repeat steps 2 and 3 until all devices are labeled.
5. When you have finished labeling, place the cursor on the device number, and press the Cancel button to continue with the next incremental programming option.

See “Programming relay and sounder detector bases” on page 95.

Labeling zones

If you set the Label Zones incremental programming option to Yes, follow these steps to label zones.

To label zones:

1. Enter the zone number to be labeled.
2. Enter a text label for the zone (two lines of 20 characters). The default label is "Zone XX."
3. Press Enter to save the label and go to the next zone number. Note: Pressing the Enter button saves the current label and then goes to the next zone number so that you can quickly go to each zone and label it.
4. Enter a text label for the zone (two lines of 20 characters).
5. Repeat steps 3 and 4 until all zones are labeled.
6. When you have finished labeling, move the cursor to the zone number, and press the Cancel button to continue with the next incremental programming option.

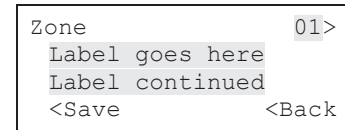

Adding and removing devices from programmed systems

You can add an additional device or several devices to a system that has already been programmed without re-entering programming mode. Once the device is installed, the panel signals a trouble active event and indicates on the LCD screen that there is an unconfigured device. The device can then be programmed and added to the database.

Notes

- If you are adding more than a few devices, you may want to use the Incremental programming option that lets you quickly add and label the devices. See "Performing incremental programming" on page 64.
- You must log on with a level two password to add a device.

Device programming options

Table 21 below describes the options to be set when programming devices.

Table 21: Device options

Device option	Description
Zone	Select the zone you want to add this device to or Select Off if you are not adding the device to a zone.
Label	Enter a text label for the device (two lines of 20 characters). When you have finished, select Save.
Correlation groups	<p>Assigns the device to one or more correlation groups. For more information, see “What is a correlation group?” on page 32.</p> <p>Enter the number of the correlation group to which the device is assigned. Choose Included or Excluded.</p> <ul style="list-style-type: none"> • “Included” adds assigns the item to the group. • “Excluded” removes the item from the group <p>When you have finished, choose Save.</p>
Event notification	<p>Sets the options needed for message for the active, trouble, disable, prealarm, alarm verify, maintenance alert, and test event. See “Factory default settings” on page 35 for device event notification default settings.</p> <p>Printer: Yes or No. This controls whether event information is sent to the printer</p> <p>Coder: four-digit coded output that is played in response to alarm conditions (00-00-00-00 to 99-99-99-99)</p> <p>Dialer:</p> <p>Acct 1 2: Event information is sent to both dialer accounts</p> <p>Acct 1: Event information is sent to dialer account one</p> <p>Acct 2: Event information is sent to dialer account two</p> <p>None: Event information is not sent to the dialer</p> <p>NET: Yes or No. Controls whether event information is sent to the connected Ethernet receiver</p> <p>CID: Contact ID event code (000 to 999)</p> <p>When you have finished, choose Save.</p>
Day sensitivity	Sets the daytime smoke level sensitivity. Choose least, less, more, normal, or most.
Night sensitivity	Sets the nighttime smoke level sensitivity. Choose least, less, more, normal, or most.
Day prealarm%	<p>Sets the daytime prealarm percentage. Choose Off or 50, 55, 60, 65, 70, 75, 80, or 90 percent.</p> <p>This sets the amount of smoke that indicates a prealarm event before an actual alarm event is indicated. The percentage is based on the sensitivity level selected above. For example, if you choose normal sensitivity and select 50 percent for your prealarm, when smoke levels reach 50% of the normal smoke level required to initiate an alarm, a prealarm event will be indicated.</p>

Device option	Description
Night prealarm%	<p>Sets the nighttime prealarm percentage. Choose Off or 50, 55, 60, 65, 70, 75, 80, or 90 percent.</p> <p>This sets the amount of smoke that indicates a prealarm event before an actual alarm event is indicated. The percentage is based on the sensitivity level selected above. For example, if you choose normal sensitivity and select 50 percent for your prealarm, when smoke levels reach 50% of the normal smoke level required to initiate an alarm, a prealarm event will be indicated.</p>
Base type	Sets the base type for detectors. Choose standard, relay, isolator, or sounder.
Follow	<p>This option controls the conditions that will activate the relay or sounder detector base. Select from the following values:</p> <p>Head: The base is controlled by the detector's settings:</p> <ul style="list-style-type: none"> • The base activates when the detector goes into alarm, unless the detector is set for alarm verification. • If the detector is set for alarm verification, the base activates when the detector goes into alarm verification. It does not restore, however, until the alarm restores. • The base does not respond when the detector goes into prealarm no matter how the detector is configured. • Devices with the base set to follow "Head" cannot be placed in correlation groups. When a device base is set to follow "Head," the base is removed as an output from any Correlation Groups to which it belongs. <p>Alarm: The base activates its relay when the detector goes into alarm. The base will not restore until the alarm event has been restored.</p> <p>Alarm and verify (ALM+VFY): The base activates its relay when the detector goes into alarm verify and continues when the detector goes into alarm. The base will not restore until both events have been restored.</p> <p>Alarm and prealarm (ALM+PALM): The base activates its relay when the detector goes into prealarm and continues when the detector goes into an alarm. The base will not restore until both events have been restored.</p> <p>Riser: The base is triggered individually by the loop controller (sounder bases only)</p> <p>None: A correlation group triggers the base. It can be applied to both relay and sounder bases and is used for relay bases configured as latched output devices.</p> <p>Note: All base follow settings except "Head" and "Riser" can be activated by correlation groups.</p>
Type	<p>Select the device type based on the type of device you are programming.</p> <p>Note: All possible device types are listed below. Available device types are determined by marketplace, however, so all device types listed here may not be listed for the device you are programming.</p>

Device option	Description
	<p>Photo detectors</p> <p>Smoke: For smoke detectors and contact devices. All activations are immediately considered as alarms. Circuit cannot be restored until devices are restored to normal and the panel is reset.</p> <p>Smoke verified: For smoke detectors and contact devices. Two-wire smoke detector activations are verified (delayed and confirmed) before activating an alarm. Four-wire smoke detectors and contact devices are not verified and immediately considered as alarms. Circuit cannot be restored until devices are restored to normal and the panel is reset.</p> <p>Supervisory latching: For detectors that trigger an active (supervisory) event. Detectors with this device type remain active until the condition that activated them is restored and the control panel is reset.</p> <p>Supervisory nonlatching: For detectors that trigger an active (supervisory) event. Detectors with this device type remain active until the condition that activated them is restored. Resetting the control panel is not required.</p>
	<p>Ion detectors</p> <p>Smoke: For smoke detectors and contact devices. All activations are immediately considered as alarms. Circuit cannot be restored until devices are restored to normal and the panel is reset.</p> <p>Smoke verified: For smoke detectors and contact devices. Two-wire smoke detector activations are verified (delayed and confirmed) before activating an alarm. Four-wire smoke detectors and contact devices are not verified and immediately considered as alarms. Circuit cannot be restored until devices are restored to normal and the panel is reset.</p> <p>Supervisory latching: For detectors that trigger an active (supervisory) event. Detectors with this device type remain active until the condition that activated them is restored and the control panel is reset.</p> <p>Supervisory nonlatching: For detectors that trigger an active (supervisory) event. Detectors with this device type remain active until the condition that activated them is restored. Resetting the control panel is not required.</p>
	<p>Duct detectors</p> <p>Duct alarm: For duct smoke detectors. All activations are immediately considered as alarms. Circuit cannot be restored until devices are restored to normal and the panel is reset.</p> <p>Duct supervisory (latching and nonlatching): For duct supervisory devices. Momentary activation of normally open devices immediately places the panel in a supervisory state and turns on supervisory LEDs and relays. Circuit cannot be restored until devices are restored to normal and the panel is reset.</p>

Device option	Description
	<p>Heat detectors</p> <p>Heat alarm: For heat detectors and contact devices. All activations are immediately considered as alarms. Circuit cannot be restored until devices are restored to normal and the panel is reset.</p> <p>Heat alarm RoR: For heat detectors and contact devices with rate-of-rise. All activations are immediately considered as alarms. Circuit cannot be restored until devices are restored to normal and the panel is reset.</p> <p>Input module device types</p> <p>2Wire Class A: Allows for the monitoring of two-wire conventional smoke detectors in a Class A circuit (that do not require alarm verification) and normally open contact initiating devices on the same circuit.</p> <p>2Wire Class B: Allows for the monitoring of two-wire conventional smoke detectors in a Class B circuit (that do not require alarm verification) and normally open contact initiating devices on the same circuit</p> <p>2Wire verify Class A: Allows for the monitoring of two-wire conventional smoke detectors in a Class A circuit (that require alarm verification)</p> <p>2Wire verify Class B: Allows for the monitoring of two-wire conventional smoke detectors in a Class B circuit (that require alarm verification)</p> <p>Alarm: For smoke detectors and contact devices. All activations are immediately considered as alarms. Circuit cannot be restored until devices are restored to normal and the panel is reset.</p> <p>Duct alarm: For duct smoke detectors. All activations are immediately considered as alarms. Circuit cannot be restored until devices are restored to normal and the panel is reset.</p> <p>Heat: For heat detectors and contact devices. All activations are immediately considered as alarms. Circuit cannot be restored until devices are restored to normal and the panel is reset.</p> <p>Pull station: For pull station devices. All activations are immediately considered as alarms.</p> <p>Remote drill: For a remote switch that when activated, starts the panel's drill operation.</p> <p>Remote reset: For a remote switch that when activated, resets the panel.</p> <p>Remote signal silence: For a remote switch that when activated, silences the signaling devices.</p> <p>Waterflow: For connecting vane type and pressure flow switches. Activations are considered as alarms. A 16-second alarm delay applies to waterflow activations. Circuit cannot be restored until devices are restored to normal and the panel is reset. Waterflow activations do not invoke in-suite signal silence.</p>

Device option	Description
Relay device types	
	Relay nonsilence NC: For relay devices that open when activated and remain open when you press Signal Silence.
	Relay nonsilence NC (latched): For latching relay devices that open when activated and remain open when you press Signal Silence.
	Relay nonsilence NO: For relay devices that close when activated and remain closed when you press Signal Silence.
	Relay nonsilence NO (latched): For latching relay devices that close when activated and remain closed when you press Signal Silence.
	Relay nonsilenceable: For relay devices that do not follow signal silence
	Relay nonsilenceable (latched): For relay devices that do not follow signal silence and do not restore until manually unlatched
	Relay silence: For relays that turn off when you press Signal Silence.
	Relay silence NC: For relays that open when activated and close when you press Signal Silence.
	Relay silence NO: For relays that close when activated and open when you press Signal Silence.
	Relay silenceable: For relay devices that follow signal silence.
	Relay silenceable: For relay devices that follow signal silence.
Supervisory device types	
	Duct supervisory (latching and nonlatching): For duct supervisory devices. Momentary activation of normally open devices immediately places the panel in a supervisory state and turns on supervisory LEDs and relays. Circuit cannot be restored until devices are restored to normal and the panel is reset.
	Supervisory latching: For supervisory devices. Momentary activation of normally open devices immediately places the panel in a supervisory state and turns on supervisory LEDs and relays. Circuit cannot be restored until devices are restored to normal and the panel is reset.
	Supervisory nonlatching: For supervisory devices. Momentary activation of normally open devices immediately places the panel in a supervisory state and turns on the supervisory LED and relay. Annunciation remains active until the input restores. The panel does not have to be reset.
Trouble device types	
	Remote AC fail: For use with auxiliary power supplies to provide AC Fail indication to the fire panel. The fire panel treats this activation as if the panel itself detected an AC fail condition. Delays off-premises signaling for the selected time duration.
Monitor device types	
	Monitor: Monitoring of normally open switches for other functions (fire door position, etc.). Not approved for use under ULC 527 in Canada.

Device option	Description
Output device types	
	Continuous nonsilenceable: For nonsilenceable strobes and notification appliances that self-generate a temporal pattern.
	Continuous nonsilenceable (latched): For latching strobes and notification appliances that self-generate a temporal pattern.
	Continuous silenceable: For strobes and notification appliances that self generate a noncoded tone.
	Duct alarm: For duct smoke detectors. All activations are immediately considered as alarms. Circuit cannot be restored until devices are restored to normal and the panel is reset.
	Duct supervisory (latching and nonlatching): For duct supervisory devices. Momentary activation of normally open devices immediately places the panel in a supervisory state and turns on supervisory LEDs and relays. Circuit cannot be restored until devices are restored to normal and the panel is reset.
	Genesis audible visible silence: For Genesis and Enhanced Integrity horns and strobes. Genesis and Enhanced Integrity appliances maintain synchronization per UL 1971. For Genesis devices only, connected horns can be silenced and strobes turn off.
	Genesis nonsilenceable: For Genesis and Enhanced Integrity horns and strobes. Genesis and Enhanced Integrity appliances maintain synchronization per UL 1971. For Genesis devices only, connected horns cannot be silenced and strobes on the same two-wire circuit flash until the panel is reset.
	Monitor: Monitor: Monitoring of normally open switches for other functions (fire door position, etc.). Not approved for use under ULC 527 in Canada.
	Relay nonsilence NC: For relay devices that open when activated and remain open when you press Signal Silence.
	Relay nonsilence NC (latched): For latching relay devices that open when activated and remain open when you press Signal Silence.
	Relay nonsilence NO: For relay devices that close when activated and remain closed when you press Signal Silence.
	Relay nonsilence NO (latched): For latching relay devices that close when activated and remain closed when you press Signal Silence.
	Relay nonsilenceable: For relay devices that do not follow signal silence
	Relay nonsilenceable (latched): For relay devices that do not follow signal silence and do not restore until manually unlatched.
	Relay silence: For relays that turn off when you press Signal Silence.
	Relay silence NC: For relays that open when activated and close when you press Signal Silence.
	Relay silence NO: For relays that close when activated and open when you press Signal Silence.
	Relay silenceable: For relay devices that follow signal silence.
	Relay silenceable: For relay devices that follow signal silence.

Device option	Description
	Supervised output: For modules that output an unsynchronized signal and that do not turn off when you press Signal Silence.
	Supervised output (latched): For latched output modules that output an unsynchronized signal and that do not turn off when you press Signal Silence.
	Unlatch outputs: For output modules that manually unlatch latched outputs.
	Latched output device types
	Supervised Outputs (Latched) : For Class B latched output modules that output an unsynchronized signal. Does not follow signal silence.
	Continuous Non-Silenceable (Latched) : For Class B latched output modules that output an unsynchronized signal. Does not follow signal silence.
	Continuous Non-Silenceable Class A (Latched) — Cont NS CIA Latch: For Class A latched output modules that output an unsynchronized signal. Does not follow Signal Silence.
	Supervised Outputs Class A (Latched): For Class A latched output modules that output an unsynchronized signal. Does not follow Signal Silence.
	Relay Non-Silenceable (Latched): For Class B relay devices functioning as latched output devices. Does not follow signal silence.
	Relay Non-Silence Normally Open (Latched): For relay devices functioning as latched output devices that close when activated. Does not follow signal silence.
	Relay Non-Silence Normally Closed (Latched): For relay devices functioning as latched output devices that open when activated. Does not follow signal silence.

1. Table 24 on page 96 gives a full list of devices configurable as latched output devices.
2. The following output modules can be configured to unlatch latched outputs: SIGA-CT1, SIGA-CT2, SIGA-MAB, SIGA-MCT2, SIGA-MM1, and SIGA-UM.

Adding devices

To add a device to a programmed system:

1. Install the device on the system.
 The system recognizes the new device and displays a trouble event message that indicates that there is an unprogrammed device.
2. Press Enter.
 The device details screen is displayed.
3. Press Enter again, and enter a level two password (if you are not already logged on).
 The Add Device screen is displayed.
4. Verify the device that you are about to add, and press Enter.
 The Device programming menu is displayed. If the device is not a valid device, "invalid device" is displayed and you will be unable to program the device.
5. Program device options using Table 19 on page 61.
 Some device options have a factory default setting that you can accept or change. See "Factory default settings" on page 35.

Notes

- If you added a dual address device, both addresses for the device are displayed on the screen (e.g. 001/002). The first address listed is the device address you are programming. When you pick the second address to program, both addresses are still displayed but in reverse order (e.g. 002/001).
 - Depending on the type of device you are programming, some of the options in the Table 19 on page 61 may not be available.
6. When you have finished programming each option, choose Save. The device is added to the database and the unprogrammed device event is cleared.
 7. Press the Menu button to exit menu mode.

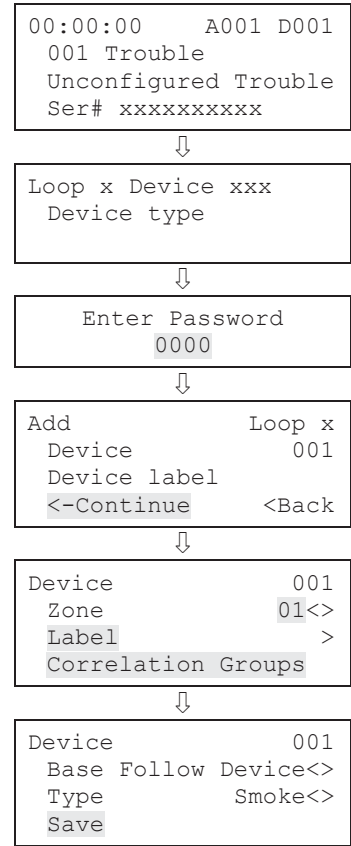

You can remove a device from the system and delete it from the database without going into programming mode.

Removing devices

To remove a device from a programmed system:

1. Physically remove the device from the system.
The system indicates a communication fault with a trouble event.
Note: If the system is configured as a zoned system, the panel displays two events, one for the zone and one for the device.
2. Press Enter.
The device details screen is displayed.
3. Press Enter.
The Enter Password screen is displayed if you are not logged on. If you are already logged on, the Delete Device screen is displayed; go to step 5.
4. Enter a level two password.
The Delete Device screen is displayed.
5. Verify the device you are about to delete by reviewing the information on the screen.
6. Press Enter to delete the device and save the change in the database.
7. Repeat these steps for each device you are removing from the system.

```
00:00:00    A001 D001
001 Trouble
Communication Fault
```



```
Loop x Device xxx
Device type
Comm Fault
Ser# xxxxxxxxxx
```



```
Enter Password
0000
```



```
Delete          Loop x
Device          001
Device label
<-Save        <Cancel
```

Advanced programming

Overview

Advanced programming lets you program the panel manually and apply custom settings. Most options have a factory default setting that you can accept or change. See “Factory default settings” on page 35.

In advanced programming, you can custom program the loop configuration options (loops, devices, zones, etc.), panel configuration options (annunciators, dialer, network, printer, etc.), panel operation options (language, marketplace, AC fail delay, etc.), panel events, and loop events. All of these options can be programmed directly from the front panel.

To do advanced programming, you must have a level two password and it is recommended that you complete the programming worksheets and have them available before beginning to program the system. Go to Appendix B “Worksheets” on page 195 to get a copy of each worksheet.

Note: Before starting the auto programming sequence, set the time and date and change the default passwords. See “Changing the passwords” on page 49 and “Setting the time and date” on page 46.

Panel and loop programming options

Advanced programming lets you customize panel operation, panel configuration, and loop configuration. Configuration options include:

- Annunciator class programming
- Annunciator programming
- CMS device programming
- Dialer programming
- NAC programming
- Network programming
- Network card programming
- Printer programming

Loop configuration options include:

- Correlation groups programming
- Device programming
- Loop 2 enable
- Loop class programming
- Zone programming

Panel operation options include:

- Language
- Marketplace
- AC fail delay
- Zone resound
- Reset inhibit
- Auto signal silence
- In-suite signal silence
- Day start
- Night start
- Daylight savings
- Date
- Aux power reset
- LCD banner
- Key #1
- Key #2

Advanced programming for panel and loop options is covered in the following topics in this chapter.

Programming events

Advanced programming lets you create custom responses to these types of events:

- Panel events
- Loop events

Advanced programming for panel and loop events is covered in the last two topics in this chapter.

Changing loop configuration options

Loop configuration options

Loop configuration includes the following programmable options:

Table 22: Loop configuration options

Option	Description
Loop class	Indicates whether the loop is wired Class A or Class B.
Zone	Select this option to add a zone.
Correlation Groups	Select this option to add correlation groups.
Device	Select this option to add devices.
Mapping	Select Yes to enable mapping. Select No to disable mapping.
Loop 2 Enable [1]	Select Yes to enable Loop 2. Select No to disable Loop 2. [1]
Loop 2 Fst Grp [1] [2]	Select: 001 to 025 to combine loop 1 and 2 devices in the same fast groups, or 101 to 125 to use separate fast groups for Loop 2 devices.

[1] Displayed in dual loop systems only.

[2] See “Programming fast groups for sounder bases” on page 85.

Most options have a factory default setting that you can accept or change.

See “Factory default settings” on page 35.

To change loop configuration options:

1. Press the menu button and choose Program.
2. Choose Advanced Program.
3. Enter a level two password.
4. Choose Loop Configuration.
5. Program the options.

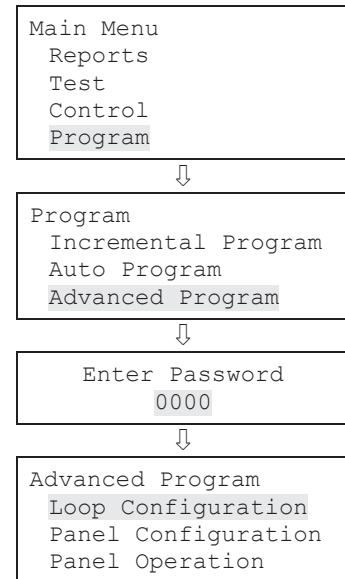

Correlation group programming

This section includes instructions for:

- Using fast groups
- Adding members to correlation groups
- Enabling in-suite signal silence
- Setting the activation count
- Copying members of a correlation group
- Removing all members from a correlation group

Note: To meet the UL\ULC requirement that evacuation signals activate within 10 seconds, assign sounder base detectors to “fast” correlation groups.

See “Programming fast groups for sounder bases” on page 85.

If you are new to correlation group programming, see “What is a zone?” on page 32.

Adding members to correlation groups

Correlation groups can include zones, NACs, devices, unconfigured alarm events, and the common trouble event. See the following procedure.

To add or remove members from a correlation group:

1. Press the Menu button and choose Programming.
2. Choose Advanced Program and enter the level 2 password.
3. Choose Correlation Groups and enter the correlation group number to be programmed. (Values range from 001 to 199.)
4. Choose:
 - Add/Remove Zone to add or remove a zone.
 - Add/Rem Panel NAC to add or remove a NAC.
 - Add/Remove Device to add or remove a device.
5. Enter the loop number (if the panel has multiple loops).
6. Enter the zone, NAC, or device number.
7. On the Status line, press Enter to select Included or Excluded:
 - “Included” adds the item to the group.
 - “Excluded” removes the item from the group
8. Repeat steps 4 to 7 to add or remove other devices, zones, or NACs.
9. Repeat steps 3 to 9 to program additional correlation groups.
10. Press the Menu button to exit menu mode, or continue programming.

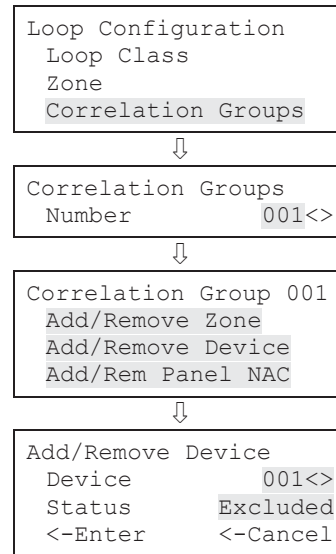

To add the Common Trouble Event to a correlation group:

1. Press the Menu button and choose Programming.
2. Choose Advanced Program and enter the level 2 password.
3. Choose Common Trouble then choose Trouble.
4. Choose Correlation Groups and enter the number of the correlation group to be configured.
5. Press Enter to toggle between possible values:
 - “Included” adds the item to the group.
 - “Excluded” removes the item from the group
6. Repeat steps 7 to 9 to add or remove the event from any remaining correlation groups to be configured.
7. Choose Save.
8. Press the menu button to exit menu mode or continue programming.

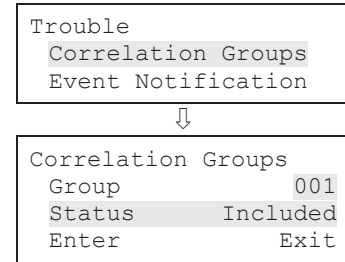
**Setting a correlation group's activation count**

A correlation group's activation count is the number of member activations that are required to activate the correlation group. The activation count is used to set up cross zoning. The following rules apply:

- The count cannot exceed the number of input members in the correlation group.
- The default value is 1.
- Input members can be zones, NACs, devices, unconfigured alarm events, or the common trouble event.
- The activation count must be 1 for correlation groups with in-suite signal silence enabled.

To set the activation count:

1. Press the Menu button and choose Programming.
2. Choose Advanced Program and enter the level 2 password.
3. Choose Loop Configuration.
4. Choose Correlation Groups and enter the number of the correlation group to be programmed. (Values range from 001 to 199.)
5. Choose Activation Count and enter the activation count (values range from 01 to 99).
6. Choose Save.

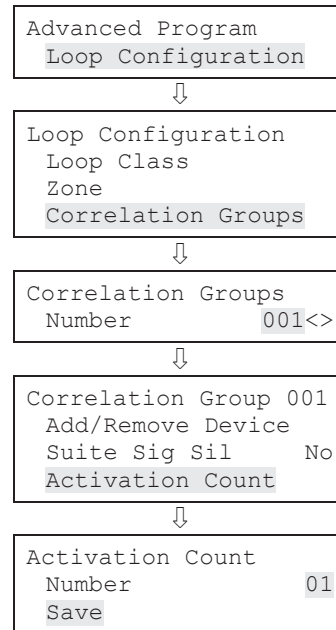

To copy the members of a correlation group:

1. Press the Menu button and choose Programming.
2. Choose Advanced Program and enter the level 2 password.
3. Choose Loop Configuration.
4. Choose Correlation Groups.
5. Enter the number of the correlation group to be programmed. (Values range from 001 to 199.)
6. Choose Copy and enter the number of the correlation group to be copied.
7. Choose Save.

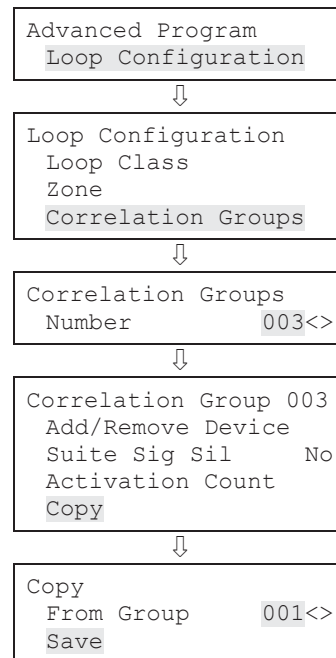

To remove all members from a correlation group:

1. Press the Menu button and choose Programming.
2. Choose Advanced Program and enter the level 2 password.
3. Choose Loop Configuration.
4. Choose Correlation Groups.
5. Enter the number of the correlation group. (Values range from 001 to 199.)
6. Choose Remove All. A warning message is displayed.
7. Choose Continue to remove all members from the group.

— or —

Press the Cancel button to return to the previous level without removing all members.

Note: Removing all members from a correlation group resets the activation count to 1 and disables in-suite signal silence.

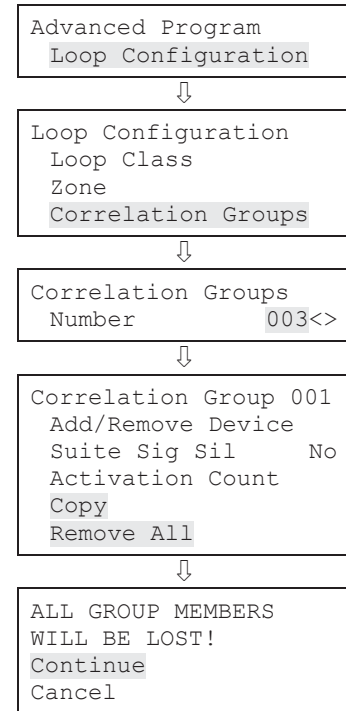
**Programming in-suite signal silence**

In-suite signal silence is programmed using two separate menus:

- Configure the elapse timer for in-suite signal silence by displaying the Program > Advanced Program > Panel Operation menu.
- The functionality is enabled for individual correlation groups through the Program > Advanced Program > Loop Configuration > Correlation Groups menu.

This section provides instructions for setting both in-suite signal silence options.

Note: When Setting up correlation groups for in-suite signal silence, the group's activation count must be set to 1. See "Setting a correlation group's activation count" on page 81.

To enable in-suite signal silence for a correlation group:

1. Press the Menu button and choose Programming.
2. Choose Advanced Program and enter the level 2 password.
3. Choose Loop Configuration.
4. Choose Correlation Groups and enter the number of the correlation group. (Values range from 001 to 199.)
5. Choose Suite Sig Sil.
6. Select:
 Yes to enable in-suite signal silence.
 No to disable it.
7. Choose Save.

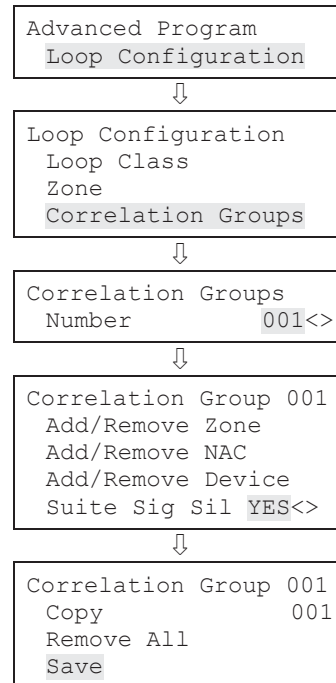

To set the in-suite signal silence elapse timer:

1. Press the Menu button and choose Programming.
2. Choose Panel Operation and enter the level 2 password.
3. For the Suite Sig Sil option, enter a value from 1 to 10 minutes (The default is 10). To disable in-suite signal silence, set this option to Off.

This is a global option that sets the shutdown period during which “in suite” evacuation signals outside the alarm zone remain silenced.

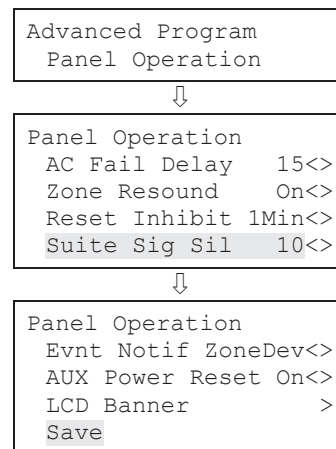

Programming fast groups for sounder bases

UL/ULC require alarms to sound within 10 seconds after a fire is detected. This can be difficult to achieve in large systems with hundreds of sounders, unless the sounders are properly grouped.

To address this requirement, Vigilant VS1 and VS2 systems provide 25 high priority correlation groups per loop that can activate all sounders simultaneously. These are:

- For panels with one loop only, the fast correlation groups are Groups 001 to 025
- For panels with two loops, the fast correlation groups are

Loop 1: groups 001 to 025

Loop 2: groups 001 to 025 or 101 to 125 (user configurable).

In dual loop systems, you can combine devices from loop 1 and 2 in correlation groups 001 to 025, or you can separate them and use groups 101 to 125 for loop 2. See “Changing loop configuration options” on page 78.

For best performance use the fast correlation groups for bulk activations, such as entire floors and save the slower correlation groups for small sets of activations such as individual suites or hotel rooms.

Note: Be sure the Follow option for devices to be added is None, Alarm, Alarm and Verify, or Alarm and Prealarm. Be sure the Follow option is *not* set to Head or Riser. If you need to run a report to check the Follow option, see “Device Details report” on page 175. If you need to change the Follow option, see “Adding and removing devices from programmed systems” on page 67.

To add sounder base detectors to a fast group:

1. Press the Menu button and choose Programming.
2. Choose Advanced Program and enter the level 2 password.
3. Choose Correlation Groups and enter the correlation group number to be programmed. Enter a value from:
 - For panels with one loop only, the fast correlation groups are Groups 001 to 025
 - For panels with two loops, the fast correlation groups are
 - Loop 1: groups 001 to 025
 - Loop 2: groups 001 to 025 or 101 to 125 (user configurable).

See “Programming fast groups for sounder bases” on page 85.
4. Choose Add/Remove Device.
5. Enter the loop number (if the panel has multiple loops).
6. Enter the device number.
7. Add the detector as an input and the sounder base as an output. Choose:
 - Sensor to add the detector
 - or —
 - Base to add the sounder base
8. On the Status line, press Enter to select Included. This adds the device to the group.
9. Repeat steps 4 to 8 to add or remove other devices, zones, or NACs.
10. Repeat steps 3 to 9 to program additional correlation groups.
11. Press the Menu button to exit menu mode, or continue programming.

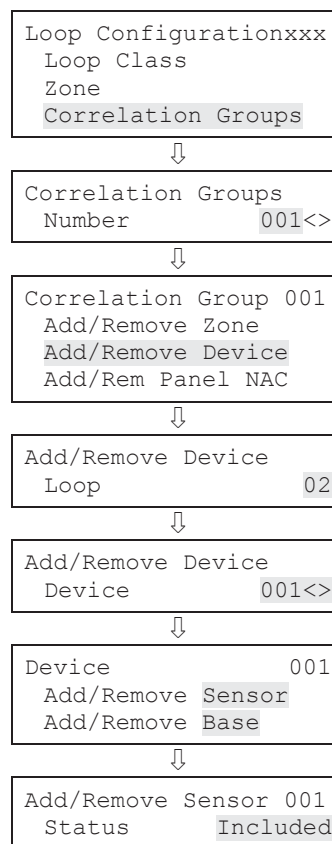

Device programming

Each device that operates on a notification appliance circuit (NAC) or device loop has operating parameters that must be set. This includes assigning a device type and label, programming event notification, etc.

Note: Devices are programmed by entering the address of the device to be programmed, then setting the device options. It is important to have a printout of the Device Details > Serial Number report to correlate the device address with the default label and serial number. This will make device programming much easier. See “Device Details report” on page 175.

Table 23: Programming Devices – Device options

Option	Description
Zone	<p>Identifies the zone to which the device will be added.</p> <p>To add the device to a zone, enter the zone number.</p> <p>— or —</p> <p>If the device will not be added to a zone, select Off.</p> <p>Note: Do not mix device and zone types. For example, do not place a nonlatching supervisory device in an alarm zone. When the supervisory device activates and an alarm event is initiated, the alarm event automatically clears when the device restores without having to reset the panel.</p>
Label	<p>Contains the two lines of text displayed beneath the device number on the LCD.</p> <ol style="list-style-type: none"> 1. Enter text for the device label (two lines of 20 characters). 2. When you have finished, choose Save.
Correlation groups	<p>Lets you add the device to (or remove it from) one or more correlation groups.</p> <ol style="list-style-type: none"> 1. Enter the number of the first correlation group to be configured. 2. To add the device to the correlation group, select Included. <p>— or —</p> <ol style="list-style-type: none"> 3. To remove the device from the correlation group, select Excluded. 4. Repeat steps 1 to 3 for any other correlation groups to be configured. 5. When you have finished, choose Save. <p>For more information, see “What is a correlation group?” on page 32.</p>
Event notification	<p>Sets notification options (printer, coder, dialer, and contact ID) for active, trouble, disable, prealarm, alarm verify, maintenance alert, and test events)</p> <p>See “Factory default settings” on page 35 for device event notification defaults.</p> <ol style="list-style-type: none"> 1. Select an event type and set its notification options. 2. Repeat until all event types have been set. 3. When you have finished, choose Save.

Option	Description
	<p>Printer: Yes or No. This controls whether event information is sent to the printer</p> <p>Coder: four-digit coded output that is played in response to alarm conditions (00-00-00-00 to 99-99-99-99)</p> <p>Dialer:</p> <p>Acct 1 2: Event information is sent to both dialer accounts</p> <p>Acct 1: Event information is sent to dialer account one</p> <p>Acct 2: Event information is sent to dialer account two</p> <p>None: Event information is not sent to the dialer</p> <p>NET: Yes or No. Controls whether event information is sent to the connected network</p> <p>CID: Contact ID event code (000 to 999)</p>
Day sensitivity	Set the daytime smoke level sensitivity to least, less, more, normal, or most.
Night sensitivity	Set the nighttime smoke level sensitivity to least, less, more, normal, or most.
Day prealarm%	Set the daytime prealarm percentage to Off or 50, 55, 60, 65, 70, 75, 80, or 90 percent. This is the amount of smoke that indicates a prealarm event before an actual alarm event is indicated. The percentage is based on the sensitivity level selected above. For example, if you select normal sensitivity and select 50 percent for prealarm, when smoke levels reach 50% of the normal smoke level required to initiate an alarm, a prealarm event will be indicated.
Night prealarm%	Set the nighttime prealarm percentage to Off or 50, 55, 60, 65, 70, 75, 80, or 90 percent. This is the amount of smoke that indicates a prealarm event before an actual alarm event is indicated. The percentage is based on the sensitivity level selected above. For example, if you select normal sensitivity and select 50 percent for prealarm, when smoke levels reach 50% of the normal smoke level required to initiate an alarm, a prealarm event will be indicated.
Base type	Set to the type of base (standard, relay, isolator, or sounder) being used with the detector.
Follow	<p>This option controls the conditions that will activate the relay or sounder detector base. Select from the following values:</p> <p>Head: The base is controlled by the detector's settings:</p> <ul style="list-style-type: none"> • The base activates when the detector goes into alarm, unless the detector is set for alarm verification. • If the detector is set for alarm verification, the base activates when the detector goes into alarm verification. It does not restore, however, until the alarm restores. • The base does not respond when the detector goes into prealarm no matter how the detector is configured. <p>Riser: The base is triggered individually by the panel (sounder bases only)</p> <p>None: A correlation group triggers the base. "None" can be applied to both relay and sounder bases, and is used for relay bases configured as latched output devices.</p>

Option	Description
	<p>Note: All base follow settings except “Head” and “Riser” can be activated by correlation groups.</p> <p>Alarm: The base activates its relay when the detector goes into alarm. The base will not restore until the alarm event has been restored.</p> <p>Alarm and verify (ALM+VFY): The base activates its relay when the detector goes into alarm verify and continues when the detector goes into alarm. The base will not restore until both events have been restored.</p> <p>Alarm and prealarm (ALM+PALM): The base activates its relay when the detector goes into prealarm and continues when the detector goes into an alarm. The base will not restore until both events have been restored.</p>
Type	<p>Select the device type based on the type of device you are programming.</p> <p>Note: Available device types depend on the device and the marketplace selected for the panel. Some device types are not available in some marketplaces. For this reason, the LCD listing for the selected device may differ from this table.</p> <p>Note: To correlate device types with personality codes when programming Signature Series devices, see Appendix E “Device types to personality codes correlation” on page 257.</p> <p>Photo detector</p> <p>Smoke: For smoke detectors and contact devices. All activations are immediately considered as alarms. Circuit cannot be restored until devices are restored to normal and the panel is reset.</p> <p>Smoke verified: For smoke detectors and contact devices. Two-wire smoke detector activations are verified (delayed and confirmed) before activating an alarm. Four-wire smoke detectors and contact devices are not verified and immediately considered as alarms. Circuit cannot be restored until devices are restored to normal and the panel is reset.</p> <p>Supervisory latching: For supervisory devices. Momentary activation of normally open devices immediately places the panel in a supervisory state and turns on supervisory LEDs and relays. Circuit cannot be restored until devices are restored to normal and the panel is reset.</p> <p>Supervisory nonlatching: For supervisory devices. Momentary activation of normally open devices immediately places the panel in a supervisory state and turns on the supervisory LED and relay. Annunciation remains active until the input restores. The panel does not have to be reset.</p> <p>Ion detector</p> <p>Smoke: For smoke detectors and contact devices. All activations are immediately considered as alarms. Circuit cannot be restored until devices are restored to normal and the panel is reset.</p> <p>Smoke verified: For smoke detectors and contact devices. Two-wire smoke detector activations are verified (delayed and confirmed) before activating an alarm. Four-wire smoke detectors and contact devices are not verified and immediately considered as alarms. Circuit cannot be restored until devices are restored to normal and the panel is reset.</p> <p>Supervisory latching: For supervisory devices. Momentary activation of</p>

Option	Description
	<p>normally open devices immediately places the panel in a supervisory state and turns on supervisory LEDs and relays. Circuit cannot be restored until devices are restored to normal and the panel is reset.</p> <p>Supervisory nonlatching: For supervisory devices. Momentary activation of normally open devices immediately places the panel in a supervisory state and turns on the supervisory LED and relay. Annunciation remains active until the input restores. The panel does not have to be reset.</p>
	<p>Duct detector</p> <p>Duct alarm: For duct smoke detectors. All activations are immediately considered as alarms. Circuit cannot be restored until devices are restored to normal and the panel is reset.</p> <p>Duct supervisory (latching and nonlatching): For duct supervisory devices. Momentary activation of normally open devices immediately places the panel in a supervisory state and turns on supervisory LEDs and relays. Circuit cannot be restored until devices are restored to normal and the panel is reset.</p>
	<p>Heat detector</p> <p>Heat: For heat detectors and contact devices. All activations are immediately considered as alarms. Circuit cannot be restored until devices are restored to normal and the panel is reset.</p> <p>Heat alarm RoR: For heat detectors and contact devices with rate-of-rise. All activations are immediately considered as alarms. Circuit cannot be restored until devices are restored to normal and the panel is reset.</p>
	<p>Input modules</p> <p>Alarm: For smoke detectors and contact devices. All activations are immediately considered as alarms. Circuit cannot be restored until devices are restored to normal and the panel is reset.</p> <p>Alarm Class A: For modules wired to Class A circuits composed of pull stations, four-wire smoke detectors, or other dry contact alarm initiating devices. Modules with this device type trigger active (alarm) events.</p> <p>Audible: For NACs connected to audible notification appliances that turn off when Signal Silence is pressed</p> <p>Continuous Nonsilenceable: For modules wired to a Class B circuits that output an unsynchronized signal that does not turn off when you press Signal Silence.</p> <p>Continuous Nonsilenceable (Latched): For latched output modules wired to a Class B circuits that output an unsynchronized signal that does not turn off when you press Signal Silence.</p> <p>Continuous Non-Silenceable Class A: For modules wired to Class A circuits that output an unsynchronized signal that does not turn off when you press Signal Silence.</p> <p>Continuous Non-Silenceable Class A (Latched): For latched output modules wired to a Class A circuits that output an unsynchronized signal that does not turn off when you press Signal Silence.</p>

Option	Description
	Continuous Silenceable: For modules wired to a Class B circuits that output an unsynchronized signal that turns off when you press Signal Silence.
	Continuous Silenceable Class A: For modules wired to Class A circuits and you want the module to output an unsynchronized signal that turns off when you press Signal Silence.
	Duct alarm: For duct smoke detectors. All activations are immediately considered as alarms. Circuit cannot be restored until devices are restored to normal and the panel is reset.
	Duct supervisory (latching and nonlatching): For duct supervisory devices. Momentary activation of normally open devices immediately places the panel in a supervisory state and turns on supervisory LEDs and relays. Circuit cannot be restored until devices are restored to normal and the panel is reset.
	Genesis audible visible silence: For Genesis and Enhanced Integrity horns and strobes. Genesis and Enhanced Integrity appliances maintain synchronization per UL 1971. For Genesis devices only, connected horns can be silenced and strobes turn off.
	Genesis nonsilenceable: For Genesis and Enhanced Integrity horns and strobes. Genesis and Enhanced Integrity appliances maintain synchronization per UL 1971. For Genesis devices only, connected horns cannot be silenced and strobes on the same two-wire circuit flash until the panel is reset.
	Heat: For heat detectors and contact devices. All activations are immediately considered as alarms. Circuit cannot be restored until devices are restored to normal and the panel is reset.
	Heat Class A: For modules wired to Class A circuits composed only of heat detectors. Modules with this device type trigger active (alarm) events.
	Monitor: Monitoring of normally open switches for other functions (fire door position, etc.). Not approved for use under ULC 527 in Canada.
	Monitor Class A: For modules wired to Class A circuits composed only of switches used to monitor the operation of external equipment. Modules with this device type trigger active (monitor) events.
	Pull station: For pull station devices. All activations are immediately considered as alarms.
	Pull Station Class A: For modules wired to Class A circuits composed only of pull stations. Modules with this device type trigger active (alarm) events.
	Remote AC fail: For use with auxiliary power supplies to provide AC Fail indication to the fire panel. The fire panel treats this activation as if the panel itself detected an AC fail condition. Delays off-premises signaling for the selected time duration.
	Remote AC Fail Class A: For modules wired to Class A circuits composed of a relay that only closes when a remote auxiliary/booster supply loses AC power.
	Remote drill: For a remote switch used to start the panels drill operation.
	Remote reset: For a remote switch that when activated, resets the panel.
	Remote signal silence: For a remote switch that when activated, silences the

Option	Description
	NACs connected to the panel.
	Smoke: For modules wired to a Class B circuit composed only of four-wire smoke detectors. Modules with this device type trigger active (alarm) events.
	Smoke Class A: For modules wired to Class A circuits composed only of four-wire smoke detectors. Modules with this device type trigger active (alarm) events.
	Supervised Output: For modules wired to Class B circuits that output an unsynchronized signal that does not turn off when you press Signal Silence.
	Supervised output Class A: For modules wired to Class A circuits that output an unsynchronized signal that does not turn off when you press Signal Silence.
	Supervised output Class A (latched): For latched output modules wired to Class A circuits that output an unsynchronized signal that does not turn off when you press Signal Silence.
	Supervised output (latched): For latched output modules wired to Class B circuits that output an unsynchronized signal that does not turn off when you press Signal Silence.
	Supervised output Class A: For modules wired to Class A circuits that output an unsynchronized signal that does not turn off when you press Signal Silence.
	Supervisory latching: For supervisory devices. Momentary activation of normally open devices immediately places the panel in a supervisory state and turns on supervisory LEDs and relays. Circuit cannot be restored until devices are restored to normal and the panel is reset.
	Supervisory Latching Class A: For modules wired to Class A circuits composed only of supervisory switches. Modules with this device type trigger active (supervisory) events. The module remains active until the condition that activated it is restored and the control panel is reset.
	Supervisory nonlatching: For supervisory devices. Momentary activation of normally open devices immediately places the panel in a supervisory state and turns on the supervisory LED and relay. Annunciation remains active until the input restores. The panel does not have to be reset.
	Supervisory Non-latching Class A: For modules wired to Class A circuits composed only of supervisory switches. Modules with this device type trigger active (supervisory) events. The module remains active until the condition that activated it is restored. Resetting the control panel is not required.
	Unlatch outputs: For Class A or B Signature input module circuits used to unlatch all latched outputs. The following output modules can be configured to unlatch latched outputs: SIGA-CT1, SIGA-CT2, SIGA-MAB, SIGA-MCT2, SIGA-MM1, and SIGA-UM.
	Visible: For NACs connected to visible notification appliance that do not turn off when Signal Silence is pressed.
	Waterflow: For connecting vane type and pressure flow switches. Activations are considered as alarms. A 16-second delay applies to waterflow device types. NACs activated by waterflow device types cannot be silenced until the activated devices are restored to normal via a panel reset. Circuit cannot be restored until devices are restored to normal and the panel is reset. Waterflow

Option	Description
	<p>activations do not invoke in-suite signal silence.</p> <p>Water Flow Class A: For modules wired to Class A circuits composed only of waterflow alarm switches. Modules with this device type initiate active (alarm) events if the circuit remains shorted for at least 16 seconds. NACs activated by waterflow device types cannot be silenced until the activated devices are restored to normal via a panel reset. Circuit cannot be restored until devices are restored to normal and the panel is reset. Waterflow activations do not invoke in-suite signal silence.</p>
	<p>Relay module</p> <p>Relay nonsilence: For relay devices that do not follow signal silence.</p> <p>Relay with silence: For relay devices that follow signal silence.</p>
	<p>Latched outputs</p> <p>Supervised Outputs (Latched) — SupOut Latch: For Class B latched output modules that output an unsynchronized signal. Does not follow signal silence.</p> <p>Continuous Non-Silenceable (Latched) Cont NS Latch: For Class B latched output modules that output an unsynchronized signal. Does not follow signal silence.</p> <p>Continuous Non-Silenceable ClsA (Latched) — Cont NS CIA Latch: For Class A latched output modules that output an unsynchronized signal. Does not follow Signal Silence.</p> <p>Supervised Outputs ClsA (Latched) — SupOut CIA Latch: For Class A latched output modules that output an unsynchronized signal. Does not follow Signal Silence.</p> <p>Relay Non-Silenceable (Latched) — Relay Latch: For Class B relay devices functioning as latched output devices. Does not follow signal silence.</p> <p>Relay Non-Silence NO (Latched) — Relay NO Latch: For relay devices functioning as latched output devices that close when activated. Does not follow signal silence.</p> <p>Relay Non-Silence NC (Latched) — Relay NC Latch: For relay devices functioning as latched outputs that open when activated. Does not follow signal silence.</p>

To program an input or output device:

1. Press the Menu button and choose Programming.
2. Choose Advanced Program and enter the level 2 password.
3. Choose Device.
4. If the panel has multiple loops, choose the loop to be configured.
5. Enter the device address to be configured.
For the Vigilant VS2 panel, addresses 1 to 125 are detectors and addresses 126 to 250 are modules.

Note: The device label occupies two lines just below the device label.

6. Program each device in the system using Table 23 on page 87.

Note: If you chose a dual address device, both addresses for the device are displayed on the screen (e.g. 001/002). The first address listed is the device address you are programming. When you pick the second address to program, both addresses are still displayed but the order is reversed (e.g. 002/001).

Note: Depending on the type of device you are programming, some of the options in the table below may not be available.

7. When you finish programming an option, choose Save, then choose the next option.
8. Press the Menu button to exit menu mode, or continue programming.

```
Loop Configuration
Loop class
Zone
Correlation Groups
Device
```



```
Device
Loop 01<>
```



```
Device
Number 001
Device label line 1
Device label line 2
```



```
Device 001
Zone 01<>
Label <>
Event notification
Correlation Groups
Day Sens Normal<>
Night Sens Normal<>
Day PreAlarm% 50<>
Night PreAlarm%
50<>
Base Type Sounder<>
Follow Alarm<>
Type Smoke<>
Save
```



```
Device 001
Base Follow
Device<>
Type Smoke<>
Save
```

Programming relay and sounder detector bases

Relay and sounder bases require some configuration not required by other devices. First, the panel does not automatically distinguish between relay and sounder bases — Both are set by default to base type “relay”. You must manually change this setting for sounder bases.

In addition, configuration is required to control how these devices are activated. Relay bases can be activated by:

- The detector to which they are attached
- One or more correlation groups

Sounder bases can be activated by:

- The detector to which they are attached
- One or more correlation groups
- The 24 volt riser

You can configure these options using the procedure given below. See Table 23 on page 87 for information on the Base and Follow options.

To change the relay/sounder base type and follow option:

1. Press the Menu button and choose Programming.
2. Choose Advanced Program and enter the level 2 password.
3. Choose Loop Configuration and select the loop number. (This option is displayed only if the panel has two loops.)
4. Choose Devices and enter the number of the device to be programmed. The serial number of the device is displayed.
5. Press the Enter button.
6. Choose Base Type and select either Relay or Sounder.
7. Choose Follow and select one of the types listed in Table 23 on page 87.
8. Choose Save.
9. Press the Menu button to exit menu mode, or continue programming.

Programming relay modules and bases as latched output devices

Latched outputs are relays that are configured to shut down air handlers and dampers during an alarm. Table 24 below lists relay modules and relay bases that can be configured as latched outputs. The following table lists the device types used to configure a device as a latched output.

The latched outputs must be manually unlatched and then restored. The unlatch command affects all latched outputs system-wide. You can assign the Unlatch Outputs command to a programmable key on the front panel or to a Class A or B Signature input module circuit with one of the devices listed in Table 24 below. The following output modules can be configured to unlatch latched outputs: SIGA-CT1, SIGA-CT2, SIGA-MAB, SIGA-MCT2, SIGA-MM1, and SIGA-UM.

For information on assigning the unlatch command to a programmable key, see “Setting up the programmable keys” on page 51.

Table 24: Output modules configurable as latched outputs

Output modules		
SIGA CC1	SIGA CRR	SIGA MCC2
SIGA CC1S	SIGA IO	SIGA MCC1S
SIGA CC2	SIGA MAB	SIGA MCRR
SIGA CR	SIGA MCC1	SIGA MIO
SIGA CR2	SIGA MCR	SIGA UM
Relay bases		
SIGA-RB [1]		
SIGA-RB4 [1]		

[1] Relay bases support any of the following detectors: HFS, HRS, IPHS, IS, PHS, and SD. To configure the base as a latched output, configure the attached detector’s base type to “Relay” and set the Latched option to “Yes.”

Table 25: Device types for latched outputs

Type	Description
Supervised Outputs (Latched)	SupOut Latch. For Class B latched output modules that output an unsynchronized signal. Does not follow signal silence.
Continuous Non-Silenceable (Latched)	Cont NS Latch. For Class B latched output modules that output an unsynchronized signal. Does not follow signal silence.

Type	Description
Continuous Non-Silenceable ClsA (Latched)	Cont NS CIA Latch. For Class A latched output modules that output an unsynchronized signal. Does not follow signal silence.
Supervised Outputs ClsA (Latched)	SupOut CIA Latch. For Class A latched output modules that output an unsynchronized signal. Does not follow signal silence.
Relay Non-Silenceable (Latched)	Relay Latch. For Class B relay devices functioning as latched outputs. Does not follow signal silence.
Relay Non-Silence NO (Latched)	Relay NO Latch. For relay devices functioning as latched outputs that close when activated. Does not follow signal silence.
Relay Non-Silence NC (Latched)	Relay NC Latch. For relay devices functioning as latched outputs that open when activated. Does not follow signal silence.

To configure a relay module or base as a latched output:

1. Press the Menu button and choose Programming.
2. Choose Advanced Program and enter the level 2 password.
3. Choose Loop Configuration.
4. Choose Device.
5. If the panel has multiple loops, choose the loop to be configured.
6. Enter the device address to be configured. Device details are displayed.
7. Set the Base Type option to Relay.
8. Set the Follow option to None.
9. Set the Latched option to Yes.
10. Choose Type and select one of the Latched Outputs types listed in Table 24 on page 96 on page 96.
11. Press the Menu button to exit menu mode, or continue programming.

```

Loop configuration
Zone
Correlation groups
Device <>
    
```



```

Device
Number          001
Serial #        5199776279
    
```



```

Device          005/001
Base Type       Relay
Follow          None
Latched         Yes
    
```

Loop 2 enable

If your system is using two device loops (the optional loop expander card is installed), you must enable the second loop so that it can be programmed.

To enable loop 2:

1. Press the Menu button and choose Programming.
2. Choose Advanced Program and enter the level 2 password.
3. Choose Loop 2 Enable.
4. Select:
Yes to enable the loop
No to disable the loop
5. Choose Save.
6. Press the Menu button to exit menu mode, or continue programming.

```
Loop Configuration
Mapping
Loop 2 Enable  Yes>
Save
```



```
Loop Configuration
Mapping
Loop 2 Enable  Yes>
Save
```

Selecting loop classes

The loop class must be programmed Class A or Class B based on how the devices are wired on the loop). The default setting is Class B.

To select a loop class:

1. Press the Menu button and choose Programming.
2. Choose Advanced Program and enter the level 2 password.
3. Choose Loop Class.
4. Select the loop. If you only have one loop, the loop is automatically selected.
5. Select either Class A or Class B.
6. Choose Save.
7. Press the Menu button to exit menu mode, or continue programming.

```
Loop Configuration
Loop Class
Zone
Correlation Groups
```



```
Loop Class
Loop 1      Class A>
Loop 2      Class A>
Save
```



```
Loop Class
Loop 1      Class A>
Loop 2      Class A>
Save
```

Mapping loop device circuits

To use mapping, you must enable it for each loop on the system. Mapping a device data circuit provides useful information about the circuit that can be used for troubleshooting or documenting the electrical positions of devices on the system. Mapping the system provides a way for you to get an overall picture of the devices on the system.

When the system begins mapping the devices on the panel, “mapping in progress” is displayed on the LCD, the monitor LED flashes, and the panel buzzer sounds.

Depending on the number of devices on the panel, the amount of time it takes to map can vary.

Enabling and disabling mapping

When you enable mapping, you allow the panel to automatically identify all devices installed on the loop.

To enable or disable mapping:

1. Press the Menu button and choose Programming.
2. Choose Advanced Program and enter the level 2 password.
3. Choose Loop configuration
4. Choose Mapping.
5. If the panel has multiple loops, select the loop to be configured.
6. Select Yes to enable mapping or No to disable mapping.
7. Choose Save.
8. Press the Menu button to exit menu mode, or continue programming.

```
Loop Configuration
Correlation Groups
Device
Mapping
```



```
Mapping
Loop 1      Yes<>
Loop 2      Yes<>
Save
```

— or —

```
Mapping
Enable      Yes<>
Save
```



```
Mapping
Loop 1      Yes<>
Loop 2      Yes<>
Save
```

— or —

```
Mapping
Enable      Yes<>
Save
```

Correcting a map mismatch

You can work with maps using the front panel or by using the configuration utility. Accepting a map refers to saving the map in the control panel’s database either from the front panel or through the configuration utility.

When mapping is enabled, the control panel stores two maps in memory, a map in RAM and a map in the database. When these two maps do not match, a map mismatch is generated at the front panel.

There are several reasons why the maps may not match. For example, if you just enabled mapping, the panel maps the devices on the system and stores the map in panel RAM, but because there is no map in the panel database, you get a map mismatch.

Saving the map in the panel database synchronizes the two maps and removes the map fault from the system.

Another way to get a map mismatch is by adding a new device to the system. The panel sees the device and generates a new map in RAM. This map is not the same as the map in the panel database, so a map mismatch is generated. From the map mismatch screen, you can save the map in the panel database, which synchronizes the two maps and removes the map mismatch from the system.

To accept a map using front panel controls:

1. On the loop map mismatch event screen, press Enter.

The details screen is displayed.

```
00:00:00   A001 D001
001 Trouble
Loop 1 Map Mismatch
```

2. Press Enter.

The Enter Password screen is displayed if you are not logged on. If you are already logged on, the Accept Map screen is displayed.

↓

```
Loop x Device xxx
```

3. Enter a level two password.

The Accept Map screen is displayed.

↓

```
Enter Password
0000
```

4. Press Enter to save the map in the control panel database.

Saving the map clears the mismatch.

↓

```
Accept Map

<-Save <Cancel
```

If mapping is enabled, you may have a discrepancy between the map that was downloaded to the panel from the configuration utility and the map that resides in the control panel RAM. If the two maps do not match, the system generates a map mismatch event. If you get a map mismatch, you have to either accept the control panel map and save it in the control panel database or adjust the database (and download it again) so that it matches the control panel map.

For example, if you add a new device in the configuration utility, but the device has not been physically wired into the system, when you download to the panel from the configuration utility, the configuration utility map will not match the panel map, generating a map mismatch. You can then either leave the map mismatch on the system until you install the new device, at which time the panel detects the device

and clears the map mismatch or, you can accept the panel map as it is, which will not include the new device. When you install the new device, the panel will map the device and generate a map mismatch. You can redownload to the panel when this occurs. The configuration utility map and panel map will then match and the map mismatch event will clear.

Note: For details about using the configuration utility, refer to the online help system.

Using the configuration utility to map the system

If mapping is enabled, you may have a discrepancy between the map that was downloaded to the panel from the configuration utility and the map that resides in the control panel RAM. If the two maps do not match, the system generates a map mismatch event. If you get a map mismatch, you have to either accept the control panel map and save it in the control panel database or adjust the database (and download it again) so that it matches the control panel map.

For example, if you add a new device in the configuration utility, but the device has not been physically wired into the system, when you download to the panel from the configuration utility, the configuration utility map will not match the panel map, generating a map mismatch. You can then either leave the map mismatch on the system until you install the new device, at which time the panel detects the device and clears the map mismatch or, you can accept the panel map as it is, which will not include the new device. When you install the new device, the panel will map the device and generate a map mismatch. You can redownload to the panel when this occurs. The configuration utility map and panel map will then match and the map mismatch event will clear.

Note: For details about using the configuration utility, refer to the online help system.

Zone programming

Notes

- For background information about zones, see “What is a zone?” on page 32.
- If the system does not have zones, no programming is required in this section. If the panel is not configured for zone or zone/device reporting, programming here has no affect on the system except for CMS reporting.

Table 26: Zone programming options

Type	Set zone type to: Alarm: For circuits with smoke detectors and contact devices. All activations are immediately considered as alarms. Circuit cannot be restored until devices are restored to normal and panel is reset. Monitor: Monitoring of normally open switches for other functions
------	---

	<p>(fire door position, etc.). Not approved for use under ULC 527 in Canada.</p> <p>Supervisory: For supervisory devices. Momentary activation of normally open devices immediately places the panel in a supervisory state and turns on the supervisory LED and relay.</p> <p>The device types of devices in supervisory zones control whether it is latching or nonlatching. If all devices in the zone are latching devices, or if you mix latching and nonlatching devices, the zone will operate as latching.</p> <p>Waterflow: Activates alarm events when a waterflow switch closes. Select this zone type when the devices in the zone are only connected to waterflow switches.</p> <p>Note: Do not mix device and zone types. For example, do not place a nonlatching supervisory device in an alarm zone. When the supervisory device activates and an alarm event is initiated, the alarm event automatically clears when the device restores without having to reset the panel.</p>
Label	Enter a text label for the zone (two lines of 20 characters). When you have finished, choose Save.
Correlation groups	<p>Enter the number of the correlation group. Choose Yes or No.</p> <ul style="list-style-type: none"> • “Yes” adds the item to the group. • “No” removes the item from the group <p>When you have finished, choose Save. For more information on correlation groups, see “What is a correlation group?” on page 32.</p>
Event notification	<p>Set the active, trouble, disable, prealarm, alarm verify, maintenance alert, and test event information by choosing one and then setting the notification information. When you have finished, choose Save. See “Factory default settings” on page 35 for zone event notification default settings.</p> <p>Note: If your CMS is set to zone reporting, the event notification information sent to the receiver comes from the programming in this section.</p> <p>Printer: Yes or No. This controls whether event information is sent to the printer</p> <p>Dialer:</p> <ul style="list-style-type: none"> Acct 1 2: Event information is sent to both dialer accounts Acct 1: Event information is sent to dialer account one Acct 2: Event information is sent to dialer account two None: Event information is not sent to the dialer <p>NET: Yes or No. Controls whether event information is sent to the connected network</p> <p>CID: Contact ID event code (000 to 999)</p>

To program a zone:

1. Press the Menu button and choose Programming.
2. Choose Advanced Program and enter the level 2 password.
3. Choose Loop Configuration.
4. Choose Zone and enter the zone number.
5. Program each zone in the system using Table 26 on page 101.
6. When you finish programming an option, choose Save, and then continue.
7. Press the Menu button to exit menu mode, or continue programming.

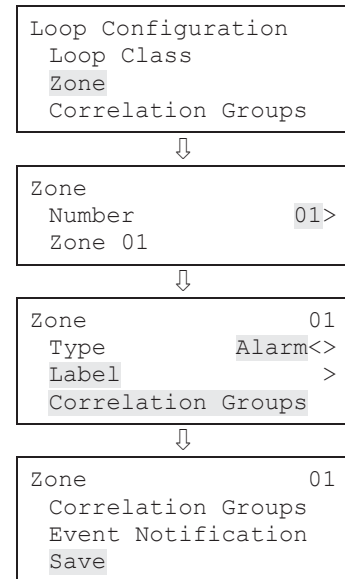
**Panel programming**

The panel options to be configured include:

- NAC circuits ("NACs")
- Annunciator class
- Annunciator
- Dialer and network ("CMS device")
- Printer
- IP address ("IP")
- Subnet mask ("MSK")
- Gateway ("GWY")

Most options have a factory default setting that you can accept or change. See "Factory default settings" on page 35.

Notes

- The option "CMS device" is only available if a dialer or network card is installed
- The option "Printer" is only available if a printer (RS-232) card is installed
- The options "IP", "MSK", and "GWY" are only available if a network card is installed

To display panel configuration options:

1. Press the Menu button and choose Programming.
2. Choose Advanced Program and enter the level 2 password.
3. Choose Panel Configuration.
4. Program the options.

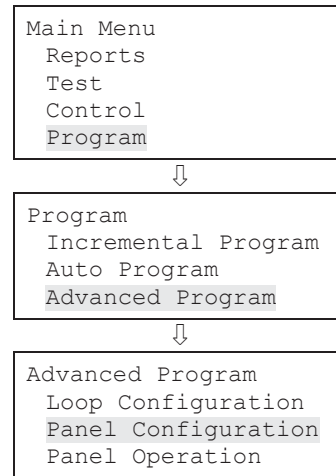

NAC programming

The NAC circuits connected to the system must be programmed with the type of NAC, label, correlation groups, and event notification. Each NAC must be programmed separately.

Table 27: NAC programming options

Option	Description
Class	Select either Class A or Class B. Note: NAC 3 and 4 cannot be set to Class A. If NAC 1 and 2 are set to Class A, NAC 3 and 4 automatically configure to accept the Class A return.
Type	Set NAC type to: Continuous (silenceable or nonsilenceable): For strobes and notification appliances that self-generate a temporal pattern Temporal (silenceable or nonsilenceable): Universal 3-3-3 pattern required for evacuation signals by NFPA 72. Used when notification appliances are not capable of self-generating a temporal pattern. Genesis (nonsilenceable or with audible silence or with audible/visible silence): For Genesis and Enhanced Integrity horns and strobes. Genesis and Enhanced Integrity appliances maintain synchronization per UL 1971. Nonsilenceable: Horns cannot be silenced and strobes flash Audible silence: Horns can be silenced while strobes continue to flash Audible/visible silence: For Genesis devices only, connected horns can be silenced and strobes turn off Coder (basic, continuous, 120 SPM, or temporal): Used to provide four-digit coded output in response to alarm conditions. When the

Option	Description
	<p>device goes into alarm, the coded output is played a minimum of four times by the NAC circuit. The code comes from the active initiating device or zone. Note: The panel can only play one code at a time. For example, device 1 is coded as 1-2-3-4 and is associated with NAC1 and device 2 is coded as 5-6-7-8 and is associated with NAC2. If device 1 activates, NAC1 plays 1-2-3-4. If, while NAC1 is playing 1-2-3-4, device 2 activates, NAC2 will also play 1-2-3-4 until the rounds are complete and then both NACs will play 5-6-7-8 until those rounds are complete. If you are programming NACs as coded, remember that only one code can play at a time.</p> <p>Basic: Four rounds of the four-digit coded output are played</p> <p>Continuous: Four rounds of the four-digit coded output are played and then continuous is played</p> <p>120 SPM: Four rounds of the four-digit coded output are played and then 120 times per minute is played</p> <p>Temporal: Four rounds of the four-digit coded output are played and then a temporal pattern is played</p> <p>Continuous Non-Silenceable (Latched): For programming NAC as latched output</p> <p>City tie: Outputs an unsynchronized, 24-volt continuous (steady) signal that cannot be silenced. Select this NAC type when the NAC is connected to a city tie module.</p>
Label	<p>Enter a text label for the NAC (two lines of 20 characters). When you have finished, choose Save.</p>
Correlation groups	<p>Enter the number of the correlation group. Choose Yes or No.</p> <ul style="list-style-type: none"> • “Yes” adds the item to the group. • “Excluded” removes the item from the group <p>When you have finished, choose Save.</p> <p>Note: A correlation group is a collection of NACs and/or output devices (strobe) that responds to an input device (smoke detector). When you program the loop devices, you will have to correlate/assign the desired input device or zone to the correlation group that you want to activate. For more information on correlation groups, see “What is a correlation group?” on page 32.</p>
Event notification	<p>Set the trouble, disable, and test event information by choosing one and then setting the notification information. When you have finished, choose Save. “Factory default settings” on page 35 for NAC event notification default settings.</p> <p>Printer: Yes or No. This controls whether event information is sent to the printer</p> <p>Coder: four-digit coded output that is played in response to alarm conditions (00-00-00-00 to 99-99-99-99)</p> <p>Dialer:</p>

Option	Description
	Acct 1 2: Event information is sent to both dialer accounts
	Acct 1: Event information is sent to dialer account one
	Acct 2: Event information is sent to dialer account two
	None: Event information is not sent to the dialer
	NET: Yes or No. Controls whether event information is sent to the connected network
	CID: Contact ID event code (000 to 999)

To program a NAC:

1. Display the panel configuration options menu. See “Panel programming” on page 103.
2. Choose Panel NAC.
3. Enter the NAC (number) you want to program.
Note: NAC 3 and 4 are not available if either NAC 1 or 2 or both are set to Class A.
4. Program each NAC in the system using Table 27 on page 104.
5. When you finish programming each option, choose Save.
6. Press the Menu button to exit menu mode, or continue programming.

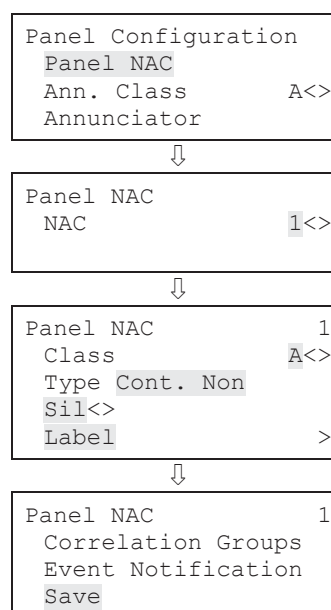

Setting annunciator classes

The annunciators connected to the system must have their wiring class (Class A or Class B) programmed.

Default: Class B

To set the annunciator class:

1. Display the panel configuration options menu. See “Panel programming” on page 103.
2. Choose Ann. Class.
3. Select either Class A or Class B.
4. Program other panel configuration options or choose Save if you’re finished.

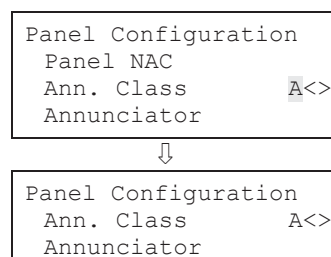

5. Press the Menu button to exit menu mode, or continue programming.

Save

Annunciator programming

Each annunciator on the annunciator loop must be programmed for type, number of expanders, label, and event notification. Up to eight annunciators can be connected on the loop and each must be programmed separately.

Table 28: Annunciator options

Option	Description
Annunciator type	<p>Set annunciator type to:</p> <p>Off: No annunciator is connected. Note: If type is set to Off, Number expanders, Label, and Reporting configuration are not available.</p> <p>LCD-C: The annunciator has a display and common controls</p> <p>LCD: The annunciator has a display only (no common controls)</p> <p>LED: The annunciator has LEDs and common controls (no display)</p> <p>Graphic: Graphics controller interface for the Envoy graphics board</p>
Expanders	<p>Set expanders to None, 1, or 2. This is the number of LED expander modules you are using with the annunciator.</p>
Label	<p>Enter a text label for the annunciator (two lines of 20 characters). When you have finished, choose Save.</p>
Event notification	<p>Set the trouble event information by setting the notification information. When you have finished, choose Save. See "Factory default settings" on page 35 for annunciator event notification default settings.</p> <p>Printer: Yes or No. This controls whether event information is sent to the printer</p> <p>Coder: four-digit coded output that is played in response to alarm conditions (00-00-00-00 to 99-99-99-99)</p> <p>Dialer:</p> <ul style="list-style-type: none"> Acct 1 2: Event information is sent to both dialer accounts Acct 1: Event information is sent to dialer account one Acct 2: Event information is sent to dialer account two None: Event information is not sent to the dialer <p>NET: Yes or No. Controls whether event information is sent to the connected network</p> <p>CID: Contact ID event code (000 to 999)</p>

To program an annunciator:

1. Press the Menu button and choose Programming.
2. Choose Advanced Program and enter the level 2 password.
3. Choose Panel Configuration.
4. Choose Annunciator.
5. Choose the annunciator you want to program.
6. Program each annunciator in the system using Table 28 on page 107.
7. When you finish programming each option, choose Save.
8. Press the Menu button to exit menu mode, or continue programming.

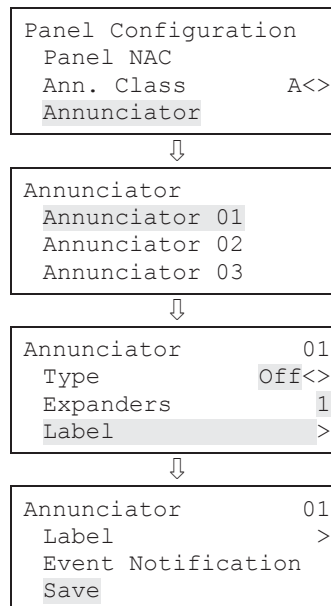

Central monitoring station device programming

CMS device programming

CMS devices are the devices that transmit system events to a central monitoring station’s receiver. This includes the dialer and the network.

Table 29: CMS device options

Option	Description
Dialer	See “Dialer programming” on page 110.
Network	See “CMS network (receiver) programming” on page 112.
Swinger shutdown	<p>Set swinger shutdown to Off or 1 to 255 repetitions. When you have finished, press Enter to save.</p> <p>Note: Off is the only acceptable setting for UL/ULC installations. See “UL 864 programming requirements” on page 31 for details.</p> <p>This automatically inhibits the number of consecutive times a single trouble event is transmitted over a 24-hour period before it is no longer sent. Some trouble events are not affected when swinger shutdown is set. They are:</p>

Option	Description
	<ul style="list-style-type: none"> - Loop 1 initializing - Loop 1 uncfgrd alarm - Loop 1 map mismatch - Loop 1 over limits - Loop 1 device 000 - Loop 1 mapping - Loop 1 map fault - Loop 2 initializing - Loop 2 map mismatch - Loop 2 over limits - Loop 2 device 000 - Loop 2 mapping - Loop 2 map fault - System startup - Reset - Reset/Sil inhibit - Panel silence - Program mode - Signal silence - Date
	<ul style="list-style-type: none"> - Drill - Walk test - Test fire - Time - Clear history - Common alarm - Common disable - Common monitor - Common supervisory - Common trouble - Battery charger - Battery low - Battery missing - Local AC power - System-wide AC power - Self test fault - Dialer dsbl/rem disc - Dialer normal test - Dialer abnormal test - Dialer configuration
Event notification	<p>Note: Programming event notification here is only required if you selected "Event" as your dialer account or network event notification setting. See "Dialer programming" on page 110 or "CMS network (receiver) programming" on page 112.</p> <p>Set the alarm, supervisory, monitor, trouble, disable, prealarm, alarm verify, maintenance alert, and test event information by choosing one and then setting the notification information. When you have finished, choose Save. See "Factory default settings" on page 35 for CMS device event notification default settings.</p> <p>Dialer:</p> <ul style="list-style-type: none"> Acct 1 2: Event information is sent to both dialer accounts Acct 1: Event information is sent to dialer account one Acct 2: Event information is sent to dialer account two None: Event information is not sent to the dialer <p>NET: Yes or No. Controls whether event information is sent to the connected network</p> <p>CID: Contact ID event code (000 to 999)</p>

To program CMS devices:

1. Display the panel configuration options menu. See “Panel programming” on page 103.
2. Choose CMS Device.
3. Choose the device you want to program.
4. Program each device and option using Table 29 on page 108. For dialer options, see Table 30 below. For receiver options, see Table 31 on page 113.
5. After programming each device option, choose Save.
6. Press the Menu button to exit menu mode, or continue programming.

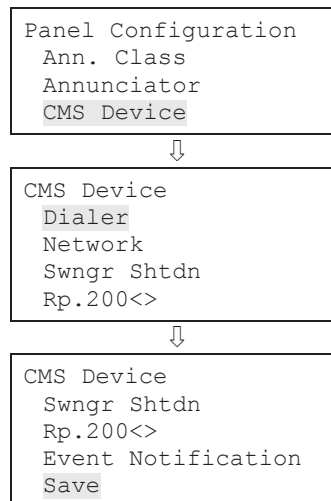

Dialer programming

The dialer has a number of options that can be programmed. The dialer can be used as a dialer for sending event information to the central monitoring station, and it can be used as a modem for dial-in programming and status and report retrieval.

Table 30: Dialer programming options

Option	Description
Type	<p>Set the dialer type to:</p> <p>Dual line: Uses LINE 1 and LINE 2 to transmit events to the central station receiver and performs modem functions.</p> <p>Single line: Uses LINE 1 only to transmit events to the central station receiver and performs modem functions.</p> <p>Modem only: Dialer provides interface for outbound communications and the ability for dial-in programming and status and report retrieval. Note: If Modem Only is selected, only Rings to Answer, Ring Type, and Callback Number can be programmed. No other dialer options are displayed in the menu. The modem function only works with LINE 1.</p> <p>None: No dialer is installed or if a dialer is installed, disables the dialer.</p>
Account 1 and 2	<p>Program account 1 options, and then program account 2 options. When you have finished programming each account, choose Save.</p> <p>Account ID: Enter account 1 and 2’s four-digit ID code. FFFF is not valid.</p> <p>Primary receiver number: Enter the primary receiver’s phone number. This can contain up to 20 digits (0-9, *, #, and ,). The comma causes a two-second delay in dialing. The number or hash symbol (#) and the asterisk symbol (*) are used with calling feature codes and services. Consult your telephone service provider.</p>

Option	Description
Secondary receiver number:	Enter the secondary receiver's phone number. This can contain up to 20 digits (0-9, *, #, and ,). The comma causes a two-second delay in dialing. The number or hash symbol (#) and the asterisk symbol (*) are used with calling feature codes and services. Consult your telephone service provider.
Format:	CID: Contact ID is the alarm format that the monitoring facility (DACR) will receive. See "Default contact ID event codes" on page 39.
Send restorals:	Set send restorals to: Yes: Sends off-normal event restorals to the monitoring facility (DACR). Required setting for UL/ULC installations. See "UL 864 programming requirements" on page 31 for details. No: Does not send off-normal event restorals to the monitoring facility (DACR)
Retry time seconds:	Set retry time to 1 to 45 seconds. Specifies the wait time between each time the dialer attempts a connection to the DACR.
Retry count:	Set the retry count to 5 to 10 attempts. Specifies how many times the dialer will attempt to call the DACR before timing out.
Event notification:	Set event notification (event reporting) to: Device: Only device information is reported or transmitted, no zone information. Note: This setting uses device event notification settings for reporting events. Make sure your device event notification settings are correct. See "Central monitoring station device programming" on page 108. Zone: When a device is a member of a zone, only the zone information is reported or transmitted. Device information is not reported or transmitted. Note: This setting uses zone event notification settings for reporting events. Make sure the zone event notification settings are correct. See "Loop event programming" on page 122. Event: Only the event type (alarm, supervisory, trouble, etc.) is reported or transmitted, no device or zone information. Note: This setting uses the CMS event notification settings for reporting events. Make sure the event notification settings are correct. See "Central monitoring station device programming" on page 108.
Line 1 and 2	Program line 1 options, and then program line 2 options. When you have finished programming each line, choose Save.
Dialing:	Select Tone or Pulse dialing.
Cut duration/supervision:	Set the cut duration/supervision to Off or 10 to 120 seconds. Specifies the length of time a phone line trouble is detected before reporting the trouble.
Tone wait seconds	Set tone wait to Off or 1 to 30 seconds. Specifies how long the dialer waits to get a dial tone.

Option	Description
Call disconnect seconds	Set call disconnect to Off or 1 to 45 seconds. Specifies the length of time the dialer seizes the line (to disconnect parallel devices) before attempting to dial out.
Test frequency days	Set test frequency to Off or 1 to 45 days. Specifies how often the dialer performs a test call. Note: The "off" setting is not acceptable for UL/ULC installations. See "UL 864 programming requirements" on page 31 for details.
Test time	Set the test time to the desired time of day for running the test.
Rings to answer	Set rings to answer to Off or 1 to 15 rings. Specifies how many rings before the dialer answers incoming calls.
Ring type	Set ring type to Any or Normal. Specifies the type of ring expected when an incoming call is received.
Callback	Select Enabled or Disabled.
Callback number	Enter the callback phone number (up to 20 digits). This specifies the phone number that is used for call back.

To program the dialer:

1. Display the panel configuration options menu. See "Panel programming" on page 103.
2. Choose CMS Device.
3. Choose Dialer.
4. Program the dialer using Table 30 on page 110. For dialer default settings, see "Factory default settings" on page 35.
5. When you have finished programming each option, choose Save.
6. Press the Menu button to exit menu mode, or continue programming.

```
Panel Configuration
Ann. Class
Annunciator
CMS Device
```



```
CMS Device
Dialer
Network
SwngR Shtdn
Rp.200<>
```



```
Dialer
Type      Single Line>
Account 1
Account 2
```



```
CMS Device
SwngR Shtdn
Rp.200<>
Event Notification
Save
```

CMS network (receiver) programming

The information being programmed here pertains to the central monitoring station (CMS) network that the control panel uses to communicate with the CMS. This is a TCP/IP Ethernet network. Event information is sent to the central monitoring station

just as it is when using a dialer, but the transmission is over an Ethernet network rather than the phone lines.

You must obtain the following information from the central monitoring station's network administrator:

- An IP address
- Port number
- Receiver number
- Line number

Note: CID is the only format that can be transmitted to the CMS over an Ethernet network.

Table 31: CMS network (receiver) programming options

Option	Description
Enabled	Yes: Enables the CMS network operation No: Disables the CMS network operation
Account ID	Enter the CMS account's four-digit ID code (0000 to FFFF). FFFF is not valid and must be changed.
IP	Enter the IP address for the CMS.
TCP/IP port	Enter the port address for the CMS (0 to 65535).
Send restorals	Set send restorals to: Yes: Sends off-normal event restorals to the monitoring facility (DACR) No: Does not send off-normal event restorals to the monitoring facility (DACR)
Event notification	Set event notification (event reporting) to: Device: Only device information is reported or transmitted, no zone information. Note: This setting uses device event notification settings for reporting events. Make sure the device event notification settings are correct. See "Central monitoring station device programming" on page 108. Zone: When a device is a member of a zone, only the zone information is reported or transmitted, no device information. Note: This setting uses zone event notification settings for reporting events. Make sure the zone event notification settings are correct. See "Central monitoring station device programming" on page 108. Event: Only the event type (alarm, supervisory, trouble, etc.) is reported or transmitted, no device or zone information. Note: This setting uses the CMS event notification settings for reporting events. Make sure the event notification settings are correct. See "Central monitoring station device programming" on page 108.

Option	Description
Hello time	Specifies the amount of time in between “hello” messages sent by the panel to the CMS to maintain communications. The time must be less than the hello timeout set on the CMS, otherwise the CMS will lose communication with the panel. Set hello time to 10 to 255 seconds.
Timeout seconds	Specifies the amount of time after a message is sent that the system waits for an acknowledgement before declaring a communication trouble. Values range from 31 to 255 seconds.
Receiver number	Specifies the CMS receiver number that receives system event messages. This number is part of the receiver message. Enter the CMS receiver number (0 to 9999) assigned to this panel by the CMS administrator.
Line number	Specifies the receiver’s line number where system event messages are sent. Enter the CMS receiver line number (0 to 9999) assigned to this panel by the CMS administrator.

To program the CMS network (receiver):

1. Display the panel configuration options menu. See “Panel programming” on page 103.
2. Choose CMS Device.
3. Choose Network.
4. Program the network using the Table 31 on page 113. For network default settings, see “Factory default settings” on page 35.
5. When you have finished programming each option, choose Save.
6. Press the Menu button to exit menu mode, or continue programming.

```
Panel Configuration
Ann. Class
Annunciator
CMS Device
```



```
CMS Device
Dialer
Network
SwngR Shtdn Rp.
200>
```



```
Network
Account ID      6769
IP      000.000.000.000
TCP/IP Port    00000
```



```
Network
Receiver#      0000
Line#          0000
Save
```

Printer programming

If a printer is connected to the system, you must set the printer type and configure printer event notification options. This controls where printer trouble events are sent and displayed.

To program a printer:

1. Display the panel configuration options menu. See “Panel programming” on page 103.
2. Choose Printer.
3. Choose Type.
4. Select the printer type.
 - Supervised: The printer connection is supervised (refer to the printer’s switch settings)
 - Unsupervised: The printer connection is not supervised
 - None/CU: There is no printer or you are connecting a computer running the configuration utility to the panel
5. Choose Event Notification.
6. Set printer trouble event notification. See “Factory default settings” on page 35 for printer event notification default settings.

Printer: Yes or No. This controls whether event information is sent to the printer

Dialer:

Acct 1 2: Event information is sent to both dialer accounts

Acct 1: Event information is sent to dialer account one

Acct 2: Event information is sent to dialer account two

None: Event information is not sent to the dialer

NET: Yes or No. Controls whether event information is sent to the connected network

CID: Contact ID event code (000 to 999)

7. When you have finished, choose Save.
8. Choose Save (on the Printer menu).
9. Press the Menu button to exit menu mode, or continue programming.

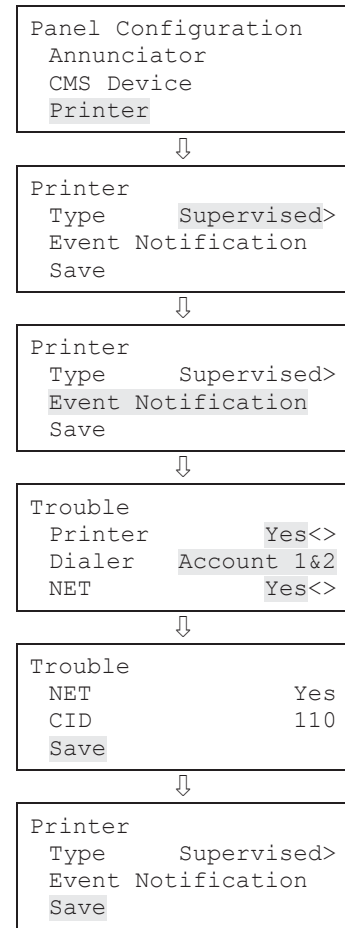

Ethernet card programming

If you are using the optional Ethernet network card, you must configure the IP address, subnet mask, and gateway so that it can communicate on the network. Contact your network administrator to obtain this information or use the default settings. The network card can be used to send event information to a central monitoring station, download to the panel from the configuration utility, or upload and view system reports using the configuration utility.

Network card default settings:

IP: 192.168.001.003

Mask: 255.255.255.000

Gateway: 000.000.000.000

To program network receivers:

1. Display the panel configuration options menu. See “Panel programming” on page 103.
2. Choose IP.
3. Enter the network card’s IP address.
4. Choose MSK.
5. Enter the network card’s subnet mask number.
6. Choose GWY.
7. Enter the network card’s gateway number.
8. Choose Save.
9. Press the Menu button to exit menu mode, or continue programming.

Panel	Configuration
IP	192.168.001.003
MSK	255.255.255.000
GWY	000.000.000.000

Panel	Configuration
MSK	255.255.255.000
GWY	000.000.000.000
	Save

Setting the Lock Remote Read function

Lock remote read controls incoming TCP/IP communications when a network card is installed and it is connected to a LAN or WAN. It restricts Telnet, ping, and CU read requests at the panel so that unwanted access to the panel is restricted, almost like a firewall.

Note: Lock remote read is active when no one is logged onto the panel or if someone with a level one password is logged on. When you log onto the panel with a level two password, all communication options are available and there are no restrictions.

To set the Panel Configuration lock remote read option:

1. Display the panel configuration options menu. See “Panel programming” on page 103.
2. Choose Lock Rmt Read.
3. Select either:
 Yes: Telnet, ping, and CU read access to the panel are restricted.
 No: Telnet is restricted, but ping and CU read access to the panel are allowed.
4. Program other panel configuration options or choose Save if you’re finished.
5. Press the Menu button to exit menu mode, or continue programming.

```
Panel Configuration
MSK 255.255.255.000
GWY 000.000.000.000
Lock Rmt Read Yes<>
```

```
Panel Configuration
GWY 000.000.000.000
Lock Rmt Read Yes<>
Save
```

AC voltage programming

AC Voltage is used to select the rated voltage of the mains supply connected to the control panel. The possible values are 110, 115, 120, 220, 230, and 240 VAC.

Note: Use 110, 115, and 120 only on 120 VAC control panel models. Use 220, 230, and 240 only on 230 VAC control panel models.

To set the AC voltage:

1. Display the panel configuration options menu. See “Panel programming” on page 103.
2. Choose AC Voltage.
3. Select 110, 115, 120, 220, 230, or 240.
4. Program other panel configuration options or choose Save if you’re finished.
5. Press the Menu button to exit menu mode, or continue programming.

```
Panel Configuration
GWY 000.000.000.000
Lock Rmt Read Yes<>
AC Voltage 120<>
```

```
Panel Configuration
Lock Rmt Read Yes<>
AC Voltage 120<>
Save
```

Panel operation programming

The panel operation options control how the panel operates. Most options have a factory default setting that you can accept or change. See “Factory default settings” on page 35.

Table 32: Panel operation options

Option	Description
Language	Select the desired display language: English or French
Marketplace	Select the desired marketplace: U.S. or Canada
AC fail delay	Set the AC fail delay time to: Off: Off-premises notification of an AC power failure is immediate. Note: The "off" setting is not acceptable for UL/ULC installations. See "UL 864 programming requirements" on page 31 for details. 1 to 15 hours: Delays the off-premises notification of an AC power failure by the time period selected
Zone resound	Set zone resound to: On: NACs resound each time a device in the zone goes into alarm even if they were silenced Off: Inhibits the NACs from turning on again (after they were silenced) when a second device in the zone goes into alarm. Note: The "off" setting is not acceptable for UL/ULC installations. See "UL 864 programming requirements" for details.
Reset inhibit	Set the time to: Off: Panel reset is operational immediately after NACs turn on 1 minute: Panel reset is operational one minute after NACs turn on
Auto signal silence	Set auto signal silence to: Off: Does not allow the panel to automatically silence the signals 5 to 30 minutes: Allows the panel to automatically silence the signals after the selected time period expires
Suite signal silence	Set the timer duration. The range of possible values is 1 to 10 minutes. The default value is 10 minutes.
Day start	Set the start time for daytime sensitivity
Night start	Set the start time for nighttime sensitivity
Date	Set the date format to: U.S.: MM/DD/YYYY Canada: DD/MM/YYYY
LCD banner	Enter the desired banner text for line one and line two using the keypad. Each line is capable of up to 20 characters. When you have finished, choose Save.
Aux power reset	On: "Reset" temporarily turns off the resettable aux power output Off: "Reset" does not turn off the resettable aux power output

Option	Description
Event notification	<p>Set event notification to:</p> <p>Zone: When a device is a member of a zone, only the zone information is sent to the LCD, LEDs, printer, and dialer. Note: Device level reporting configuration is not available.</p> <p>Zone/device: Zone information is sent to the LCD and LEDs. Device information is sent to the printer and dialer. Note: Zone/device reporting locations can be configured through custom programming.</p> <p>Device: Only device information is reported, no zone information.</p> <p>LED annunciator operation note: If you are using the optional LED expanders, the zone LEDs are assigned to device addresses 1 to 32 on loop 1. For example, zone 1 LEDs (red and yellow) are assigned to device 1 on loop 1.</p> <p>Remote annunciator operation note: If you are using the optional remote annunciators, when an event takes place on loop 1, the loop displays on the annunciator LCD as loop 17 (not loop 1). The device number of the device reporting the event is the correct device number. So, if an event takes place on loop 1, the remote annunciators will display it as loop 17. Loop 2 events will display on the annunciator LCD as loop 2 events.</p>
Key #1 and Key #2	See "Setting up the programmable keys" on page 51.

To program Panel Operation options:

1. Press the menu button and choose Program.
2. Choose Advanced Program.
3. Enter a level two password.
4. Choose Panel Operation.
5. Program the options using Table 32 on page 118.
Not all options shown in the table will be displayed on all systems.
6. When you finish programming each option, choose Save.
7. Press the Menu button to exit menu mode, or continue programming.

```
Main Menu
Reports
Test
Control
Program
```



```
Program
Incremental Program
Auto Program
Advanced Program
```



```
Enter Password
0000
```

```
Advanced Program
Loop Configuration
Panel Configuration
Panel Operation
```



```
Panel Operation
Language English>
Marketplace US>
AC Fail Delay 15>
```

Event programming

Panel event programming

Panel events, such as reset, system startup, and battery low have an event notification setting for contact ID, dialer, NET, and printer, which controls where the event is sent when it takes place. Each event has a factory default setting that can be used with no additional programming.

Table 33: Default panel event settings

Panel event	Printer	Dialer	NET	CID
Aux. power 1 (disable)	Yes	None	No	500
Aux. power 1 (trouble)	Yes	Acct 1	Yes	312
Aux. power 2 (disable)	Yes	None	No	500
Aux. power 2 (trouble)	Yes	Acct 1	Yes	312
Battery charger (disable)	Yes	None	No	500
Battery charger (trouble)	Yes	Acct 1	Yes	309
Battery low (disable)	Yes	None	No	500
Battery low (trouble)	Yes	Acct 1	Yes	302
Battery missing (disable)	Yes	None	No	500
Battery missing (trouble)	Yes	Acct 1	Yes	311
Clear history	No	Acct 1	Yes	621
Common alarm	No	Acct 1	Yes	110
Common disable	No	Acct 1	Yes	500
Common monitor	No	None	No	140
Common supervisory	No	Acct 1	Yes	200
Common trouble	No	None	No	373
Common trouble for network dialer	No	None	Yes	373
Common trouble for telco dialer	No	Acct 1	No	373
Date	No	Acct 1	Yes	625
Dialer disable/remote disconnect	Yes	Acct 1	Yes	551
Dialer line 1 fault (disable)	Yes	None	No	500
Dialer line 1 fault (trouble)	Yes	Acct 1	Yes	351
Dialer line 2 fault (disable)	Yes	None	No	500
Dialer line 2 fault (trouble)	Yes	Acct 1	Yes	352

Panel event	Printer	Dialer	NET	CID
Dialer deliver fail	Yes	Acct 1	Yes	354
Dialer normal test	No	Acct 1	No	602
Dialer abnormal test	No	Acct 1	Yes	608
Dialer configuration	Yes	None	Yes	354
Drill	Yes	None	No	601
Ground fault (disable)	Yes	None	No	500
Ground fault (trouble)	Yes	Acct 1	Yes	310
Internal fault	Yes	Acct 1	Yes	307
AC power (disable)	Yes	None	No	500
AC power (trouble)	Yes	None	No	301
Net rcvr conf fault	Yes	Acct 1	No	354
Net rcvr comm fault (disable)	Yes	None	No	500
Net rcvr comm fault (trouble)	Yes	Acct 1	No	354
Panel silence	No	None	No	315
Program mode	Yes	Acct 1	Yes	627
Reset	Yes	Acct 1	Yes	305
Reset/Silence inhibit	No	None	No	000
Self test fault	No	None	No	307
Signal silence	Yes	None	No	328
System startup	Yes	None	No	000
System AC power (disable)	Yes	None	No	500
System AC power (trouble)	No	Acct 1	Yes	301
Test fire	No	None	No	604
Time	No	Acct 1	Yes	625
Walk test	Yes	Acct 1	Yes	607

To program panel events:

1. Press the menu button and choose Program.
2. Choose Advanced Program.
3. Enter a level two password.
4. Choose Panel Events.

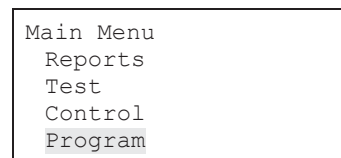

5. Select the event to be programmed.
6. Choose Event Notification.
7. Configure the event notification options. See the default settings in the table above. Not all options shown here are displayed on all systems.

Printer: Yes or No. This controls whether event information is sent to the printer

Dialer:

Acct 1 2: Event information is sent to both dialer accounts

Acct 1: Event information is sent to dialer account one

Acct 2: Event information is sent to dialer account two

None: Event information is not sent to the dialer

NET: Yes or No. Controls whether event information is sent to the connected network

CID: Contact ID event code (000 to 999)

8. When you have finished, choose Save.
9. Repeat steps 6 to 9 for each panel event.
10. Press the Menu button to exit menu mode, or continue programming.

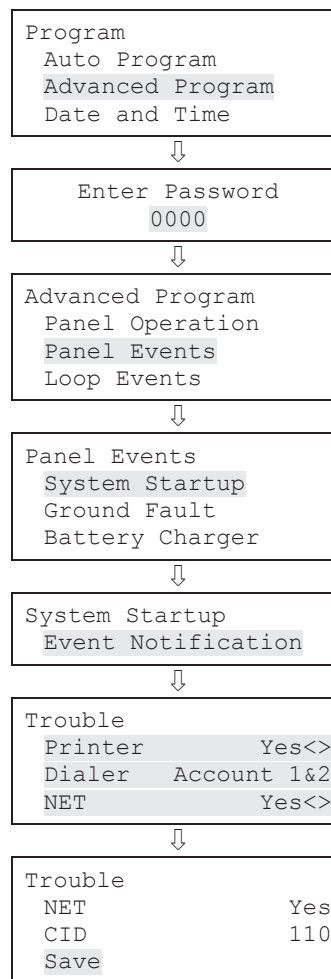

Loop event programming

Loop events, such as loop fault, map fault, and loop initialization have an event notification setting for contact ID, dialer, NET, and printer, which controls where the event is sent when it takes place. Each event has a factory default setting that can be used with no additional programming.

Table 34: Default loop event settings

Loop event	Printer	Dialer	NET	CID
Loop 1 initialization	Yes	None	No	000
Loop 1 fault (disable)	Yes	None	No	500
Loop 1 fault (trouble)	Yes	Acct 1	Yes	331
Loop 1 map fault	Yes	Acct 1	Yes	331

Loop event	Printer	Dialer	NET	CID
Loop 1 card fault (disable) (e.g. line fault)	Yes	None	No	500
Loop 1 card fault (trouble) (e.g. line fault)	Yes	Acct 1	Yes	333
Loop 1 Uncfgrd alarm (disable)	Yes	None	No	500
Loop 1 Uncfgrd alarm (trouble)	Yes	Acct 1	Yes	110
Loop 1 Uncfgrd trbl (disable)	Yes	None	No	500
Loop 1 Uncfgrd trbl (trouble)	No	None	No	331
Loop 1 map mismatch	Yes	None	No	331
Loop 1 over limits	Yes	None	No	331
Loop 1 address zero	Yes	None	No	331
Loop 1 mapping	Yes	None	No	000
Loop 2 initialization	Yes	None	No	000
Loop 2 fault (disable)	Yes	None	No	500
Loop 2 fault (trouble)	Yes	Acct 1	Yes	331
Loop 2 map fault	Yes	Acct 1	Yes	331
Loop 2 card fault (disable) (e.g. line fault)	Yes	None	No	500
Loop 2 card fault (trouble) (e.g. line fault)	Yes	Acct 1	Yes	333
Loop 2 Uncfgrd alarm (disable)	Yes	None	No	500
Loop 2 Uncfgrd alarm (trouble)	Yes	Acct 1	Yes	110
Loop 2 Uncfgrd trbl (disable)	Yes	None	No	500
Loop 2 Uncfgrd trbl (trouble)	No	None	No	331
Loop 2 map mismatch	Yes	None	No	331
Loop 2 over limits	Yes	None	No	331
Loop 2 address zero	Yes	None	No	331
Loop 2 mapping	Yes	None	No	000

To program loop events:

1. Press the Menu button and choose Programming.
2. Choose Advanced Program and enter the level 2 password.
3. Choose Loop Events.
4. Select the loop event.
5. Choose Event Notification.
6. Set the event notification. See the default settings in the table above.

Printer: Yes or No. Specifies if event information is printed

Dialer:

Acct 1 & 2: Event information is sent to both dialer accounts

Acct 1: Event information is sent to dialer account one

Acct 2: Event information is sent to dialer account two

None: Event information is not sent to the dialer

NET: Yes or No. Specifies if event information is sent to the connected network

CID: Contact ID event code (000 to 999)

7. When finished, choose Save.
8. Repeat steps 6 to 9 for each loop event.
9. Press the Menu button to exit menu mode, or continue programming.

```
Advanced Program
Panel Operation
Panel Events
Loop Events
```



```
Loop Events
Loop 1 Initializing
Loop 1 Fault
Loop 1 Map Fault
```

```
Loop 1 Initializing
Event Notification
```



```
Trouble
Printer          Yes<>
Dialer Account 1&2
NET             Yes<>
```



```
Trouble
NET          Yes<>
CID         110
```

Unconfigured alarm event programming

The unconfigured alarm event can be assigned to a correlation group and used to turn on an output device. When it is assigned to a correlation group, every unconfigured alarm event will turn on every output device in the correlation group. Event notification can also be programmed for the unconfigured alarm.

To program the unconfigured alarm event:

1. Press the Menu button and choose Programming.
2. Choose Advanced Program and enter the level 2 password.
3. Choose Unconfigured Alarm.
4. Choose Loop 1 Uncfgrd Alarm or Loop 2 Uncfgrd Alarm. (The second option is displayed only if you have more than one loop).
5. Choose Correlation Groups and enter the number of the correlation group.
6. Press Enter to toggle between possible values:
To add the event to the group, choose Included.
— or —
To remove it from the group, choose Excluded.
7. Repeat steps 7 to 9 to add or remove the event from any remaining correlation groups to be configured.
8. Choose Save.
9. Choose Event Notification.
10. Choose Active.

11. Configure active event notification. (Not all the options shown here will be displayed on all systems.)

Printer: Controls whether event information is sent to the printer. Enter toggles between Yes and No.

Coder: Four-digit coded output that is played in response to alarm conditions (00-00-00-00 to 99-99-99-99).

Dialer:

Acct 1 & 2: Event information is sent to both dialer accounts

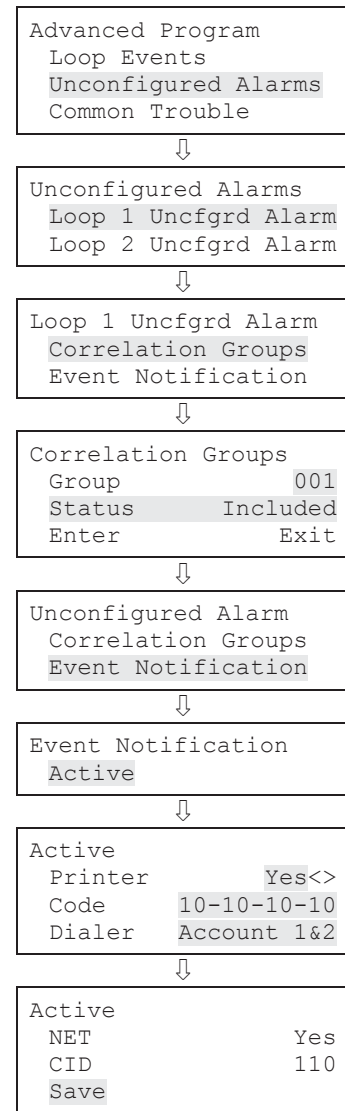

Acct 1: Event information is sent to dialer account one

Acct 2: Event information is sent to dialer account two

None: Event information is not sent to the dialer

NET: Yes or No. This controls whether event information is sent to the connected network

CID: Contact ID event code (000 to 999)

12. When you have finished, choose Save.
13. Press the Menu button to exit menu mode, or continue programming.

Common trouble event programming

The common trouble event can be assigned to a correlation group and turn on an output device. When the common trouble is assigned to a correlation group, every output device in the correlation group turns on. Event notification can also be programmed for the common trouble.

Note: Every trouble event turns on the output devices in the correlation group it is assigned to, so make sure you are not assigning the common trouble to an output group that turns on devices that you do not want to turn on (e.g. NACs).

Caution: If you do assign a NAC and the common trouble event to a correlation group and the NAC goes into trouble, when the NAC trouble clears, the NAC outputs *do not* turn off, even though the common trouble condition cleared because the NACs are not supervised. To turn off the NAC outputs, you must manually restore the NAC from the front panel's Control menu option.

To program the common trouble event:

1. Press the Menu button and choose Programming.
2. Choose Advanced Program and enter the level 2 password.
3. Choose Common Trouble.
4. Choose Trouble.
5. Choose Correlation Groups.
6. Enter the correlation group number to be programmed. (Values range from 001 to 199.).
7. Select Yes to add the common trouble to the correlation group or No to not add the common trouble to the correlation group.
8. Repeat steps 8 and 9 until the common trouble is added or removed from each correlation group needed.
9. Choose Save.
10. Choose Event Notification.
11. Choose Trouble.
12. Set trouble event notification.

Printer: Yes or No. Controls whether event information is sent to the printer.

Coder: Enter the four-digit coded output that is played in response to alarm conditions if a bell coder is installed. Values range from 00-00-00-00 to 99-99-99-99.

Dialer:

Acct 1 2: Event information is sent to both dialer accounts

Acct 1: Event information is sent to dialer account one

Acct 2: Event information is sent to dialer account two

None: Event information is not sent to the dialer

NET: Yes or No. Controls whether event information is sent to the connected network.

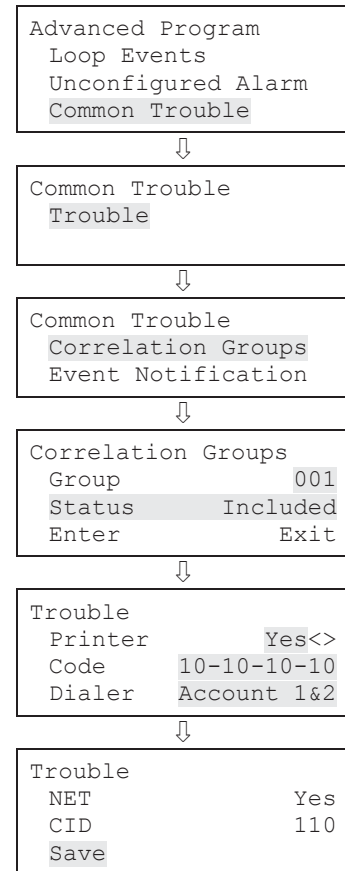

CID: Contact ID event code (000 to 999)

13. When you have finished, choose Save.
14. Press the Menu button to exit menu mode, or continue programming.

Chapter 3

System operation

Summary

This chapter covers the front panel display, operating the panel, and controlling devices, NACs, and zones.

Content

Operation overview	131
Front panel display	131
Control panel operations	131
LCD display screen	132
System normal display screen	132
System off-normal display screen	133
Event details display screens	134
System LEDs	136
LED display expander LEDs	137
Control buttons	138
Common control buttons	138
Buttons for working with menus and entering text	139
Programmable buttons (Key 1 and Key 2)	141
Programmable button function priority	142
Component descriptions	143
Events with event messages	144
Event printout examples	145
Event ID numbers and descriptions	146
Viewing event details	151
Resetting the panel	151
Silencing panel and annunciator buzzers	152

Silencing notification appliances	152
Silencing NACs manually	152
Silencing NACs automatically	152
NACs that cannot be silenced	153
Conducting a lamp test	154
Activating and restoring output devices	154
Unlatching latched output devices	155
Activating and restoring panel NACs	156
Disabling and enabling devices	156
Disabling and enabling zones	158
Disabling and enabling panel events	159
Disabling and enabling loop events	160
Disabling and enabling panel NACs	162
Disabling and enabling the dialer and network	163
Initiating a fire drill	163
Conducting a walk test	164

Operation overview

Front panel display

The front panel display is the user interface for the control panel. The display is comprised of the LCD, LED indicators, and control buttons that are used to operate and program the panel.

Figure 46: Front panel display layout

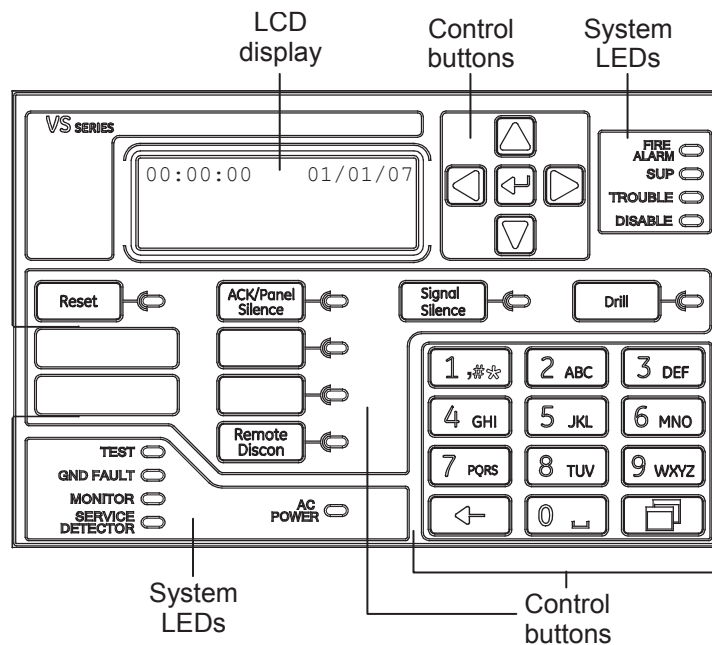

Control panel operations

The control panel operates in either normal mode or off-normal mode.

Normal mode

The panel operates in normal mode in the absence of any alarm, supervisory, trouble, or monitor events. In normal mode, the control panel monitors the system.

Off-normal mode

The panel operates in off-normal mode any time an event is introduced into the system. When this happens, the panel:

- Changes contact positions on appropriate common relays
- Activates alarm outputs (for alarm events only)

- Turns on the appropriate LEDs and the panel buzzer
- Executes the appropriate programmed output response for the input that signaled the event
- Communicates event information to the remote annunciator
- Sends a record of the event to the remote annunciator and to the control panel's history log
- Transmits event messages to a central monitoring station as programmed
- Prints event information on the printer if one is connected to the panel

LCD display screen

The liquid crystal display (LCD) is a 4-line by 20-character display that provides the user interface with the control panel for system programming, testing, report viewing, and off-normal event notification. The LCD has a backlight that turns on when a button is pushed or when an alarm event takes place in the system. When the panel is operating on battery power, the backlight automatically turns off after one minute of inactivity.

System normal display screen

The LCD shows the system normal display screen when the control panel is in the normal (quiescent) state. The screen displays the following:

- Time: Displays the current time
- Date: Displays the current date in month/day/year format
- Login: When you are logged on, "login:" with the password level is displayed in the top-right of the display, alternating with other information being displayed in that area of the screen (e.g. reset)
- Banner area: Nothing is displayed in this area unless a custom banner has been added. See "Panel operation programming" on page 117.

Figure 47: LCD under normal conditions

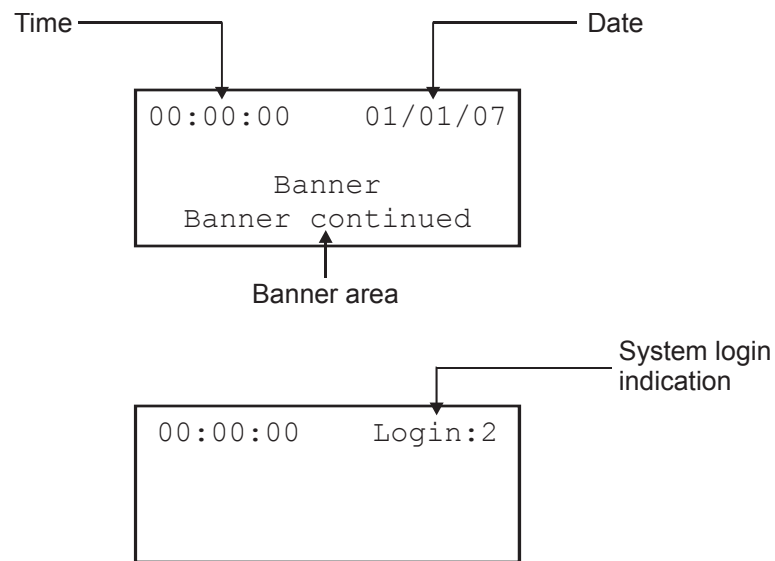

System off-normal display screen

During an off-normal event, such as an alarm, supervisory, monitor, trouble, prealarm, alarm verify, disablement, or test, the LCD screen changes to display important information about the event. The screen displays the following:

- Time: Displays the current time
- Active points: Indicates the number of active points in the system. Increments or decrements as devices activate and restore. If you are logged on, this information toggles with "login."
- Disabled points: Indicates the number of disabled points in the system. If you are logged on, this information toggles with "login."
- Event number: The event number (active point number) in queue
- Event type message: The event message for the type of event taking place
- Device label: The label for the device, either the default label or a custom programmed label

Figure 48: LCD under off-normal conditions

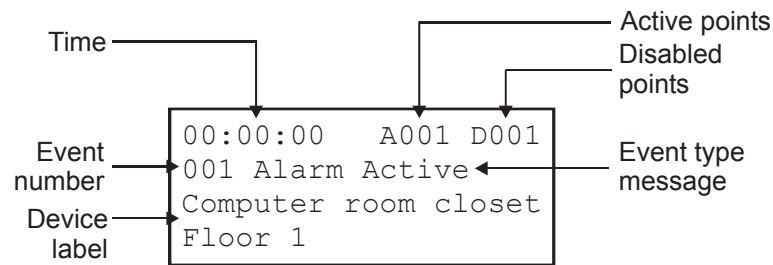

Event details display screens

The off-normal events that take place in the system contain event information that is displayed on the LCD screen. Additional information is available on a secondary screen. The screen displays the following information based on the type of event that takes place:

- Loop number: The loop the device is on
- Device number: The device address (number)
- Device type: The type of device that was assigned in programming
- Serial number: The serial number assigned to the device
- Internal event number: See “Event ID numbers and descriptions” on page 146
- Zone number and device label for devices in zones
- Annunciator number and label
- Other information when it is available

Figure 49: Device event details display screen

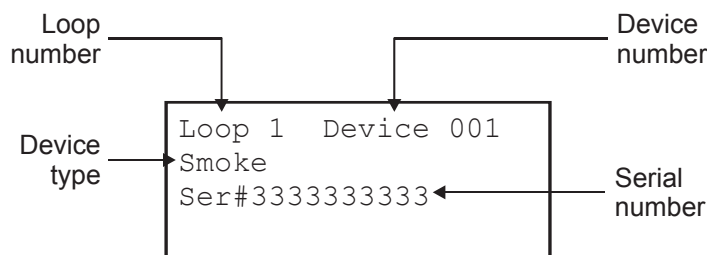
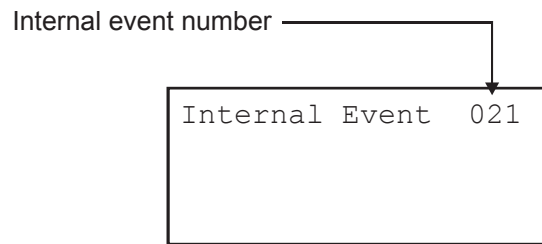
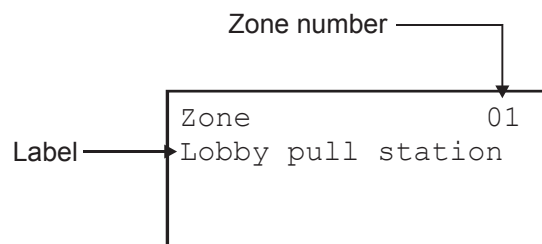

Figure 50: Internal event (panel and loop events) details display screen



Note: See “Event ID numbers and descriptions” on page 146 for a list of event numbers.

Figure 51: Zone event details display screen



Note: You can scroll through the list of all devices in the zone reporting an event.

Figure 52: Annunciator event details display screen

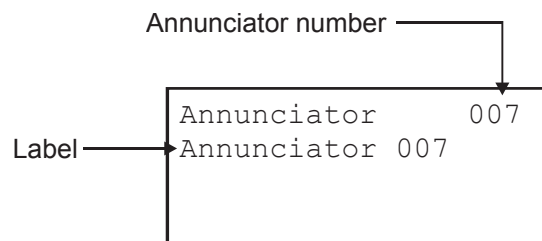

To view event details:

1. When an event takes place, press Enter on the front panel.
2. View the event details.

The event details screen is displayed for 15 seconds and then returns to the previous screen if there is no activity.

System LEDs

LEDs indicate system events and system operation.

Table 35: System LEDs

LED	Description
Fire Alarm	Red LED. Flashes when there is an active alarm event on any loop. On steady once acknowledged.
Trouble	Yellow LED. Flashes when there's a fault with a monitored circuit or system component or when a circuit is disabled. On steady once acknowledged.
Sup	Yellow LED. Flashes when there is an active supervisory event on any loop. On steady once acknowledged.
AC Power	Green LED. On when the panel has AC power.
Disable	Yellow LED. Double-flashes when there is a disabled circuit or alarm relay.
Ground Fault	Yellow LED. On steady during an active ground fault.
Test	Yellow LED. Flashes when performing an audible walk test. Steady indicates a silent test.
Monitor	Yellow LED. Flashes when there is an active monitor event on any loop. On steady once acknowledged.
Service Detector	Yellow LED. Indicates that detector needs servicing.
Signal Silence	Yellow LED. On steady indicates that NAC circuits are turned off but the panel is still in alarm.
Remote Disconnect	Yellow LED. On steady indicates that the CMS devices (dialer and network card) are disabled or that the alarm relay is enabled or disabled when the dialer is set to modem only.
Drill	Yellow LED. Indicates that the panel is in drill.
Reset	Yellow LED. Indicates that the panel is going through a reset.
Panel Silence	Yellow LED. Indicates that the panel has been silenced during an active trouble, supervisory, monitor, or alarm event and indicates that new event activations have been acknowledged.
User keys	Yellow LED. Indicates that the programmed key function is active.

LED display expander LEDs

The D16L-VS LED Display Expander provides LED annunciation for up to 16 zones. The expander provides two LEDs for each zone. Two LED display expanders can be installed in the panel.

LED operation zones 1 through 12 (and 17 through 28 if the second LED expander is installed)

- LED 1 - Alarm: Red LED flashes
- LED 2 - Trouble: Yellow LED flashes

LED operation zones 13 through 16 (and 29 through 32 if the second LED expander is installed)

- LED 1 - Bicolor
Alarm: Red LED flashes
Non-alarm active: Yellow LED flashes
- LED 2 - Trouble: Yellow LED flashes

Figure 53: LED zone designations

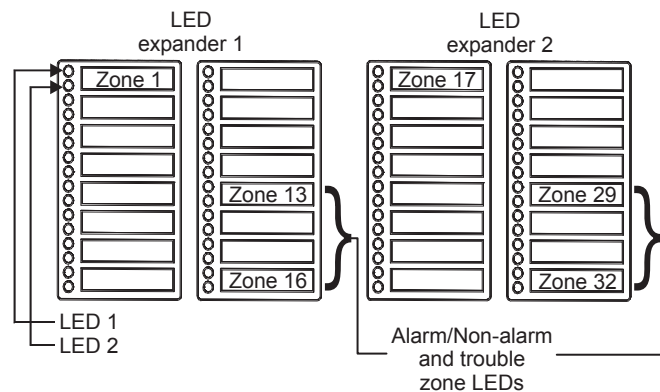

Control buttons

Common control buttons

Common control buttons on the front panel perform a variety of functions. Table 36 below identifies the common controls and describes their functions.

Table 36: Common controls

Button	Description
Reset	Initiates a system reset. The button LED indicates the function is active.
ACK/Panel Silence	Silences the panel and annunciator sounders during an active trouble, supervisory, or alarm event and acknowledges new event activations. The button LED indicates the function is active.
Remote Disconnect	<p>CMS devices (dialer and network card): Disables or enables the dialer and network CMS connection and purges all pending event transmission to the CMS. Has no effect on the alarm relay.</p> <p>Dialer set to modem only (and no network card CMS configured): Disables or enables the common alarm relay.</p> <p>Systems with a panel or device NAC configured as city tie: Disables or enables the city tie NACs.</p> <p>The button LED indicates that the function is active.</p> <p>Note: A minimum of a level one password is required to operate.</p>
Signal Silence	Silences notification appliances activated by an alarm condition. Pressing Signal Silence a second time turns NACs back on. The button LED indicates when the panel is in alarm and operating with notification appliances turned off. Visual appliances may or may not turn off when Signal Silence is pressed depending on panel programming.
Drill	<p>Initiates a drill when the button is pressed for two seconds. The button LED indicates the function is active.</p> <p>Pressing drill a second time turns off the drill function</p> <p>Note: Drill will not operate with an active alarm or supervisory event at the panel.</p>

Buttons for working with menus and entering text

Table 37 below describes the menu command buttons and the buttons on the alphanumeric keyboard.

The alphanumeric keypad is used to enter passwords, create text labels, and enter device and group numbers. Values appear on the LCD screen as you press the button.





Note: Numeric buttons have multiple values. Each number button can be used to enter multiple values. For example, the “2” button can be used to enter either the number 2 or the letter A, B, or C.

To enter text, numbers, or symbols:

1. Press the button once to enter the number, or press again to scroll through the alternate values. Wait for the cursor to move to the next position.
2. Enter the next number, character, or symbol.
3. When you have finished, press the Enter button.

Table 37: Buttons for working with menus and entering text

Button	Description
Menu 	Opens and exits menu mode
Left Arrow	Moves the cursor to the left (when the panel is in display mode) Scrolls through the available values for a programming option (when the panel is in menu mode)
Right Arrow	Moves the cursor to the right (when the panel is in display mode) Opens a submenu or scrolls through available values for a programming option (when the panel is in menu mode)
Up Arrow	Scrolls back to the previous event (when the panel is in display mode) Moves the cursor up (when the panel is in menu mode)
Down Arrow	Scrolls forward to the next event (when the panel is in display mode) Moves the cursor down (when the panel is in menu mode)

Button	Description
Enter	<p>Displays detailed information about the selected event (when the panel is in display mode)</p> <p>Opens a submenu or jumps to the Save function in the menu so you can quickly save your changes (when the panel is in menu mode)</p> <p>Enters the selected data into the system (when you are entering data)</p>
	
Cancel	<p>Returns to the previous screen</p> <p>Erases the previous character (when you are entering data)</p> <p>Exits the detailed information display and returns to the event list (when the panel is in display mode)</p> <p>Returns to the previous menu level or (if you are at the highest menu level) exits menu mode</p> <p>Clears the current entry and moves the cursor to the left (when you are entering data)</p> <p>Exits entry mode and returns to menu mode (if the cursor is at the leftmost position)</p>
	
Space	<p>Enters the number "0" (when pressed once)</p> <p>Enters a space (when pressed twice)</p>
	
Symbol	<p>Enters the symbol "#" (when pressed once)</p> <p>Enter the "*" symbol (when pressed twice)</p> <p>Enters a comma (when pressed three times)</p>
	

Programmable buttons (Key #1 and Key #2)

Two unlabeled control buttons on the front panel can be programmed to operate the LCD and perform the functions listed in Table 38 below. The buttons can be labeled as to their function with a slip-in label. Operating the buttons requires a minimum level 2 password.

Table 38: Functions available for programmable buttons (Key #1 and K#2)

Function	Description
Activate	<p>The first press turns on outputs in any number of correlation groups. The button LED turns on.</p> <p>The second press turns off these same outputs and the button LED.</p>
Disable	<p>The first press disables any number of correlation groups, correlation group members, or both. The button LED turns on.</p> <p>The second press enables the same set of correlation groups and correlation group members and turns off the button LED.</p> <p>Note: The Disable function operates differently based on the whether you choose Correlation Groups, Members of Correlation Group, or Both. The default value is Members.</p> <ul style="list-style-type: none"> If you choose Disable Correlation Group: <ul style="list-style-type: none"> An LCD message indicates that Corr Grp xxx is disabled All outputs (including relay and sounder bases) are turned off and the disabled correlation group stops operating. Note: Detector bases that have been activated by their attached sensors cannot be disabled through group disable operation. If you choose Members of Correlation Group: <ul style="list-style-type: none"> An LCD message identifies the Disabled members. <p>Notes</p> <p>Disabling members of a correlation group does not disable relay or sounder bases.</p> <p>Active devices cannot be enabled through a programmable button. To enable these devices, press the Menu button and choose Control>Enable Device.</p> <ul style="list-style-type: none"> If you choose Both: <ul style="list-style-type: none"> The correlation group stops operating and all members are disabled. An LCD message identifies the Disabled members.
Unlatch	Unlatches all latched outputs system-wide
Restore	Restores outputs in any number of correlation groups to their normal state. (Disabled or latched devices must be enabled or unlatched before they can be restored.)
None	Removes any function associated with the button.

Programmable button function priority

- Operations such as Signal Silence, Auto Signal Silence, and Drill take priority over Activate, Restore, and Disable.
- Activate, Restore, and Disable take priority over In Suite Signal Silence.
- A single Restore or Disable takes priority over one or more Activates.
- Restore or Group Disable only affect devices from correlation groups that have been added to the list for that button.
- Although an Activate button can turn on both latched and unlatched devices, it can only turn off unlatched devices. Latched outputs remain active until you press a button programmed for Unlatch. Until the output has been unlatched, the panel displays an “Outputs are Latched” monitor event message.
- The Disable and Restore commands do not affect active latched outputs until after the Unlatch button has been pressed. Until the output has been unlatched, the panel displays an “Outputs are Latched” monitor event message.

Component descriptions

The control panel contains the following components.

Figure 54: Component layout

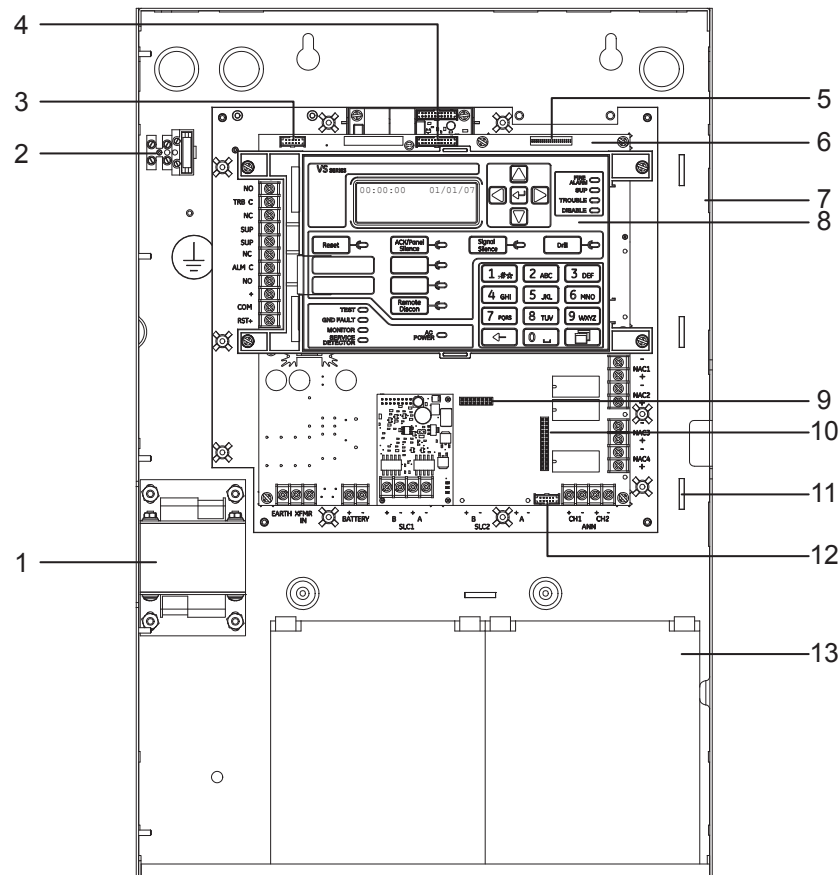

Item	Description
1	Transformer: Changes 120 or 230 volt AC supply voltage to 24 volt AC.
2	Main AC wiring block and fuse holder: Provides connections for 120 or 230 volt AC (primary power) from dedicated service. Includes a primary power fuse (5 A).
3	RS-232 card connector (J3): Provides a connection for the optional RS-232 card for connecting a printer or downloading from the configuration utility.
4	Dialer card connection (J8): Provides a connection for the optional dialer card.
5	Ethernet card connector (J1): Provides a connection for the optional Ethernet card.
6	Main circuit board: Provides connections for all circuits. Also includes the operator interface.
7	Cabinet enclosure: Houses the panel electronics and standby batteries. In some cases, the batteries may be housed in an external battery cabinet (BC-3).

Item	Description
8	Operator interface: Includes operator controls, LED indicators, and control buttons
9	Loop expander card connector (J14): Provides a connection for the optional loop expander card (only on the VS2 panel).
10	Class A card connector (J2): Provides a connection for the optional Class A card (only on the VS1 panel)
11	Tie wrap mounts: Used to secure wires and to help maintain proper separation between power-limited and nonpower-limited conductors
12	LED expander connector (J6): Provides a connection for the optional LED expander
13	Standby batteries: Provide secondary/standby power to the panel electronics in the absence of primary power

Events with event messages

Table 39: Events with event messages

Event type		LCD	Printer [1]
Alarm	Active type reporting		
	Input smoke	Alarm active	SMK ACT
	Input smoke verified	Alarm active	SMK ACT
	Input heat	Heat alarm	HEAT ACT
	Input heat rate of rise	Heat alarm	HEAT ACT
	Input duct alarm	Alarm active	DUCT ACT
	Input pull station	Pull station alarm	PULL ACT
	Input water flow	Water flow	WFLW ACT
	Input water flow retard	Water flow	WFLW ACT
	Zone alarm	Alarm active	ALRM ACT
	Zone water flow	Alarm active	ALRM ACT
	Supervisory type reporting		
	Input duct alarm	Supervisory	DUCT ACT
	Zone supervisory	Supervisory	SUPV ACT
Input supervisory latching	Supervisory	SUPV ACT	
Input supervisory nonlatching	Supervisory	SUPV ACT	

Event type		LCD	Printer [1]
	Monitor type reporting		
	Zone monitor	Monitor	MON ACT
	Input monitor	Monitor	MON ACT
	Outputs are latched	Outputs are latched	Outputs are latched
	Prealarm reporting	Pre-alarm	PALM ACT
	Alarm verify reporting	Alarm verify	ALMV ACT
	Maintenance alert reporting	Maint. alert	MANT ACT
Trouble	All devices	Trouble	TRBL ACT
Disable	All devices	Disable	DSBL ACT
Test	All devices	Test	TEST ACT

[1] See “Event printout examples” below for an example of how events appear when printed.

Event printout examples

Event information is printed each time an event takes place provided a printer is connected to the system. The following is an example of what the event information looks like on the printout and a description of each piece of information printed for an event.

Annunciator event

```
TRBL ACT | 18:00:07 01/01/2007      A:008
Annunciator 08
```

Where:

TRBL ACT = Trouble event

18:00:07 01/01/2007 = Time and date the event took place

A:008 = Annunciator 08

Annunciator 08 = Label (could be the default label or a custom label)

Internal event (panel or loop event)

```
MON ACT | 18:00:18 01/01/2007      E:010
Loop 2 Initializing
```

Where:

MON ACT = Monitor event

18:00:18 01/01/2007 = Time and date the event took place

E:010 = Event 010 (see “Event ID numbers and descriptions” on page 146)

Loop 2 initializing = Label (could be the default label or a custom label)

Zone event

ALRM ACT | 18:00:34 01/01/2007 Z:008
Zone 08

Where:

ALRM ACT = Alarm event

18:00:34 01/01/2007 = Time and date the event took place

Z:008 = Zone 08

Zone 08 = Label (could be the default label or a custom label)

Device event

ALRM ACT | 18:00:34 01/01/2007 L:1 D:128
Loop 1 Device 128

Where:

ALRM ACT = Alarm event

18:00:34 01/01/2007 = Time and date the event took place

L:1 = Loop 1

D:128 = Device 128

Loop 1 Device 128 = Label (could be the default label or a custom label)

Event ID numbers and descriptions

Table 40: Event ID numbers and descriptions

Event ID	Event description	Event ID	Event description
000	Loop 1 initialization: Loop 1 is starting up	052	Dialer deliver fail: The dialer failed to deliver a message to the receiver or CMS
001	Loop 1 fault: A short or open was detected on loop 1 affecting the communications between the panel and the devices on the loop	053	Dialer normal test: A dialer test was conducted when the panel was in a normal state
002	Loop 1 map fault: A mapping fault was detected on loop 1 while the panel was mapping the devices	054	Dialer abnormal test: A dialer test was conducted when the panel was in an off normal state
003	Loop 1 card fault: The loop 1 card is not present or it is not working properly	055	Dialer configuration: The dialer is not programmed or has unverified changes
004	Loop 1 uncfgd alarm: A device on loop 1 that is not programmed went into alarm	056	Net recvr comm fault: Communications between the panel and the network receiver failed

Event ID	Event description	Event ID	Event description
005	Loop 1 uncfgd trouble: A device on loop 1 that is not programmed went into trouble	057	Net recvr config fault: The panel failed to communicate with the network receiver after a configuration change
006	Loop 1 map mismatch: The loop 1 map in RAM and the loop 1 map in the database do not match	058	NAC 1 trouble: An open or short has been detected on NAC 1 or there is a problem with the EOL
007	Loop 1 over limits: There are too many devices on loop 1	059	NAC 2 trouble: An open or short has been detected on NAC 2 or there is a problem with the EOL
008	Loop 1 device 000: A device on loop 1 has an address set to zero	060	NAC 3 trouble: An open or short has been detected on NAC 3 or there is a problem with the EOL
009	Loop 1 mapping: Loop 1 is mapping devices	061	NAC 4 trouble: An open or short has been detected on NAC 4 or there is a problem with the EOL
010	Loop 2 initialization: Loop 2 is starting up	062	Printer trouble: The printer is either offline, out of paper, or disconnected
011	Loop 2 fault: A short or open was detected on loop 2 affecting the communications between the panel and the devices on the loop	063	Annunciator 1 trouble: An open or short has been detected on annunciator 1
012	Loop 2 map fault: A mapping fault was detected on loop 2 while the panel was mapping the devices	064	Annunciator 2 trouble: An open or short has been detected on annunciator 2
013	Loop 2 card fault: The loop 2 card is not present or it is not working properly	065	Annunciator 3 trouble: An open or short has been detected on annunciator 3
014	Loop 2 uncfgd alarm: A device on loop 2 that is not programmed went into alarm	066	Annunciator 4 trouble: An open or short has been detected on annunciator 4
015	Loop 2 uncfgd trouble: A device on loop 2 that is not programmed went into trouble	067	Annunciator 5 trouble: An open or short has been detected on annunciator 5
016	Loop 2 map mismatch: The loop 2 map in RAM and the loop 2 map in the database do not match	068	Annunciator 6 trouble: An open or short has been detected on annunciator 6
017	Loop 2 over limits: There are too many devices on loop 2	069	Annunciator 7 trouble: An open or short has been detected on annunciator 7
018	Loop 2 device 000: A device on loop 2 has an address set to zero	070	Annunciator 8 trouble: An open or short has been detected on annunciator 8

Event ID	Event description	Event ID	Event description
019	Loop 2 mapping: Loop 2 is mapping devices	071	Zone 1 (active, trouble, disable, prealarm, alarm verify, maintenance alert, or test has been detected on zone 1)
020	System startup: The control panel is starting up	072	Zone 2 (active, trouble, disable, prealarm, alarm verify, maintenance alert, or test has been detected on zone 2)
021	Program mode: The control panel is in program mode	073	Zone 3 (active, trouble, disable, prealarm, alarm verify, maintenance alert, or test has been detected on zone 3)
022	Reset: The control panel is resetting	074	Zone 4 (active, trouble, disable, prealarm, alarm verify, maintenance alert, or test has been detected on zone 4)
023	Reset/Sil inhibit: Reset/silence inhibit is activated	075	Zone 5 (active, trouble, disable, prealarm, alarm verify, maintenance alert, or test has been detected on zone 5)
024	Panel silence: The control panel buzzer has been silenced	076	Zone 6 (active, trouble, disable, prealarm, alarm verify, maintenance alert, or test has been detected on zone 6)
025	Signal silence: The control panel NACs have been silenced	077	Zone 7 (active, trouble, disable, prealarm, alarm verify, maintenance alert, or test has been detected on zone 7)
026	Drill: The control panel is in the drill state	078	Zone 8 (active, trouble, disable, prealarm, alarm verify, maintenance alert, or test has been detected on zone 8)
027	Walk test: The control panel is in the walk test state	079	Zone 9 (active, trouble, disable, prealarm, alarm verify, maintenance alert, or test has been detected on zone 9)
028	Test fire: A smoke or heat detector is being tested	080	Zone 10 (active, trouble, disable, prealarm, alarm verify, maintenance alert, or test has been detected on zone 10)
029	Clear history: The control panel's event history has been cleared	081	Zone 11 (active, trouble, disable, prealarm, alarm verify, maintenance alert, or test has been detected on zone 11)

Event ID	Event description	Event ID	Event description
030	Time: The control panel's time was modified	082	Zone 12 (active, trouble, disable, prealarm, alarm verify, maintenance alert, or test has been detected on zone 12)
031	Date: The control panel's date was modified	083	Zone 13 (active, trouble, disable, prealarm, alarm verify, maintenance alert, or test has been detected on zone 13)
032	Common disable: A disable event is taking place on the control panel	084	Zone 14 (active, trouble, disable, prealarm, alarm verify, maintenance alert, or test has been detected on zone 14)
033	Common trouble: A trouble event is taking place on the control panel	085	Zone 15 (active, trouble, disable, prealarm, alarm verify, maintenance alert, or test has been detected on zone 15)
034	Ground fault: The panel detected a ground fault	086	Zone 16 (active, trouble, disable, prealarm, alarm verify, maintenance alert, or test has been detected on zone 16)
035	Battery charger: The panel detected a battery charger trouble condition. The charger may not be able to charge the batteries.	087	Zone 17 (active, trouble, disable, prealarm, alarm verify, maintenance alert, or test has been detected on zone 17)
036	Battery low: The batteries are low on charge	088	Zone 18 (active, trouble, disable, prealarm, alarm verify, maintenance alert, or test has been detected on zone 18)
037	Battery missing: The battery is no longer connected	089	Zone 19 (active, trouble, disable, prealarm, alarm verify, maintenance alert, or test has been detected on zone 19)
038	AC power: There is a problem with the panel's AC power	090	Zone 20 (active, trouble, disable, prealarm, alarm verify, maintenance alert, or test has been detected on zone 20)
039	Aux. power 1: The control panel detected a trouble condition on the continuous AUX power circuit 1	091	Zone 21 (active, trouble, disable, prealarm, alarm verify, maintenance alert, or test has been detected on zone 21)
040	Aux. power 2: The control panel detected a trouble condition on the resettable AUX power circuit 2	092	Zone 22 (active, trouble, disable, prealarm, alarm verify, maintenance alert, or test has been detected on zone 22)

Event ID	Event description	Event ID	Event description
041	System AC power: There is a problem with the panel's AC power and/or a remote auxiliary/booster's AC power	093	Zone 23 (active, trouble, disable, prealarm, alarm verify, maintenance alert, or test has been detected on zone 23)
042	Common alarm: An alarm event is taking place on the control panel	094	Zone 24 (active, trouble, disable, prealarm, alarm verify, maintenance alert, or test has been detected on zone 24)
043	Common supervisory: A supervisory event is taking place on the control panel	095	Zone 25 (active, trouble, disable, prealarm, alarm verify, maintenance alert, or test has been detected on zone 25)
044	Common monitor: A monitor event is taking place on the control panel	096	Zone 26 (active, trouble, disable, prealarm, alarm verify, maintenance alert, or test has been detected on zone 26)
045	Common trouble for telco dialer: A trouble event, other than a DACT delivery fault is taking place on the control panel	097	Zone 27 (active, trouble, disable, prealarm, alarm verify, maintenance alert, or test has been detected on zone 27)
046	Common trouble for network dialer: A trouble event, including a DACT delivery fault is taking place on the control panel	098	Zone 28 (active, trouble, disable, prealarm, alarm verify, maintenance alert, or test has been detected on zone 28)
047	Self test fault: A fault has been detected while testing the panel's internal subsystems (memory, flash, code, etc.)	099	Zone 29 (active, trouble, disable, prealarm, alarm verify, maintenance alert, or test has been detected on zone 29)
048	Internal fault: The control panel detected an internal hardware or software error	100	Zone 30 (active, trouble, disable, prealarm, alarm verify, maintenance alert, or test has been detected on zone 30)
049	Dialer dsbl/rem disc: The dialer was disabled by the Remote Disconnect button	101	Zone 31 (active, trouble, disable, prealarm, alarm verify, maintenance alert, or test has been detected on zone 31)
050	Dialer line 1 fault: A ground fault or line fault has been detected on line 1 of the dialer	102	Zone 32 (active, trouble, disable, prealarm, alarm verify, maintenance alert, or test has been detected on zone 32)
051	Dialer line 2 fault: A ground fault or line fault has been detected on line 2 of the dialer		

Viewing event details

The off-normal events that take place in the system contain event information that is displayed on the LCD screen. Additional information is available on a secondary screen called the Event Details screen.

To display the event details screen:

1. When an event takes place, press Enter on the front panel.
2. View the event details.

For a description of the information displayed on the screen, see “LCD display screen” on page 132. The event details screen is displayed for 15 seconds if there is no activity and then returns to the previous screen.

Note: Use the up and down arrow keys to scroll through multiple events.

Resetting the panel

Pressing Reset restores the fire alarm system to the normal state provided there are no active devices or circuits. The Reset command does not restore disabled or latched devices: Disabled devices must be enabled and latched output devices must be unlatched before they can be restored. Also, if signal silence inhibit or reset inhibit is enabled, the system will not restore until the silence or reset inhibit period elapses.

WARNING: To avoid possible injury or loss of life, do not reset the fire alarm system until the appropriate authority determines that it is safe to do so.

To reset the panel:

1. Press the Reset button.

When you reset the panel:

- “Reset” is displayed on the top-right of the LCD.
- The Reset LED lights.
- Devices in an off-normal state remain in their off-normal state until the element causing their off-normal state clears.
- When the reset process is complete, “Reset” clears from the LCD and the Reset LED turns off.

Silencing panel and annunciator buzzers

The panel buzzer sounds whenever an event message is received at the control panel. Pressing the Panel Silence button:

- Silences the panel buzzer on the control panel
- Acknowledges all current event messages
- Silences the panel buzzer on all remote annunciators

To silence the panel buzzer:

1. Press the Ack/Panel Silence button.
2. Determine whether the buzzer sounded in response to an alarm, trouble, supervisory, or monitor event.
3. Determine the cause of the event.

Silencing notification appliances

WARNING: Do not silence notification appliances until the building is fully evacuated and the cause of the alarm has been determined.

To silence or resound notification appliances:

1. Press the Signal Silence button.

Silencing NACs manually

Pressing the Signal Silence button turns off all silenceable NACs, including audibles and visibles, depending on system programming. See “Programming in-suite signal silence” on page 83.

When you silence the signals:

- The Signal Silence LED lights, indicating that the notification appliances are off
- If Genesis horn/strobe or horn-only devices are used on NACs programmed for Genesis operation, Signal Silence silences the horns and strobes based on system programming

Silencing NACs automatically

Two options let you silence NACs automatically: Auto Signal Silence and Suite Signal Silence (in-suite signal silence). Both work by starting a timer when an event activates

the NACs. The NACs are allowed to sound until the timer expires, after which they are automatically silenced.

The Auto Signal Silence option

Auto Signal Silence can be enabled when programming the panel. It affects all silenceable NACs connected to the panel. The elapsed time can be set for 5 to 30 minutes. See “Disabling and enabling devices” on page 156.

The Suite Signal Silence option

The Suite Signal Silence option enables or disables in-suite signal silence for the selected correlation group. This option affects only silenceable NACs associated with the correlation groups. For more information on this programming this option, see “Programming in-suite signal silence” on page 83.

NACs that cannot be silenced

NACs configured as latched outputs cannot be silenced. This includes any device configured as:

- Continuous Non-Silenceable Latched (Cont NS Latch)
- Supervised Outputs Latched (SupOut Latch)
- Continuous Non-Silenceable Class A Latched (Cont NS CIA Latch)
- Supervised Outputs Class A Latched (SupOut CIA Latch)

In addition, NACs activated by devices programmed as waterflow cannot be silenced until the activated devices are restored to normal via a panel reset. After the waterflow device events restore, the Signal Silence button or the auto signal silence timer can silence the NACs if there are other events causing the NACs to activate. Waterflow activations do not invoke in-suite signal silence.

Conducting a lamp test

A lamp test lights all of the LEDs on the panel and the LED annunciator and tests the LCD so that you can verify proper operation. LEDs stay on for 15 seconds.

To conduct a lamp test:

1. Display the Test. menu
2. Choose Lamp Test.
3. Press Enter.
4. Verify that all LEDs on the panel, the LCD, and the LED annunciator (if used) work properly.

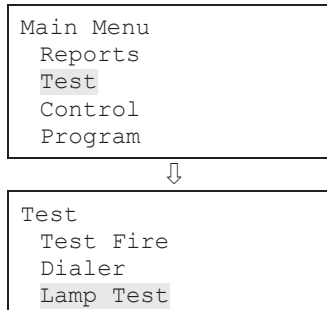

Activating and restoring output devices

Activating an output device on a signaling line circuit (SLC) turns on its output. This is typically done to test individual strobes, horns, and other notification appliances. Restoring the device turns it off again.

Notes

- Input devices cannot be activated. If you attempt to activate an input device, the message “Invalid device” is displayed.
- Disabled devices must be manually enabled and then restored. See “Disabling and enabling devices” on page 156.
- Latched outputs must be manually unlatched and then restored. See “Unlatching latched output device” on page 155.

To activate or restore an output device:

1. Press the menu button and choose Control.
2. Enter a level one password.
3. Choose Activate/Restore.
4. Choose Device.
5. Choose the loop the device is on.

Note: If the panel only has one loop, the loop selection screen does not display. Go to the next step.
6. Enter the device ID for the device that you want to activate or restore.
7. Press Enter.
8. Press Cancel to return to the previous menu.

— or —

Press the Menu button to exit menu mode.

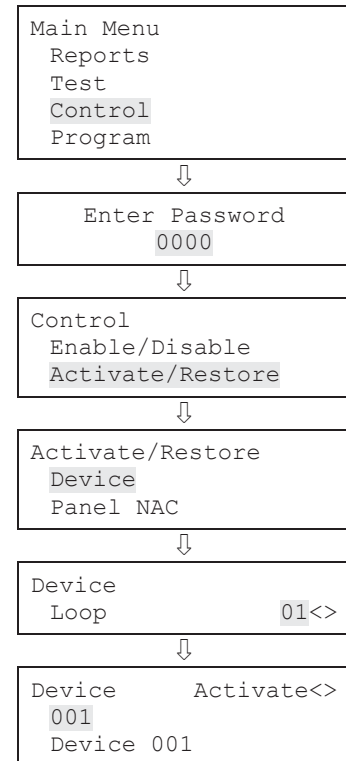

Unlatching latched output devices

Latched outputs are devices that are configured to shut down air handlers and dampers automatically when an alarm activates, and to keep them shut down until they are manually unlatched and restored. For this reason, devices configured as latched output devices must be manually unlatched and then restored.

When outputs are latched, the panel generates an “Outputs are latched” event. The unlatch command affects all latched output devices system-wide. You can assign the Unlatch Outputs command to a programmable key on the front panel or to a Class A or B Signature input module circuit with one of the devices listed on page 96.

To unlatch latched output devices:

1. Press the Unlatch Outputs button on the control panel (if programmed).

— or —

Press the Unlatch Outputs module button (if programmed).

Activating and restoring panel NACs

Activating a notification appliance circuit (NAC) turns on its outputs. Restoring the NAC turns them off again. This is typically done for testing purposes.

Note: Disabled NACs must be manually enabled and then restored. See “Disabling and enabling devices” below.

To activate a panel NAC:

1. Press the menu button and choose Control.
2. Enter a level one password.
3. Choose Activate/Restore.
4. Choose Panel NAC.
5. Select the NAC that you want to activate.
6. Press Enter.
7. Press Cancel to return to the previous menu.

— or —

Press the Menu button to exit menu mode.

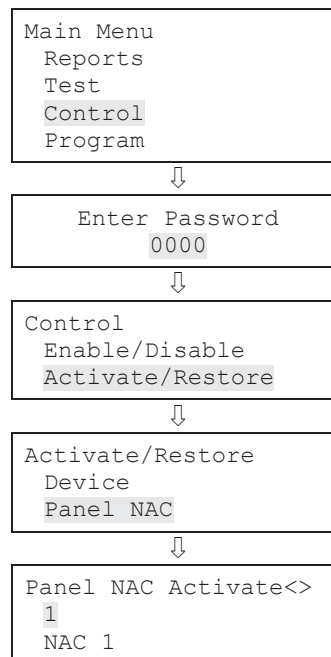

Notes

- Disabled devices must be manually enabled and then restored. See “Disabling and enabling devices” below.
- Latched output devices must be manually unlatched and then restored. See “Unlatching latched output device” on page 155.

Disabling and enabling devices

Disabling a device does not prevent it from activating, but does prevent event messages originating from the device from being displayed, printed, or reported off-premises. Devices are typically disabled during maintenance. Remember to re-enable the device as soon as you have finished working with it.

Notes: The Reset command does not restore disabled or latched devices: Disabled devices must be enabled and latched output devices must be unlatched before they can be restored.

When a device is disabled:

- If the device you are disabling is active, a warning message is displayed.
- The common Disable LED turns on.
- The LCD displays a message indicating that the device is disabled.
- The common Trouble LED flashes and the panel goes into a trouble state.
- The common Trouble relay changes state.
- The disabled and active points indicators on the LCD increment.
- Resetting the panel has no effect on disabled devices, but removing all power from the panel clears the disable and enables the device.

To disable or enable a device:

1. Press the menu button and choose Control.
2. Enter a level one password.
3. Choose Enable/Disable.
4. Choose Device.
5. Choose the loop the device is on.

Note: If the panel only has one loop, the loop selection screen does not display. Go to the next step.
6. Enter the device ID for the device that you want to disable or enable.
7. Press Enter.
8. If the device is active, acknowledge the warning message by selecting Continue to disable the device or Cancel to exit.

The device is disabled and a message indicating that the device is disabled is displayed on the LCD.

9. Press Cancel to return to the previous menu.

— or —

Press the Menu button to exit menu mode.

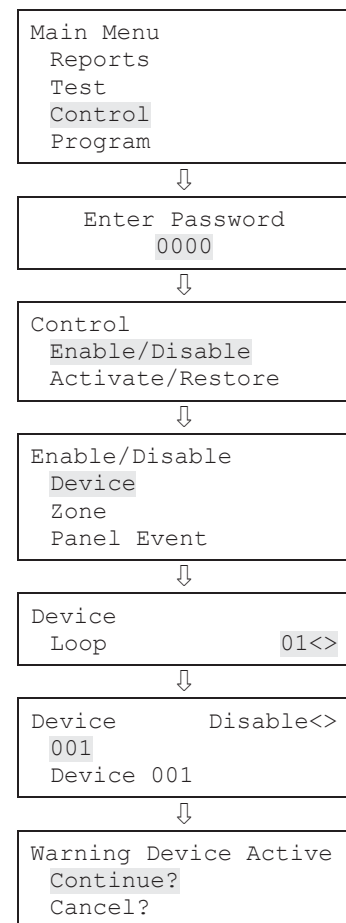

Disabling and enabling zones

Zones are typically disabled while maintenance is performed to prevent event messages originating from the zone from being displayed, printed, or reported off-premises. Disabling a zone does not prevent activations in the zone. All devices in the zone continue to function normally.

Note: Remember to re-enable the zone as soon as you have finished working with it. Resetting the panel does not restore disabled zones. These must be manually enabled and then restored.

When you disable a zone:

- The common Disable LED turns on
- On a zone/device system, the LCD displays disabled messages for the zone and all of the devices in the zone
- On a zone only system, the LCD displays a disabled message for the zone
- The common trouble LED flashes and the panel goes into a trouble state
- The common trouble relay changes state
- The disabled and active points indicators on the LCD increment
- If you are using an LED display expander, the zone LEDs blink for the zone
- Resetting the panel has no effect on a disabled zone, but removing all power from the panel enables the zone.
- If the zone you are disabling contains devices that are active, a warning message is displayed.

To disable or enable a zone:

1. Press the menu button and choose Control.
2. Enter a level one password.
3. Choose Enable/Disable.
4. Choose Zone.
5. Select the zone that you want to disable or enable.
6. Press Enter.
7. If devices in the zone are active, acknowledge the warning message by selecting Continue to disable the zone or Cancel to exit.
The zone is disabled.
8. Press Cancel to return to the previous menu.

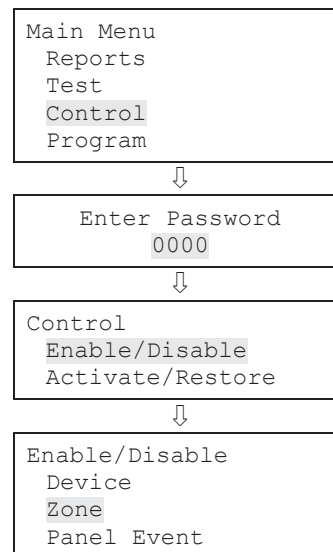

— or —

Press the Menu button to exit menu mode.

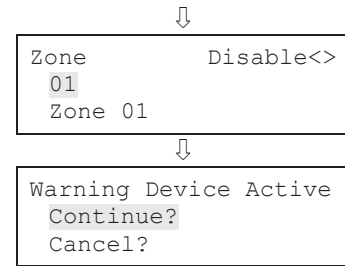

Disabling and enabling panel events

Disabling a panel event prevents the messages that are sent when the event occurs from being displayed, printed, or reported off-premises. Events are typically disabled while maintenance is performed. Remember to re-enable the event as soon as you have finished working.

Note: Not all panel events can be disabled. Panel events that cannot be disabled are labeled as “forbidden.” The following table lists panel events that can be disabled:

Table 41: Panel events that can be disabled

Event	ID
Ground fault	034
Battery charger	035
Battery low	036
Battery missing	037
AC power	038
System AC power	041
Aux. power 1	039
Aux. power 2	040
Dialer line 1 fault	045
Dialer line 2 fault	046
Net receiver communication fault	051

To disable or enable a panel event:

1. Press the menu button and choose Control.
2. Enter a level one password.
3. Choose Enable/Disable.
4. Choose Panel Event.

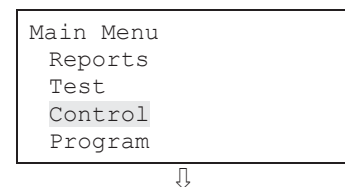

5. Enter the ID number of the event type to disable or enable.

See “Event ID numbers and descriptions” on page 146 for event descriptions and the list above for the events that can be disabled.

6. Press Enter.
7. Press Cancel to return to the previous menu.

— or —

Press the Menu button to exit menu mode.

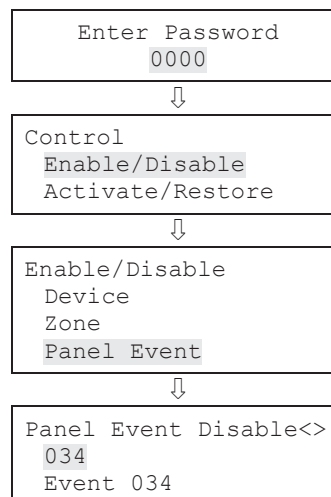

When you disable an event:

- The common Disable LED turns on.
- The common Trouble LED flashes and the panel goes into a trouble state.
- The common Trouble relay changes state.
- The disabled and active points indicators on the LCD increment.
- The LCD displays a message indicating that the event is disabled.

Disabling and enabling loop events

Disabling a loop event prevents it from being displayed, printed, or reported off premises. This is typically done during maintenance. For example, you might want to disable the Loop 1 unconfigured alarm event, if you are switching out a detector. Remember to reenable the event as soon as you have finished working.

When you disable a loop event:

- The common Disable LED turns on.
- The common Trouble LED flashes and the panel goes into a trouble state.
- The common Trouble relay changes state.
- The disabled and active points indicators on the LCD increment.
- The LCD displays a message indicating which loop event is disabled.

Not all events can be disabled. Those that cannot are labeled as “forbidden.” The following table lists events that can be disabled:

Table 42: Loop events that can be disabled

Event	ID
Loop 1 fault	001
Loop 2 fault	011
Loop 1 card fault	003
Loop 2 card fault	013
Loop 1 unconfigured alarm	004
Loop 2 unconfigured alarm	014
Loop 1 unconfigured trouble	005
Loop 2 unconfigured trouble	015

To disable or enable a loop event:

1. Press the menu button and choose Control.
2. Enter a level one password.
3. Choose Enable/Disable.
4. Choose Loop Event.
5. Select the loop event type that you want to disable or enable.
See “Event ID numbers and descriptions” on page 146 for event descriptions and the list above for the events that can be disabled.
6. Press Enter.
7. Press Cancel to return to the previous menu.
— or —
Press the Menu button to exit menu mode.

```
Control
Reports
Test
Control
Program
```



```
Enter Password
0000
```



```
Control
Enable/Disable
Activate/Restore
```



```
Enable/Disable
Zone
Panel Event
Loop Event
```



```
Loop Event  Disable<>
001
Event 001
```

— Or —

```
Loop Event  Enable<>
001
Event 001
```

Disabling and enabling panel NACs

Disabling a panel NAC prevents activations from being displayed, printed, or reported off premises. This is typically done during maintenance purposes. Remember to re-enable the NAC as soon as you have finished working.

NACs that have been disabled are not restored when the panel is reset. They must be enabled and then restored.

NACs configured as latched output devices are not restored when the panel is reset. They must be manually unlatched and then restored.

When you disable a panel NAC:

- The common Disable LED turns on.
- The LCD displays a message indicating that the NAC is disabled.
- The disabled and active points indicators on the LCD increment.
- The common Trouble LED flashes and the panel goes into a trouble state.
- The common Trouble relay changes state.

To disable or enable a panel NAC:

1. Press the menu button and choose Control.
2. Enter a level one password.
3. Choose Enable/Disable.
4. Choose Panel NAC.
5. Select the NAC that you want to disable or enable.
6. Press Enter.

The NAC is disabled and a message indicating that the NAC is disabled is displayed on the LCD.

7. Press Cancel to return to the previous menu.

— or —

Press the Menu button to exit menu mode.

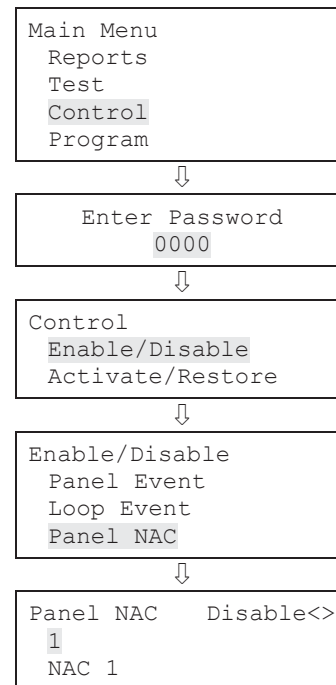

Disabling and enabling the dialer and network

Disabling the dialer, network CMS connection, or any panel or device NACs configured as City Tie prevents transmission of events to the central monitoring station (CMS).

When you enable the dialer and network CMS connection:

- The Remote Disconnect LED turns off.
- The message “Dialer Dsbl/Rem Disc” on the LCD disappears.
- The disabled points indicator on the LCD decrements.
- The active points indicator on the LCD decrements.

To disable or enable the dialer and network card:

1. Press Remote Disconnect.
2. Enter a level one password.

Initiating a fire drill

Pressing Drill activates all audible and visible notification appliances according to the panel programming, but does not activate the alarm relay. The Drill LED indicates the function is active.

Note: Drill will not operate with an active alarm or supervisory event at the panel.

To start and stop a drill:

1. To start a drill, press and hold the Drill button for two seconds.
The Drill button LED turns on indicating that the drill is active, and the control panel turns on all notification appliance circuits.
2. To stop the drill, press the Drill button again.
The Drill button LED turns off, and the control panel turns off all notification appliance circuits.

Note: The drill command is also available from the menu, under Control.

Conducting a walk test

A walk test lets you test individual zones or devices without having to create an actual alarm condition. You can conduct a walk test in silent or audible mode. In silent mode, the audible devices (NACs) do not sound.

Zones should be placed in walk test one at a time. This allows the balance of the system to remain in service. When a device is activated for test, it remains active throughout the test and does not restore until walk test is ended. When walk test is ended, all of the tested devices restore.

Note: Walk test will not operate with an active alarm or supervisory event at the panel.

When you enter walk test mode:

- The Test LED flashes for an audible walk test and is steady for a silent walk test.
- Walk Test is displayed on the LCD. Walk Test is replaced with the device activation message during the period the device is activated while in walk test.
- The panel enters a trouble state. There is no fire protection for the zone in walk test. If an unselected zone or device goes into alarm or trouble, all programmed outputs operate as programmed.

Zones and devices behave as follows during walk test:

- For alarm events, the appropriate panel and annunciator LEDs and buzzers turn on. In the audible (NAC) test mode a four-second pulse sounds for NAC types: continuous nonsilenceable, continuous silenceable, Genesis nonsilenceable, Genesis with audible silence only, and Genesis with audible and visible silenceable on the audible devices. A single 3-3-3 cycle sounds for NAC types: temporal nonsilenceable, temporal silenceable, coder basic, coder continuous, coder 120spm, and coder temporal on the audible devices.
- For trouble events, the appropriate LEDs and the buzzers turn on. In the audible (NAC) test mode a two-second pulse sounds on the audible devices.
- For ground fault events, the appropriate LEDs and the buzzers turn on. In the audible (NAC) test mode, a two-second pulse sounds on the audible devices.
- All device activations are latched until walk test is ended or the panel is reset. When walk test is ended, it takes approximately eight seconds for the devices to restore. If the device being tested is in a zone and does not restore, the zone does not reset.
- If auxiliary power is resettable, the auxiliary power is interrupted while the zone is reset.

- Input zones programmed as waterflow with retard require 10 to 15 seconds of activation to initiate the test signals.
- Devices programmed as alarm verify and *not in test mode* go directly into alarm if activated (the alarm verification process is bypassed).
- Once a device is tested, restore the device. For example, if you are testing a pull station, reset the pull station before testing the next device.

The panel terminates walk test if:

- The zone or device being tested remains inactive for 30 minutes
- Walk test is stopped by the user

To start a walk test:

1. Press the menu button and choose Test.
2. Choose Walk Test Silent or Walk Test Audible.
3. Enter a level one password.
4. Choose either All Devices or Zone.
5. If you chose Zone, enter the zone ID for the zone to be tested.
6. Choose Start.
7. Conduct the walk test.
8. Press Cancel to return to the previous menu.

— or —

Press the Menu button to exit menu mode.

Note: To see the activation and restoration of all walk test events, the panel must be reset *prior* to ending the walk test. Once the reset is complete, you can end the walk test and view a walk test report.

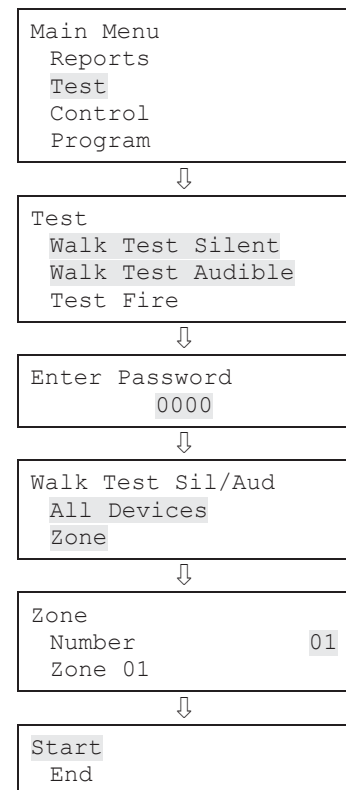

To end a walk test:

1. Press the menu button and choose Test.
2. Choose Walk Test Silent or Walk Test Audible.
3. Choose either All Devices or Zone.
4. If you chose Zone, enter the zone ID of the zone where you are ending the walk test.
5. Choose End to turn off the walk test. All of the devices

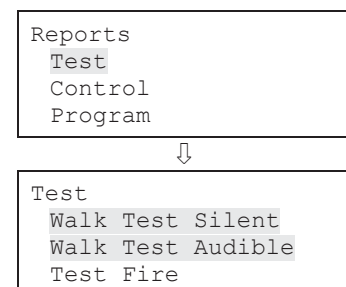

that were activated in the test are restored at this time.

6. Press Cancel to return to the previous menu.

— or —

Press the Menu button to exit menu mode.

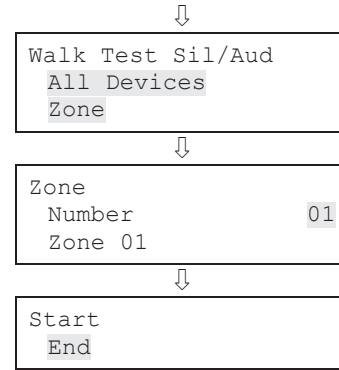

Chapter 4

Reports

Summary

This chapter describes how to create the panel's available reports.

Content

Basic steps for viewing and printing reports	168
History report	168
Walk Test report	170
Device Maintenance report	170
System Status report	171
Correlation Groups report	172
Correlation Group Configuration report	172
Zone report	173
System Configuration report	173
Internal Status report	174
Device Details report	175
Diagnostics reports	176
Internal Fault report	177
Canceling a report	178

Basic steps for viewing and printing reports

To view or print a report:

1. Press the menu button and choose Reports.
2. Select the report that you want to run.
3. Supply values for the options requested.
4. Choose either:
 - LCD: The report is displayed on the LCD.
 - or —
 - Printer:** The report is printed on the connected printer. If you do not have a printer, this option is not available.
5. If you selected LCD, press Cancel twice to return to the reports menu, when you have finished viewing the report.
6. Choose another report to view.
 - or —
 - Press the Menu button to exit menu mode.

Notes

- You must have a printer connected to the panel to print a report.
- Requesting a report while another report is being printed or displayed on the LCD stops the current report (even if it has not finished) and starts the new report that you requested.

History report

The panel maintains 1,000 system or user events. The event record contains the event time, the event type, the event state, and the device address (for device events). The event time is the time and date of the event activation or restoration. The event types are alarm, trouble, supervisory, monitor, and test activations or disable. The event state is either activation or restoration. The device address is the address for the device that caused the event. Some events do not have a device address listed, such as the type of events listed in the “Event ID numbers and descriptions” topic on page 146. These are “pseudo” type events. History reports can be viewed on the LCD or printed.

There are three types of history reports you can generate:

- All: Includes all events in the report
- Alarm: Includes only alarm events in the report
- Date forward: Lets you enter a starting date for the report. The report will include all events from that date forward.

To view an All or Alarm History report:

1. Press the menu button and choose Reports.
2. Choose History.
3. Choose either All or Alarm.

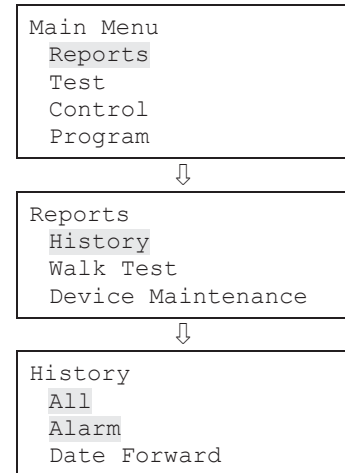

To view a Date Forward History report:

1. Press the menu button and choose Reports.
2. Choose History.
3. Choose Date Forward.
4. Enter the starting date for the report (month/day/year).

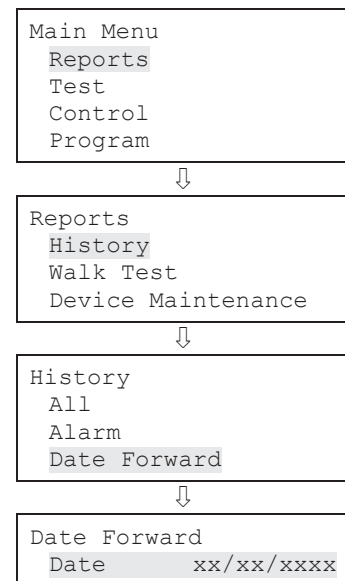

Walk Test report

The Walk Test report extracts all test events for the last walk test stored in history. Walk test reports can be printed or viewed on the LCD.

Notes

- You cannot view a walk test report while conducting a walk test.
- The walk test report includes all events (walk test and all other events) to show whether other events occurred during the walk test.
- The walk test report cannot be viewed from history after restarting the panel.
- To include the activation and restoration of all walk test events in the walk test report, the panel must be reset *prior* to ending the walk test. Once the reset is complete, you can end the walk test and view a walk test report.

To view a Walk Test report:

1. Press the menu button and choose Reports.
2. Choose Walk Test.

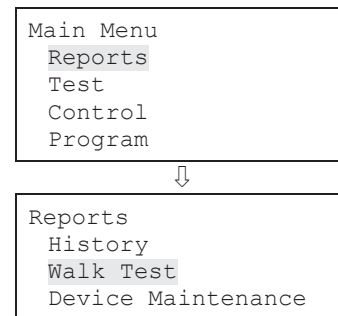

Device Maintenance report

The panel provides a Device Maintenance report of all detectors in the system. The report can include: all detectors, all detectors over 20% dirty, or all detectors over 80% dirty. The report displays the device, along with its dirty percentage and sensitivity setting. Device Maintenance reports can be printed or viewed on the LCD.

To view a Device Maintenance report:

1. Press the menu button and choose Reports.
2. Choose Device Maintenance.
3. Choose one of the following:
 - All Devices
 - Devices >= 20% Dirty
 - Devices >= 80% Dirty.

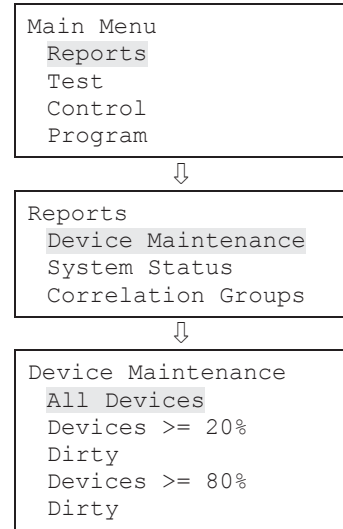

System Status report

The panel provides a System Status report for all active points in the system. The report can include: all active points, all alarm points, all supervisory points, all trouble points, all disabled points, or all other points. System status reports can be printed or viewed on the LCD.

To view a System Status report:

1. Press the menu button and choose Reports.
2. Choose System Status.
3. Choose one of the following:
 - All
 - Alarm
 - Supervisory
 - Trouble
 - Disable
 - Other

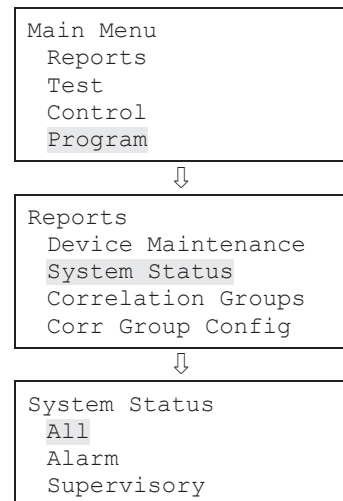

Correlation Groups report

The panel provides a report for each correlation group in the system. The Correlation Group report shows all of the devices, zones, and NACs that are assigned to a correlation group. Correlation group reports can be printed or viewed on the LCD.

To view a Correlation Groups report:

1. Press the menu button and choose Reports.
2. Choose Correlation Groups.
3. Enter the number of the correlation group for which you want a report.

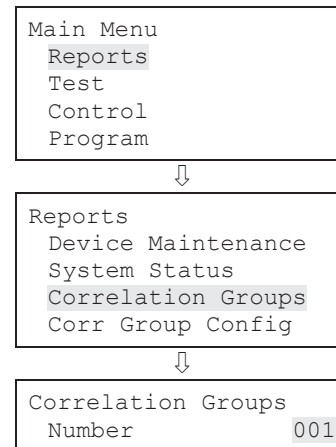

Correlation Group Configuration report

Correlation group configuration reports list:

- All correlation groups with in-suite signal silence enabled, or
- All correlation groups with an activation count greater than 1. This provides information on correlation groups programmed for special applications.

To view a Correlation Group Configuration report:

1. Press the menu button and choose Reports.
2. Choose Corr Group Config.
3. Choose one of the following:
 - Suite Sig Sil
 - ActivationCnt

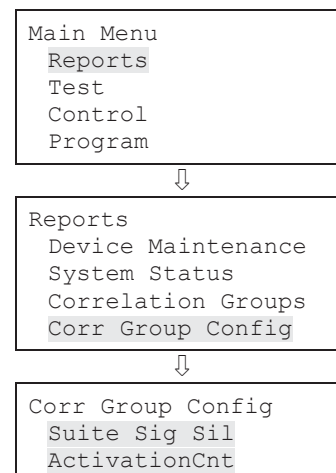

Zone report

The panel provides a Zone report that lists all of the devices that are in a selected zone. The report lists the devices by the device label.

To view a zone report:

1. Press the menu button and choose Reports.
2. Choose Zone.
3. Choose the zone for which you want a report.

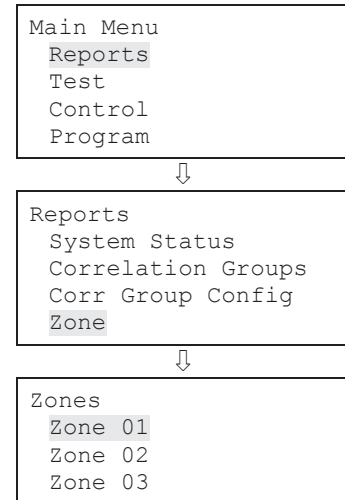

System Configuration report

The panel provides a System Configuration report that displays the current configuration of the system. There are seven system configuration reports displaying the information shown below. System configuration reports can be printed or viewed on the LCD.

All report: Displays all panel, device, loop, zone, event, and dialer configuration information.

Panel operation report: Displays firmware version, marketplace, language, AC fail delay, reset inhibit, zone re-sound, auto signal silence, in suite silence time, key #1, key #2, aux power reset, lock remote read, AC voltage, date format, daylight savings, minutes offset, day start, night start, mapping, LCD banner, IP (IP address), MSK (subnet mask), and GWY (gateway), and event notification type configuration information.

Panel configuration report: Displays dialer, network, printer, annunciator class, annunciator, and NAC configuration information.

Devices report: Displays function, type, zone, label, follow, day sensitivity, night sensitivity, day prealarm percent, night prealarm percent, correlation groups, and event notification configuration information.

Loop/zone configuration report: Displays loop class, zone, device, mapping, and correlation group configuration information.

Event configuration report: Displays loop event and panel event configuration information.

Dialer configuration report: Displays central monitoring station event notification settings for the points in the system.

To view a System Configuration report:

1. Press the menu button and choose Reports.
2. Choose System Configuration.
3. Choose:
 - All
 - Panel Operation
 - Panel Configuration
 - Loop/Zone Config
 - Devices
 - Event Config
 - Dialer Config.

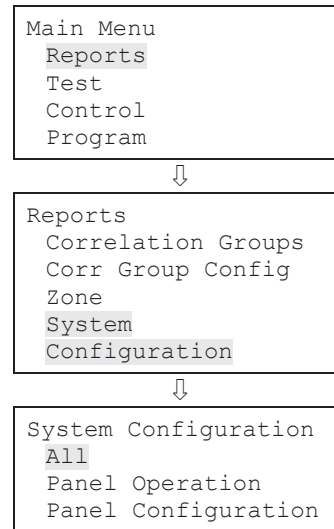

Internal Status report

The panel provides an Internal Status report that displays the current values for AC voltage, battery voltage, and battery charge current. Internal Status reports can be printed or viewed on the LCD.

To view an Internal System Status report:

1. Press the menu button and choose Reports.
2. Choose Internal Status.

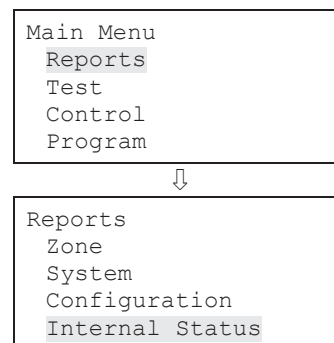

Device Details report

A Device Details report displays a device count that reports how many devices are connected to the system. The report can also display the serial number for each device connected to the system.

To view the device count on the system:

1. Press the menu button and choose Reports.
2. Choose Device Details.
3. Choose Device Count.

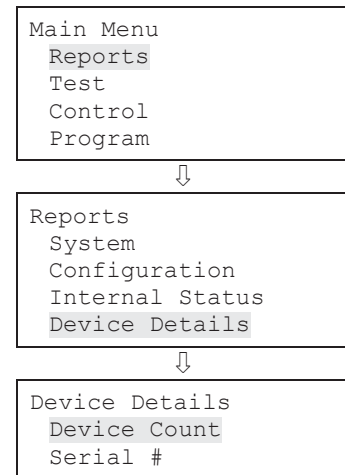

To view device serial numbers:

1. Press the menu button and choose Reports.
2. Choose Device Details.
3. Choose Serial #.

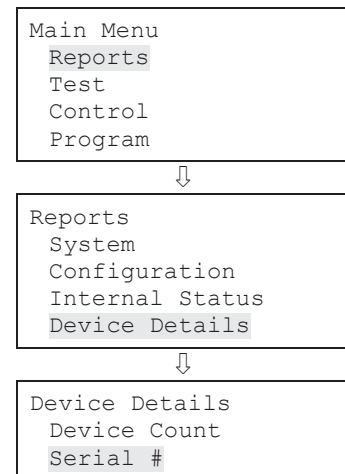

Diagnostics reports

There are two Diagnostics reports designed to show the communication performance of the devices on a loop.

Comm Retries report

This report lets you display a list of devices that have required two, three, or four consecutive communication poll retries. It lists the devices that could potentially generate a communication fault by showing the maximum number of retries for the current hour and a summary of the past 24 hours.

The report can be used to identify devices with intermittent communication faults. A device appearing in this report is an indication that the wiring to the device is suspect. To investigate problem devices, inspect the wiring between the problem device and another device not in the report. Inspect this section of wiring for problems such as loose connections and intermittent wiring breaks.

Note: The current hour retries can be cleared and updated by running the Loop Comm Check diagnostic. (See “Loop comm check” on page 183 for more information).

Response Quality report

This report lists the devices that are communicating at or below a quality percentage that you specify. By entering different percentages, you can troubleshoot device communications on a loop.

The panel periodically stores the measurement of the response for individual devices during communication polling. The report displays the result of the latest poll as a percentage, where 100% is the best response (maximum possible pulse strength) and anything less than 44% means that the device failed a communication poll and could potentially generate a communication fault.

Devices appearing in this report are an indication that the wiring to the devices is questionable or that the devices themselves are questionable. To investigate problem devices, inspect the wiring between the problem device and another device not in the report. Inspect the wiring for problems such as exceeding wiring specifications (see “Device loop wiring” on page 11 for more information), loose connections, and intermittent wiring breaks and shorts.

To view a Comm Retries diagnostic report:

1. Press the menu button and choose Reports.
2. Choose Diagnostics.
3. Choose Comm Retries.

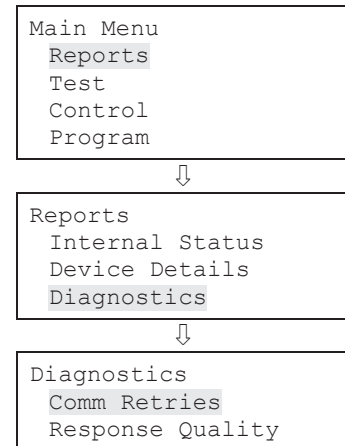
**To view a Response Quality diagnostic report:**

1. Press the menu button and choose Reports.
2. Choose Diagnostics.
3. Choose Response Quality.
4. Enter the quality percentage (0 to 100).

This is a communication percentage value that is used to display the device's minimum recorded pulse strength percentage. Enter "80" to list devices that are communicating up to 80 percent of their maximum pulse strength. Enter "50" to list devices that are communicating up to 50 percent of their maximum pulse strength (devices communicating better than 50% are not included in the report).

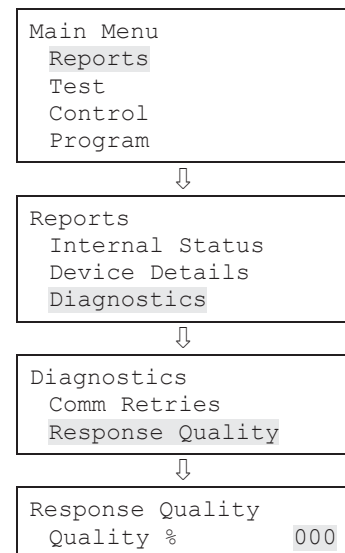

Internal Fault report

The Internal Fault report displays information about an internal fault event (event ID 48) that has occurred on the system. The report contains information for that is important for technical support when troubleshooting the internal fault event and should typically only be run when you are asked to do so by a technical support representative.

To view an Internal Fault report:

1. Press the menu button and choose Reports.
2. Choose Int. Fault.

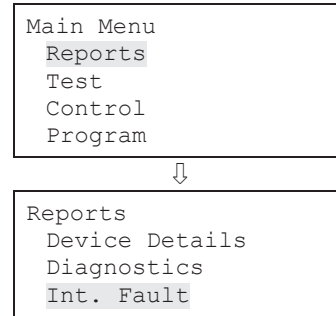

Canceling a report

Once a report is sent to the LCD or printer, you can cancel the report so that it stops printing on the printer or displaying on the LCD.

To cancel a report:

1. Press the menu button and choose Reports.
2. Choose Cancel Reports.
3. Choose Yes to cancel the report. Choose No to continue with the report.
4. Continue working with reports,
— or —

Press the Menu button to exit menu mode.

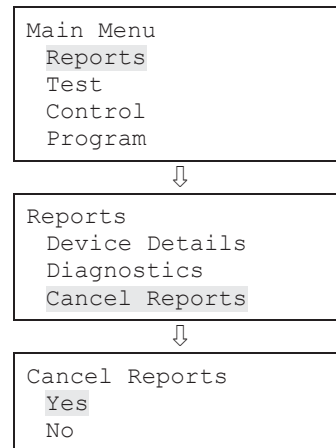

Chapter 5

Diagnostics, maintenance, and testing

Summary

This chapter provides diagnostics, preventive maintenance, and testing information.

Content

- Preventive maintenance schedule 180
- Fast ground check 180
- Recalibrate device 181
- Loop comm check 181
- Control panel testing 183
 - Canadian tests for grounds, opens, and shorts 183
- Testing a device (test fire) 184
- SA-DACT testing 184
- Conducting a lamp test 185
- Starting and stopping a walk test 186
- Using HyperTerminal 188
- Replacing a device in alarm 190

Preventive maintenance schedule

Refer to NFPA 72 section Inspection, Testing, and Maintenance, Canadian Electrical Code Part I, ULCS524, or ULCS536 for more information on required inspection and testing methods and frequency of fire alarm systems and devices. For detector sensitivity and functionality testing, refer to the detector manufacturer's installation instructions.

Fast ground check

Fast Ground Check is used to quickly check the system for ground faults. Every 30 seconds, the system checks for ground faults and reports them by flashing the Ground Fault LED. If you are troubleshooting ground faults on the system, you may not want to wait 30 seconds for the ground fault to clear. If the ground fault was not fixed, you may not want the LED to stay active. By using Fast Ground Check, you can decrease the system check time to every 4 seconds, meaning that you will be able to troubleshoot your ground faults much quicker and determine if they have been fixed or not.

Note: Once you solve the ground faults on the system, turn off the Fast Ground Check.

To turn on and off Fast Ground Check:

1. Press the menu button and choose Diagnostics.
2. Enter a level two password.
3. Choose Fast Ground Check.
4. Choose Start to turn on Fast Ground Check or choose End to turn off Fast Ground Check.

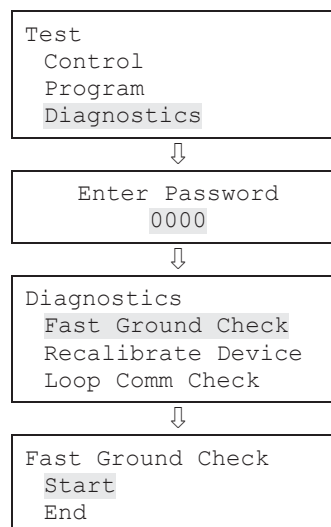

Recalibrate device

The Recalibrate command resets a detector's environmental compensation and dirtiness level. You can use this command after cleaning to see immediately whether the device was cleaned properly. Allowing the panel to recognize that the device has been cleaned and recalibrate it automatically takes considerably more time. A device trouble will return, indicating that more cleaning is required. If the device is cleaned, the corresponding device trouble will clear.

To recalibrate a device:

1. Press the menu button and choose Diagnostics.
2. Enter a level two password.
3. Choose Recalibrate Device.
4. Choose the loop the device is on.

Note: If the panel only has one loop, the loop selection screen does not display. Go to the next step.
5. Choose the number of the device that you want to recalibrate.
6. Press Enter.

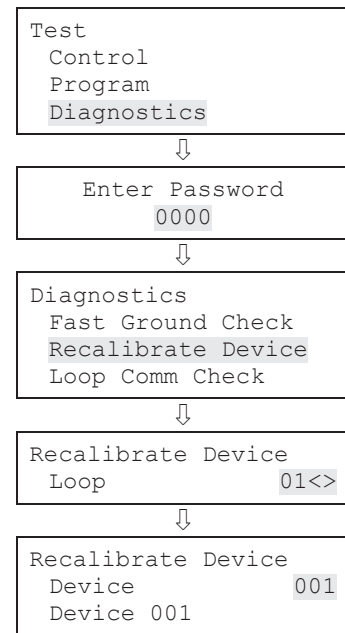

Loop comm check

Loop Comm Check is used to determine which loop devices are not communicating. When you run this command, the system checks the device communications on the system's device loops. The devices that are not communicating are listed in a report that you can then use to troubleshoot the problem. Once a report is generated, it remains in memory until another report is generated. This lets you access the latest report in Reports menu > Diagnostics > Loop Comm Check.

To do a loop comm check:

1. Press the menu button and choose Diagnostics.
2. Enter a level two password.
3. Choose Loop Comm Check.

You can monitor the progress of the check on the Diagnostics screen.

4. Once the check is complete, choose “Continue” to go to the report Diagnostics screen, then continue with the next step.

— or —

Choose “Back” to return to the Diagnostics menu. If you choose Back, you have to go to the Reports menu > Diagnostics > Loop Comm Check to see the report once the report is created.

Note: This process may take considerable time depending on how large the system is. If it takes longer than four minutes (login time expiration), the system automatically logs you out if there isn’t any activity. If this occurs, you must log back in and go to the Reports section to view the diagnostic report once it is generated.

5. Choose Loop Comm Check.
6. Choose either:

LCD: This displays the report on the LCD.

— or —

Printer: The sends the report the printer (if one is connected to the panel). If you do not have a printer, this option is not available.

7. If you selected LCD, press Cancel twice to return to the reports menu, when you have finished viewing the report.
8. Press the Menu button to exit menu mode.

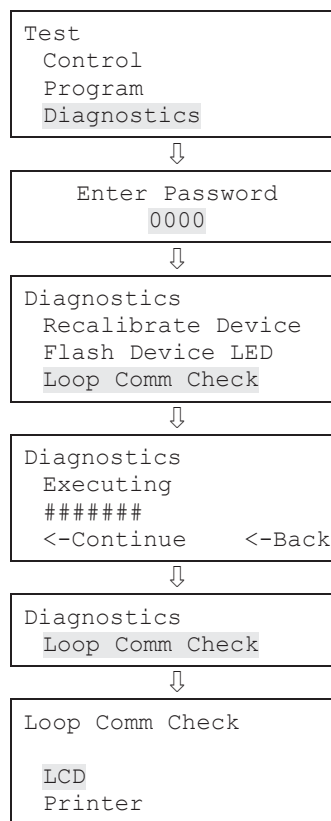

Control panel testing

Before starting, notify all areas where the alarm sounds and off-premises locations that receive alarm and trouble transmissions that testing is in progress.

Records of all testing and maintenance shall be kept as required by the authority having jurisdiction.

- Required tools:
 - Slotted screwdriver, insulated
 - Digital multimeter
 - 12 in. (30.5 cm) jumper lead with alligator clips
 - Panel door key
 - Sound level meter
- A complete check of installed field wiring and devices should be made at regular intervals in accordance with NFPA 72, Canadian Electrical Code Part I, ULC S524, and ULC S536 requirements. This includes testing all alarm and supervisory initiating devices and circuits and any off-premises connections.
- Panel operation should be verified in the alarm, supervisory, and trouble modes.
- To ensure that the panel can operate correctly when primary power is lost, the batteries should be inspected and tested periodically. Batteries should be replaced (at a minimum) every four years.

Canadian tests for grounds, opens, and shorts

ULC requires that you test ground fault, open circuit, and short circuit indications.

For ground fault tests, short one leg of the circuit to chassis ground and verify that the system Ground Fault LED and Trouble LEDs turn on.

For NAC open circuit tests, remove the end-of-line resistor from the last device on the circuit and verify that the system Trouble LED turns on.

For NAC short circuit testing, place a short across the NAC output terminals and verify that the system Trouble LED turns on.

For AUX power short circuit testing, place a short across the AUX power output's plus (+) and minus (–) terminals and verify that the system Trouble LED turns on.

For annunciator communications testing, place a short across channel 1 (+ and –) and verify that the system Trouble LED turns on. Repeat for channel 2.

Testing a device (test fire)

A test fire is a test activation of a smoke or heat detector or input module. A test fire can be conducted to test for proper operation of a detector or input module and its programming. When a detector is test fired, the panel sends a command to the detector at which time the detector simulates a smoke or heat buildup, causing an actual activation of the detector. When an input module is test fired, the panel sends a command to the module causing the module to simulate an activation (alarm, supervisory, or monitor).

Note: NAC responses activate as programmed.

To test fire a device:

1. Press the menu button and choose Test.
2. Choose Test Fire.
3. Enter a level one password.
4. Choose the loop the device is on.

Note: If the panel only has one loop, the loop selection screen does not display. Go to the next step.
5. Enter the device number of the device you want to test fire.
6. Press Enter.
7. Choose Start to start the test.
8. When you have finished, press Reset (or repeat steps 1 to 7 and choose End) to clear the test alarms and return the system to normal.
9. Press Cancel to return to the previous menu.

— or —

Press the Menu button to exit menu mode.

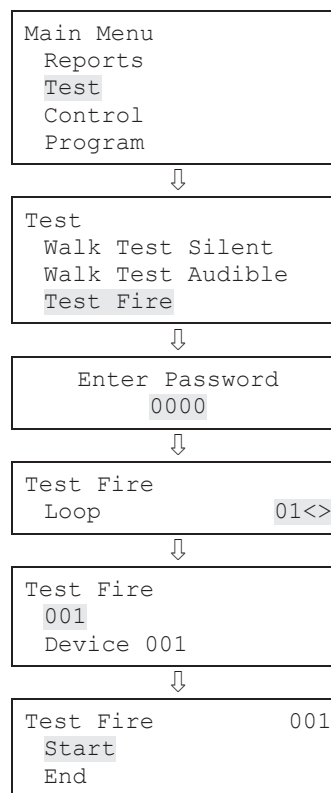

SA-DACT testing

A dialer test is a test of the telephone line for each dialer account. When a dialer is tested, a normal or abnormal test message (depending on the state of the system) is sent to the selected account. If the dialer is set up for dual line operation, a test

message is sent to both lines regardless of the success of the transmission for either account.

Note: Before conducting a test, configure the dialer’s accounts for proper operation.

To conduct a dialer test:

1. Press the control panel’s Menu button.
2. Choose Test.
3. Choose Dialer.
4. Enter a level one password.
5. Select the account that you want to test.
6. Press Enter.

Note: The test message is sent to the CMS account that you selected. For verification of the CMS account receiving the test message, you must be in contact with the CMS account during the test. Nothing is displayed on the LCD.

7. Press Cancel to return to the previous menu.

— or —

Press the Menu button to exit menu mode.

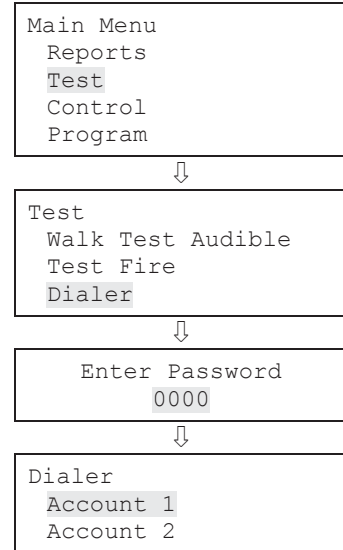

Conducting a lamp test

A lamp test lights all of the LEDs on the panel and the LED annunciator and tests the LCD so that you can verify proper operation. LEDs stay on for 15 seconds.

To conduct a lamp test:

1. Press the menu button and choose Test.
2. Choose Lamp Test.
3. Press Enter.
4. Verify that all LEDs on the panel, the LCD, and the LED annunciator (if used) work properly.

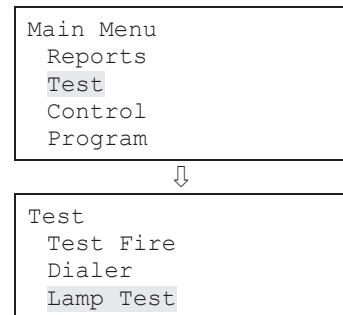

Starting and stopping a walk test

A walk test lets you test individual zones or devices without having to create an actual alarm condition. You can conduct a walk test in silent or audible mode. In silent mode, the audible devices (NACs) do not sound.

Zones should be placed in walk test one at a time. This allows the balance of the system to remain in service. When a device is activated for test, it remains active throughout the test and does not restore until walk test is ended. When walk test is ended, all of the tested devices restore.

Note: Walk test will not operate with an active alarm or supervisory event at the panel.

When you enter walk test mode:

- The Test LED flashes for an audible walk test and is steady for a silent walk test.
- Walk Test is displayed on the LCD. Walk Test is replaced with the device activation message during the period the device is activated while in walk test.
- The panel enters a trouble state. There is no fire protection for the zone in walk test. If an unselected zone or device goes into alarm or trouble, all programmed outputs operate as programmed.

Zones and devices behave as follows during walk test.

- For alarm events, the appropriate panel and annunciator LEDs and buzzers turn on. In the audible (NAC) test mode a four-second pulse sounds for NAC types: continuous nonsilenceable, continuous silenceable, Genesis nonsilenceable, Genesis with audible silence only, and Genesis with audible and visible silenceable on the audible devices. A single 3-3-3 cycle sounds for NAC types: temporal nonsilenceable, temporal silenceable, coder basic, coder continuous, coder 120spm, and coder temporal on the audible devices.
- For trouble events, the appropriate LEDs and the buzzers turn on. In the audible (NAC) test mode a two-second pulse sounds on the audible devices.
- For ground fault events, the appropriate LEDs and the buzzers turn on. In the audible (NAC) test mode, a two-second pulse sounds on the audible devices.
- All device activations are latched until walk test is ended or the panel is reset. When walk test is ended, it takes approximately eight seconds for the devices to restore. If the device being tested is in a zone and does not restore, the zone does not reset.
- If auxiliary power is resettable, the auxiliary power is interrupted while the zone is reset.

- Input zones programmed as waterflow with retard require 10 to 15 seconds of activation to initiate the test signals.
- Devices programmed as alarm verify and *not in test mode* go directly into alarm if activated (the alarm verification process is bypassed).
- Restore each device after testing. For example, if you are testing a pull station, reset the pull station before testing the next device.

The panel terminates walk test if:

- The zone or device being tested remains inactive for 30 minutes.
- Walk test is stopped by the user.

To start a walk test:

1. Press the menu button and choose Test.
2. Choose Walk Test Silent or Walk Test Audible.
3. Enter a level one password.
4. Choose either All Devices or Zone.
5. If you chose Zone, enter the zone ID for the zone you are going to conduct the walk test.
6. Choose Start.
7. Conduct your walk test.
8. Press Cancel to return to the previous menu.

— or —

Press the Menu button to exit menu mode.

Note: To see the activation and restoration of all walk test events, the panel must be reset *prior* to ending the walk test. Once the reset is complete, you can end the walk test and view a walk test report.

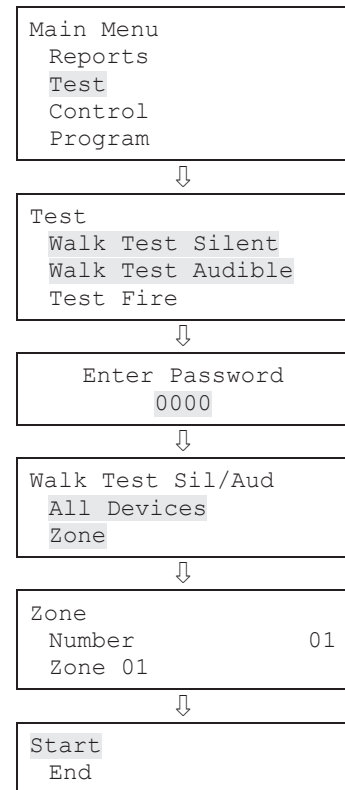

To end a walk test:

1. Press the menu button and choose Test.
 2. Choose Walk Test Silent or Walk Test Audible.
 3. Choose either All Devices or Zone.
 4. If you chose Zone, enter the zone ID of the zone for which you are going to end the walk test.
 5. Choose End to turn off the walk test. All of the devices that were activated in the test are restored at this time.
 6. Press Cancel to return to the previous menu.
- or —
- Press the Menu button to exit menu mode.

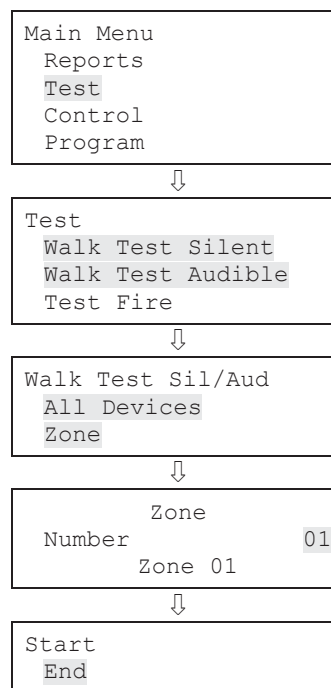

Using HyperTerminal

Note: To use HyperTerminal, you must have the optional SA-232 RS-232 Interface Card installed in the control panel. To avoid getting a printer trouble, set the panel's printer option to Unsupervised before connecting your computer to the SA-232 card.

HyperTerminal is a useful tool for gathering information from the control panel through an RS-232 port connection in order to troubleshoot system faults. The information gathered can be saved as a plain text file (TXT extension) and submitted electronically to technical support for evaluation.

HyperTerminal comes with your Windows operating system as an installable option. HyperTerminal, if installed, is typically found on the Accessories menu (Start > All Programs > Accessories > Communications).

Setting up a HyperTerminal connection

Before you can gather information from the control panel you must set up a HyperTerminal connection.

To set up a HyperTerminal connection:

1. Start HyperTerminal.
2. In the Connection Description dialog box, type a name for the connection in the Name box then click OK.
3. In the Connect To dialog box, select the COM port you are using to connect your laptop computer to the control panel then click OK.
4. In the COM port's Properties dialog box, set the port settings as described below then click OK.

Bits per second: 9600

Data bits: 8

Parity: None

Stop bits: 1

Flow control: None

5. On the File menu, click Save to save your connection settings.

Capturing a report

The history report provides useful information for troubleshooting system faults. You should always have this information available before calling technical support.

To capture a report:

1. On the Transfer menu, click Capture Text.
2. In the File box in the Capture Text dialog box, type a name for the captured text file. Example: History Report. The TXT file extension is added automatically.
If you want to save the file somewhere other than the default location, click the Browse button, navigate to the desired location, then name the file.
3. Click Start.
4. On the front panel, go to the main menu, choose Reports, then choose the report you want captured.
5. On the Print Output menu, choose Printer to send the report to HyperTerminal.
6. Wait until the report transfer is complete.
7. On the Transfer menu, click Capture Text, and then Stop.

Replacing a device in alarm

You can replace a device with a new device of the same type while it is in alarm. You may need to do this because the device is faulty or for other troubleshooting reasons. If you replace a device while it is in alarm, the device and control panel operate as follows:

- When the device in alarm is removed, the control panel remains in alarm and a trouble event is displayed.
- The new device does not go into alarm when it is installed, but the LCD displays a second trouble event when the new device is detected by the panel.
- When the control panel resolves the new device, the alarm condition restores and the two trouble events clear on the control panel.

Note: If the device causing the alarm is reinstalled, the device goes back into alarm and the alarm condition does not restore.

Appendix A

Panel specifications

Summary

This appendix lists all of the specifications for the control panel.

Content

Control panel specifications 192

Control panel specifications

	VS1 panel	VS2 panel
Device loops	1 loop Class B or Class A (Styles 4, 6, 7) supporting up to 64 device addresses (any combination of detectors and modules) Maximum T-taps: 63 (each device can be on its own branch)	1 loop, expandable to 2, Class A or B (Styles 4, 6, 7), each loop supporting up to 250 device addresses (125 detectors and 125 modules max.). Note: Addresses 1 to 125 are for detectors and addresses 126 to 250 are for modules. Maximum T-taps: 124
Notification appliance circuits	2 Class B (Style Y), Class A (Style Z) optional 3.75 A FWR total at 120/230 VAC 60 Hz 3.0 A FWR total at 230 VAC 50 Hz 2.5 A FWR each max. per circuit	4 Class B (Style Y) or 2 Class A (Style Z) 6.0 A FWR total at 120/230 VAC 60 Hz 5.0 A FWR total at 230 VAC 50 Hz 2.5 A FWR each max. per circuit
Primary power	120 VAC, 60 Hz, 1.3 A max. 230 VAC, 50-60 Hz, 0.6 A max.	120 VAC, 60 Hz, 1.8 A max. 230 VAC, 50-60 Hz, 0.975 A max.
Base panel current standby	155 mA	172 mA
Base panel current alarm	204 mA	267 mA
Input zones	16 max.	32 max.
Remote annunciator	8 drops max., RS-485 Class B, Class A optional Data line length: 4,000 ft. (1,219 m)	8 drops max., RS-485 Class A or B Data line length: 4,000 ft. (1,219 m)
Operating voltage	24 VDC	
Auxiliary power output circuit	Aux power 1: 500 mA, 24 VDC Aux power 2: 500 mA, 24 VDC (1 A possible if you reduce total available NAC power by 500 mA) Output: 28.3 to 21.9 VDC, special application Note: For a complete list of devices that can be connected to this circuit, see the <i>Vigilant VS1 and VS2 Series Compatibility List</i> (P/N 3101065).	

	VS1 panel	VS2 panel
Loop circuit	<p>Maximum loop resistance: 66 Ω Maximum loop capacitance: 0.7 μF Communication line voltage: Maximum 20.6 V peak-to-peak Operating current (fully loaded loop) Stand by: 60 mA Alarm: 125 mA (this does not include two-wire smoke modules) Circuit current: 0.5 A max. Style 4, 6, and 7 wiring Max. resistance between isolators: Limited only by overall wire run lengths 64 isolators maximum (total both isolator bases and modules)</p>	
Batteries	<p>Type: Sealed lead acid Voltage: 24 VDC Charging current: 2.47 A max. Amp hour capacity: 26 Ah Standby operation: 24 hour or 60 hour Placement: Up to two 10 Ah batteries will fit in the Vigilant VS1 control panel cabinet and two 18 Ah batteries will fit in the VS2 control panel cabinet. If larger batteries are required, you must use a GE Security battery cabinet.</p>	
SA-DACT dialer	<p>Phone line type: One or two loop-start lines on a public, switched network Phone line connector: RJ-31/38X (C31/38X) Communication formats: Contact ID (SIA DC-05) Operating current Standby/Alarm: 41 mA Max.: 100 mA FCC registration number: GESAL01BSADACT Industry Canada Registration number: 3944A-SADACT Ringer equivalence number: 0.1B</p>	
Ground fault impedance	0 to 5 k Ω	
Alarm contact	Form C N.O. 24 VDC at 1 A (resistive load)	
Trouble contact	Form C 24 VDC at 1 A (resistive load)	
Supervisory contact	Form A N.O. 24 VDC at 1 A (resistive load)	
Environmental	<p>Temperature: 0 to 49°C (32 to 120°F) Humidity: 0 to 93% RH, noncondensing</p>	
Terminal rating	All terminals rated for 12 to 18 AWG (0.75 to 2.5 sq. mm)	

Appendix B

Worksheets

Summary

This appendix contains all of the worksheets needed to program the panel, calculate NAC requirements and battery requirements.

Content

Battery calculation worksheet	196
Notification appliance circuit calculations worksheet	199
Introduction	199
What you'll need	199
Worksheet method	201
Equation method	202
Notification appliance voltage drop calculation worksheet	205
Device loop maximum wire length worksheet	206
Correlation groups worksheet	212
Device settings worksheet	213
Loop worksheet	215
Panel configuration worksheet	216
Panel operation worksheet	219
Zone settings worksheet	220

Battery calculation worksheet

Use this worksheet to determine the minimum amp hour capacity required for the panel's standby battery. You can obtain operating current requirements for notification appliances from their respective installation sheets.

Battery calculation worksheet

	Standby current (mA)	Alarm current (mA)	
Control panel (use Worksheet A and place totals here)	<input style="width: 100%; height: 30px;" type="text"/>	<input style="width: 100%; height: 30px;" type="text"/>	
Auxiliary/smoke power (use Worksheet B and place totals here)	<input style="width: 100%; height: 30px;" type="text"/>	<input style="width: 100%; height: 30px;" type="text"/>	
NAC 1	<input style="width: 100%; height: 30px;" type="text"/>	<input style="width: 100%; height: 30px;" type="text"/>	
NAC 2	<input style="width: 100%; height: 30px;" type="text"/>	<input style="width: 100%; height: 30px;" type="text"/>	
NAC 3	<input style="width: 100%; height: 30px;" type="text"/>	<input style="width: 100%; height: 30px;" type="text"/>	
NAC 4	<input style="width: 100%; height: 30px;" type="text"/>	<input style="width: 100%; height: 30px;" type="text"/>	
Total current	<input style="width: 100%; height: 30px;" type="text"/>	<input style="width: 100%; height: 30px;" type="text"/>	
Operating time required	× <input style="width: 50px;" type="text"/> hr	× <input style="width: 50px;" type="text"/> min	
	<hr style="width: 100%;"/>	<input style="width: 100%; height: 30px;" type="text"/>	
		<hr style="width: 100%;"/>	
	<input style="width: 100%; height: 30px;" type="text"/>	+ <input style="width: 100%; height: 30px;" type="text"/>	= <input style="width: 100%; height: 30px;" type="text"/> mAh
			<hr style="width: 100%;"/>
			× 1.2
			<input style="width: 100%; height: 30px;" type="text"/> mAh
			<hr style="width: 100%;"/>
			÷ 1,000
			<hr style="width: 100%;"/>
Battery size [1]			<input style="width: 100%; height: 30px;" type="text"/> Ah

[1] Battery size may not exceed 26 Ah for UL/ULC systems. See Appendix A "Panel specifications" on page 191 and "Battery wiring (TB8)" on page 7 for battery details.

Worksheet A: Control panel current load

Devices	Qty	Standby current (mA)	Alarm current (mA)	Qty x Standby current (mA)	Qty x Alarm current (mA)
Base panel	1	See note [1] below	See note [2] below		
Primary loop circuit (fully loaded loop)		55	125		
V-SLC loop expander card (fully loaded loop)		60	125		
SA-CLA Class A card		3	60		
SA-232 RS-232 card		13	13		
SA-DACT dialer		41	41		
SA-ETH network card		34	34		
LED expander		4	1 expander: 48 2 expanders: 96		
Totals (mA) (transfer totals to Battery Calculation Worksheet)					

[1] VS1: 155
VS2: 172

[2] VS1: 204
VS2: 267

Worksheet B: Auxiliary/smoke power current load

Devices	Qty	Standby current (mA)	Alarm current (mA)	Qty x Standby current (mA)	Qty x Alarm current (mA)
RPM	<input type="text"/>	20	270	<input type="text"/>	<input type="text"/>
GSA-UM or -MAB [1]	<input type="text"/>	17	58	<input type="text"/>	<input type="text"/>
RLCD(F)	<input type="text"/>	98	113	<input type="text"/>	<input type="text"/>
RLCD-C(F)	<input type="text"/>	99	115	<input type="text"/>	<input type="text"/>
RLED-C(F)	<input type="text"/>	28	62	<input type="text"/>	<input type="text"/>
LED24	<input type="text"/>	6	34	<input type="text"/>	<input type="text"/>
	<input type="text"/>			<input type="text"/>	<input type="text"/>
	<input type="text"/>			<input type="text"/>	<input type="text"/>
	<input type="text"/>			<input type="text"/>	<input type="text"/>
	<input type="text"/>			<input type="text"/>	<input type="text"/>
	<input type="text"/>			<input type="text"/>	<input type="text"/>
	<input type="text"/>			<input type="text"/>	<input type="text"/>
	<input type="text"/>			<input type="text"/>	<input type="text"/>
Totals (mA) (transfer totals to Battery Calculation Worksheet)				<input type="text"/>	<input type="text"/>

[1] Enter 1 regardless of how many are installed. Only the first GSA-UM or -MAB in the alarm state draws current. The other ones do not because the system load sheds additional modules in alarm.

Notification appliance circuit calculations worksheet

Introduction

This topic shows you how to determine the maximum cable length of a notification appliance circuit (NAC) for a given number of appliances.

Two methods are presented: worksheet and equation. The worksheet method is simpler, but your installation must meet the criteria listed on the worksheet. If your installation does not meet these criteria, you need to use the equation method.

The methods given here determine cable lengths that work under all operating conditions. The calculations ensure that the required operating voltage and current will be supplied to all notification appliances. To do this, we assume these two worst-case conditions:

- The voltage at the NAC terminals is the minimum provided by the power supply
- The notification appliances are clustered at the end of the NAC cable

Other, more detailed methods that distribute the appliance load along the NAC cable may indicate that longer cable runs are possible.

What you'll need

Appliance and cable values

Whether you use the worksheet method or the equation method, you'll need to know:

- The minimum operating voltage required for the appliances
- The maximum operating current drawn by each appliance
- The resistance per unit length of the wire used ($\Omega/\text{ft.}$)

This information can be found on the appliance installation sheets and on the cable specification sheet.

Power supply values

For either method, you'll need some fixed or calculated operating values for your specific power supply. The fixed values are:

- Source voltage = 20.4 V
- Load factor for VS1 panel = 0.20 V/A
- Load factor for VS2 panel = 0.24 V/A
- Power type = FWR

The *source voltage* is the theoretical operating minimum for the power supply, and is calculated as 85% of 24 volts.

The *load factor* is a measure of how the power supply voltage reacts when a load is applied. The load factor measures the voltage drop per ampere of current drawn by the load.

The *power type* reflects the type of power supplied to the NAC terminals at minimum voltage. The current draw of notification appliances can vary substantially with the type of power supplied: full-wave rectified (VFWR) or direct current (VDC). It is important to know the power type at minimum terminal voltage.

You'll need to calculate the following values relating to your power supply and to the NAC circuit current. These are:

- Minimum voltage
- Voltage drop

The *minimum voltage* is the lowest voltage measured at the NAC terminals when the power supply is under the maximum load for that circuit (i.e. for the appliances that constitute the NAC.)

The *voltage drop* is the difference between the minimum voltage and 16 V. This value is for use with the worksheet only.

Worksheet method

Use this worksheet to determine the maximum cable length of a notification appliance circuit for a given number of appliances.

Use this worksheet only if all the appliances are regulated. That is, they must have a minimum operating voltage of 16 V. For other appliances, use the “Equation method.”

NAC cable length

		NAC1	NAC2	NAC3	NAC4	
Total operating current [1]		<input type="text"/>	<input type="text"/>	<input type="text"/>	<input type="text"/>	A
Load factor (VS1 panel)	×	<input type="text" value="0.20"/>	<input type="text" value="0.20"/>	<input type="text" value="0.20"/>	<input type="text" value="0.20"/>	V/A
Load factor (VS2 panel)		<input type="text" value="0.24"/>	<input type="text" value="0.24"/>	<input type="text" value="0.24"/>	<input type="text" value="0.24"/>	
Load voltage drop	=	<input type="text"/>	<input type="text"/>	<input type="text"/>	<input type="text"/>	V
Source voltage		<input type="text" value="20.4"/>	<input type="text" value="20.4"/>	<input type="text" value="20.4"/>	<input type="text" value="20.4"/>	V
Load voltage drop	–	<input type="text"/>	<input type="text"/>	<input type="text"/>	<input type="text"/>	V
Minimum voltage	=	<input type="text"/>	<input type="text"/>	<input type="text"/>	<input type="text"/>	V
Regulated appliance voltage	–	<input type="text" value="16.0"/>	<input type="text" value="16.0"/>	<input type="text" value="16.0"/>	<input type="text" value="16.0"/>	V
Voltage drop [2]	=	<input type="text"/>	<input type="text"/>	<input type="text"/>	<input type="text"/>	V
Total operating current	÷	<input type="text"/>	<input type="text"/>	<input type="text"/>	<input type="text"/>	A
Maximum resistance	=	<input type="text"/>	<input type="text"/>	<input type="text"/>	<input type="text"/>	Ω
Wire resistance (Ω/ft) [3]	÷	<input type="text"/>	<input type="text"/>	<input type="text"/>	<input type="text"/>	
Maximum wire length	=	<input type="text"/>	<input type="text"/>	<input type="text"/>	<input type="text"/>	ft.
	÷	<input type="text" value="2"/>	<input type="text" value="2"/>	<input type="text" value="2"/>	<input type="text" value="2"/>	
Maximum cable length	=	<input type="text"/>	<input type="text"/>	<input type="text"/>	<input type="text"/>	ft.

[1] Total of the maximum operating currents for all appliances as specified for FWR power. See the appliance installation sheets for operating currents.

[2] This voltage drop is valid for regulated notification appliances only. For unregulated appliances, see “Equation method” on page 202.

[3] Use the manufacturer’s published wire resistance expressed in ohms per foot. For typical values, see Table 43 on page 202.

Equation method

Appliance operating voltage and current

Regulated notification appliances have an operating range from 16 V to 33 V. Use 16 V as the minimum appliance voltage when using regulated notification appliances.

When using special application notification appliances, refer to the installation sheets to determine the minimum appliance voltage required.

What if there are different types of appliances in the NAC, and each type has a different minimum operating voltage? In this case, use the *highest* minimum voltage required by any appliance.

The total current requirement for the appliances will be the sum of the individual maximum currents drawn by each appliance when using FWR power. Use the maximum current for the appliance over the 16 V to 33 V range.

If all appliances draw the same maximum current, the total current is the maximum current multiplied by the number of appliances. If different appliance types have different maximum currents, the total current is the sum of the maximum current for each appliance type multiplied by the number of appliances of that type.

Wire resistance

Typical wire resistances are shown in the following table.

Table 43: Typical wire resistances

Wire gauge	Resistance 1-strand uncoated copper		Resistance 7-strand uncoated copper	
	Ω per foot	Ω per meter	Ω per foot	Ω per meter
12 AWG	0.00193	0.00633	0.00198	0.00649
14 AWG	0.00307	0.01007	0.00314	0.01030
16 AWG	0.00489	0.01604	0.00499	0.01637
18 AWG	0.00777	0.02549	0.00795	0.02608

When performing these calculations, always refer to the actual cable supplier documentation and use the actual Ω/ft. (or Ω/m) for the cable being used.

Calculating cable length

To calculate the maximum NAC cable length:

1. Calculate the total current (I_{tot}) as the sum of the maximum operating currents for all the appliances.

$$I_{tot} = \sum I_a$$

Where:

I_a = appliance maximum current

Refer to the appliance installation sheets for I_a . Remember to use the maximum operating current specified for FWR power.

2. Calculate the minimum voltage (V_m).

$$V_m = V_s - (I_{tot} \times K)$$

Where:

V_s = source voltage

I_{tot} = total current (from above)

K = load factor

VS1 panel: For the power supply, V_s is 20.4 V and K is 0.20 V/A.

VS2 panel: For the power supply, V_s is 20.4 V and K is 0.24 V/A

3. Calculate the allowable voltage drop (V_d) between the power supply and the appliances.

$$V_d = V_m - V_a$$

Where:

V_m = minimum voltage (from above)

V_a = appliance minimum voltage

For regulated notification appliances, V_a is 16 V. For special application notification appliances, V_a is the lowest operating voltage specified on the appliance installation sheet.

4. Calculate the maximum resistance (R_{max}) for the wire.

$$R_{max} = V_d / I_{tot}$$

Where:

V_d = voltage drop

I_{tot} = total current

5. Calculate the maximum length of the cable (L_c), based on the maximum resistance allowed, the resistance of the wire, and the number of wires in the cable (two).

$$L_c = (R_{max} / R_w) / 2$$

Where:

R_{max} = maximum resistance

R_w = wire resistance factor

Example: You're using regulated notification appliances. Assume that the maximum operating current for each appliance is 100 mA for FWR power, and that 20

appliances will be placed on the NAC. The cable is 12 AWG wire, and the manufacturer specifies a wire resistance factor of 0.002 Ω/ft.

$$\begin{aligned}
 I_{\text{tot}} &= \Sigma I_a \\
 &= 20 \times 0.1 \text{ A} \\
 &= 2 \text{ A}
 \end{aligned}$$

$$\begin{aligned}
 V_m &= V_r - (I_{\text{tot}} \times K) \\
 &= 20.4 \text{ V} - (2 \text{ A} \times 0.20 \text{ V/A}) \\
 &= 20.4 \text{ V} - 0.40 \text{ V} \\
 &= 20.0 \text{ V}
 \end{aligned}$$

$$\begin{aligned}
 V_d &= V_m - V_a \\
 &= 20.0 \text{ V} - 16.0 \text{ V} \\
 &= 4.0 \text{ V}
 \end{aligned}$$

$$\begin{aligned}
 R_{\text{max}} &= V_d / I_{\text{tot}} \\
 &= 4.0 \text{ V} / 2.0 \text{ A} \\
 &= 2.0 \Omega
 \end{aligned}$$

$$\begin{aligned}
 L_c &= (R_{\text{max}} / R_w) / 2 \\
 &= (2.0 \Omega / 0.002 \Omega/\text{ft.}) / 2 \\
 &= (1,000.0 \text{ ft.}) / 2 \\
 &= 500.0 \text{ ft.}
 \end{aligned}$$

So the maximum wire run for this NAC would be 500 ft. (rounding down for safety).

NAC maximum wire run quick reference tables

Table 44: VS1 panel

Current	12 AWG	14 AWG	16 AWG	18 AWG
0.5 A	2,228 ft.	1,400 ft.	879 ft.	553 ft.
1.0 A	1,088 ft.	684 ft.	429 ft.	270 ft.
1.5 A	708 ft.	445 ft.	279 ft.	175 ft.
2.0 A	518 ft.	326 ft.	204 ft.	128 ft.
2.5 A	404 ft.	254 ft.	160 ft.	100 ft.

Table 45: VS2 panel

Current	12 AWG	14 AWG	16 AWG	18 AWG
0.5 A	2217 ft.	1394 ft.	875 ft.	550 ft.
1.0 A	1,077 ft.	677 ft.	425 ft.	267 ft.
1.5 A	697 ft.	438 ft.	275 ft.	173 ft.
2.0 A	507 ft.	319 ft.	200 ft.	126 ft.
2.5 A	393 ft.	247 ft.	155 ft.	97 ft.

Notification appliance voltage drop calculation worksheet

The notification appliance voltage drop calculation worksheet is used to calculate the voltage drop of your NAC circuits over the distance of the wire you are using.

NAC 1 voltage drop calculations						
Circuit length		Total circuit current [2]		Wire resistance per 1000 ft [1]		Voltage drop
feet	x	amps	x	Ω	$\div 1000 =$	

Panel voltage		Voltage drop		End of line voltage [3]		Voltage drop		Panel voltage		Voltage drop %
19.8 V	-		=				\div	19.8 V	=	

NAC 2 voltage drop calculations						
Circuit length		Total circuit current [2]		Wire resistance per 1000 ft [1]		Voltage drop
feet	x	amps	x	Ω	$\div 1000 =$	

Panel voltage		Voltage drop		End of line voltage [3]		Voltage drop		Panel voltage		Voltage drop %
19.8 V	-		=				\div	19.8 V	=	

NAC 3 voltage drop calculations						
Circuit length		Total circuit current [2]		Wire resistance per 1000 ft [1]		Voltage drop
feet	x	amps	x	Ω	$\div 1000 =$	

Panel voltage		Voltage drop		End of line voltage [3]		Voltage drop		Panel voltage		Voltage drop %
19.8 V	-		=				\div	19.8 V	=	

NAC 4 voltage drop calculations						
Circuit length		Total circuit current [2]		Wire resistance per 1000 ft [1]		Voltage drop
feet	x	amps	x	Ω	$\div 1000 =$	

Panel voltage		Voltage drop		End of line voltage [3]		Voltage drop		Panel voltage		Voltage drop %
19.8 V	-		=				\div	19.8 V	=	

Notes

- [1] Use the manufacturer’s published wire resistance expressed in ohms per foot. For typical values, see Table 43 on page 202.
- [2] Use the Maximum operating current at worst-case VFWR from the installation or catalog sheet of each device.
- [3] For UL regulated notification appliances, this voltage must not drop below 16 VFWR. For other devices, get the minimum operating VFWR from the installation or catalog sheet.

Device loop maximum wire length worksheet

Use the instructions provided below to calculate the maximum wire length for a device loop. The maximum wire length is made up of two components: the total amount of wire and the longest circuit path.

Step 1: Total wire

Use the worksheet below to calculate the total amount of wire that you can use to construct a device loop. The total amount of wire is based on the cable manufacturer’s capacitance per foot rating. In no case shall the total amount of wire exceed the values listed in Table 46.

$$\begin{array}{rcl}
 & 700,000 & \text{pF} \\
 \text{Cable capacitance} & \div & \boxed{} \text{ pF/ft.} \\
 \hline
 \text{Total wire} & & \boxed{} \text{ ft.}
 \end{array}$$

Table 46: Maximum wire length for the loop

Wire type	18 AWG or 0.75 mm ²	16 AWG or 1.0 mm ²	14 AWG or 1.5 mm ²
Twisted pair, nonshielded 25, 36, 38 pF	20,000 ft. (6096 m)	13,888 ft. (4233 m)	13,157 ft. (4010 m)
Twisted pair, shielded 58, 82, 84 pF	8,621 ft. (2628 m)	6,098 ft. (1859 m)	5,952 ft. (1814 m)
Untwisted pair, unshielded 20, 20, 20 pF	20,000 ft. (6096 m)	20,000 ft. (6096 m)	20,000 ft. (6096 m)

Step 2: Longest path

Use the tables that follow to determine the device loop’s longest circuit path. The longest circuit path is based on wire size and type, and the number of detectors, modules, GSA-UM or -MABs installed on the loop. The distances listed are for devices

that are evenly distributed on the loop. Please contact your distributor for loop wire distances for devices on an end-loaded loop.

Note: When using the tables to calculate a wire length for the VS1 panel, do not exceed a total of 64 device addresses (any combination of detectors and modules).

In the illustration below, the longest circuit path (shown in bold lines) is 1,240 ft. (378 m). The total amount of wire comprising the loop is 1,640 ft. (500 m)

Figure 55: Device circuit path diagram

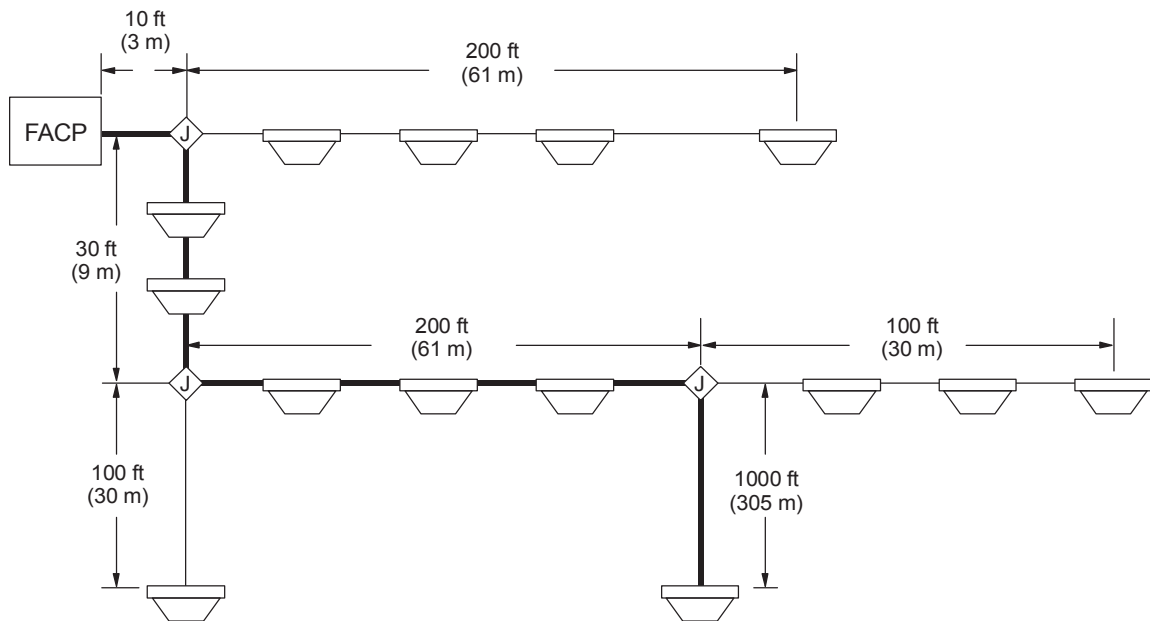

Table 47: Longest allowable circuit path with zero GSA-UM or -MABs configured for two-wire smoke detectors

Number of detectors	Number of modules (1 or 2 channel)	Maximum allowable wire distance using nontwisted, nonshielded and twisted, nonshielded wire pairs (evenly distributed)					
		18 AWG		16 AWG		14 AWG	
		ft.	m	ft.	m	ft.	m
1 to 25	0	5172	1577	8217	2505	13069	3984
26 to 50	0	5172	1577	8217	2505	13069	3984
51 to 75	0	5172	1577	8217	2505	13069	3984
76 to 100	0	5172	1577	8217	2505	13069	3984
101 to 125	0	5172	1577	8217	2505	13069	3984
0	1 to 25	5172	1577	8217	2505	13069	3984
1 to 25	1 to 25	5172	1577	8217	2505	13069	3984
26 to 50	1 to 25	5172	1577	8217	2505	13069	3984
51 to 75	1 to 25	5172	1577	8217	2505	13069	3984
76 to 100	1 to 25	5172	1577	8217	2505	13069	3984
101 to 125	1 to 25	5172	1577	8217	2505	13069	3984
0	26 to 50	5172	1577	8217	2505	13069	3984
1 to 25	26 to 50	5172	1577	8217	2505	13069	3984
26 to 50	26 to 50	5172	1577	8217	2505	13069	3984
51 to 75	26 to 50	5172	1577	8217	2505	13069	3984
76 to 100	26 to 50	5172	1577	8217	2505	13069	3984
101 to 125	26 to 50	4936	1504	7841	2390	12471	3801
0	51 to 75	4968	1514	7892	2406	12553	3826
1 to 25	51 to 75	4525	1379	7188	2191	11433	3485
26 to 50	51 to 75	4095	1248	6506	1983	10348	3154
51 to 75	51 to 75	3682	1122	5849	1783	9303	2836
76 to 100	51 to 75	3283	1001	5216	1590	8296	2529
101 to 125	51 to 75	2899	884	4605	1404	7324	2232
0	76 to 100	3241	988	5150	1570	8190	2496
1 to 25	76 to 100	2901	884	4608	1405	7329	2234
26 to 50	76 to 100	2566	782	4077	1243	6485	1977
51 to 75	76 to 100	2239	683	3557	1084	5658	1725
76 to 100	76 to 100	1919	585	3049	929	4849	1478
101 to 125	76 to 100	1606	489	2551	777	4057	1237
0	101 to 125	2087	636	3316	1011	5273	1607
1 to 25	101 to 125	1795	547	2852	869	4536	1383
26 to 50	101 to 125	1507	459	2394	730	3808	1161
51 to 75	101 to 125	1223	373	1943	592	3090	942
76 to 100	101 to 125	942	287	1497	456	2381	726
101 to 125	101 to 125	666	203	1057	322	1682	513

Table 48: Longest allowable circuit path with 1 to 5 GSA-UM or -MABs configured for two-wire smoke detectors

Number of detectors	Number of modules (1 or 2 channel)	Maximum allowable wire distance using nontwisted, nonshielded and twisted, nonshielded wire pairs (evenly distributed)					
		18 AWG		16 AWG		14 AWG	
		ft.	m	ft.	m	ft.	m
1 to 25	0	5172	1577	8217	2505	13069	3984
26 to 50	0	5172	1577	8217	2505	13069	3984
51 to 75	0	5172	1577	8217	2505	13069	3984
76 to 100	0	5172	1577	8217	2505	13069	3984
101 to 125	0	4980	1518	7912	2411	12583	3835
0	1 to 25	5172	1577	8217	2505	13069	3984
1 to 25	1 to 25	4861	1482	7722	2354	12281	3743
26 to 50	1 to 25	4345	1324	6903	2104	10979	3346
51 to 75	1 to 25	3843	1171	6105	1861	9710	2959
76 to 100	1 to 25	3359	1024	5337	1627	8488	2587
101 to 125	1 to 25	2895	882	4599	1402	7315	2230
0	26 to 50	3550	1082	5640	1719	8971	2734
1 to 25	26 to 50	3145	958	4996	1523	7945	2422
26 to 50	26 to 50	2742	836	4356	1328	6928	2112
51 to 75	26 to 50	2348	716	3730	1137	5932	1808
76 to 100	26 to 50	1963	598	3119	951	4961	1512
101 to 125	26 to 50	1589	484	2525	770	4016	1224
0	51 to 75	2334	712	3709	1130	5898	1798
1 to 25	51 to 75	1986	605	3156	962	5019	1530
26 to 50	51 to 75	1643	501	2610	795	4151	1265
51 to 75	51 to 75	1305	398	2073	632	3297	1005
76 to 100	51 to 75	973	296	1545	471	2458	749
101 to 125	51 to 75	647	197	1027	313	1634	498
0	76 to 100	1426	435	2265	691	3603	1098
1 to 25	76 to 100	1114	339	1769	539	2814	858
26 to 50	76 to 100	805	245	1279	390	2034	620
51 to 75	76 to 100	500	152	795	242	1264	385
76 to 100	76 to 100	199	61	317	97	504	154
101 to 125	76 to 100	0	0	0	0	0	0
0	101 to 115	971	296	1543	470	2454	748
1 to 25	101 to 115	674	206	1071	327	1704	519
26 to 50	101 to 115	380	116	604	184	961	293
51 to 75	101 to 115	89	27	142	43	226	69
76 to 100	101 to 115	0	0	0	0	0	0
101 to 125	101 to 115	0	0	0	0	0	0

Table 49: Longest allowable circuit path with 6 to 10 GSA-UM or -MABs configured for two-wire smoke detectors

Number of detectors	Number of modules (1 or 2 channel)	Maximum allowable wire distance using nontwisted, nonshielded and twisted, nonshielded wire pairs (evenly distributed)					
		18 AWG		16 AWG		14 AWG	
		ft.	m	ft.	m	ft.	m
1 to 25	0	3543	1080	5629	1716	8952	2729
26 to 50	0	2818	859	4476	1364	7120	2170
51 to 75	0	2092	638	3323	1013	5285	1611
76 to 100	0	1365	416	2169	661	3450	1051
101 to 125	0	639	195	1015	309	1614	492
0	1 to 25	2895	882	4599	1402	7314	2229
1 to 25	1 to 25	2503	763	3976	1212	6324	1927
26 to 50	1 to 25	1778	542	2825	861	4493	1369
51 to 75	1 to 25	1053	321	1672	510	2660	811
76 to 100	1 to 25	327	100	519	158	825	252
101 to 125	1 to 25	0	0	0	0	0	0
0	26 to 50	1910	582	3035	925	4827	1471
1 to 25	26 to 50	1465	446	2327	709	3700	1128
26 to 50	26 to 50	740	225	1175	358	1869	570
51 to 75	26 to 50	14	4	23	7	36	11
76 to 100	26 to 50	0	0	0	0	0	0
101 to 125	26 to 50	0	0	0	0	0	0
0	51 to 75	1114	340	1770	539	2814	858
1 to 25	51 to 75	427	130	678	207	1079	329
26 to 50	51 to 75	0	0	0	0	0	0
51 to 75	51 to 75	0	0	0	0	0	0
76 to 100	51 to 75	0	0	0	0	0	0
101 to 125	51 to 75	0	0	0	0	0	0
0	76 to 100	114	35	182	55	289	88
1 to 25	76 to 100	0	0	0	0	0	0
26 to 50	76 to 100	0	0	0	0	0	0
51 to 75	76 to 100	0	0	0	0	0	0
76 to 100	76 to 100	0	0	0	0	0	0
101 to 125	76 to 100	0	0	0	0	0	0
0	101 to 125	0	0	0	0	0	0
1 to 25	101 to 125	0	0	0	0	0	0
26 to 50	101 to 125	0	0	0	0	0	0
51 to 75	101 to 125	0	0	0	0	0	0
76 to 100	101 to 125	0	0	0	0	0	0
101 to 125	101 to 125	0	0	0	0	0	0

Table 50: Longest allowable circuit path with 11 to 15 GSA-UM or -MABs configured for two-wire smoke detectors

Number of detectors	Number of modules (1 or 2 channel)	Maximum allowable wire distance using nontwisted, nonshielded and twisted, nonshielded wire pairs (evenly distributed)					
		18 AWG		16 AWG		14 AWG	
		ft.	m	ft.	m	ft.	m
1 to 25	0	1817	554	2887	880	4592	1400
26 to 50	0	1070	326	1699	518	2703	824
51 to 75	0	321	98	510	156	811	247
76 to 100	0	0	0	0	0	0	0
101 to 125	0	0	0	0	0	0	0
0	1 to 25	1490	454	2367	721	3764	1147
1 to 25	1 to 25	745	227	1184	361	1883	574
26 to 50	1 to 25	0	0	0	0	0	0
51 to 75	1 to 25	0	0	0	0	0	0
76 to 100	1 to 25	0	0	0	0	0	0
101 to 125	1 to 25	0	0	0	0	0	0
0	26 to 50	421	128	668	204	1063	324
1 to 25	26 to 50	0	0	0	0	0	0
26 to 50	26 to 50	0	0	0	0	0	0
51 to 75	26 to 50	0	0	0	0	0	0
76 to 100	26 to 50	0	0	0	0	0	0
101 to 125	26 to 50	0	0	0	0	0	0
0	51 to 75	0	0	0	0	0	0
1 to 25	51 to 75	0	0	0	0	0	0
26 to 50	51 to 75	0	0	0	0	0	0
51 to 75	51 to 75	0	0	0	0	0	0
76 to 100	51 to 75	0	0	0	0	0	0
101 to 125	51 to 75	0	0	0	0	0	0
0	76 to 95	0	0	0	0	0	0
1 to 25	76 to 95	0	0	0	0	0	0
26 to 50	76 to 95	0	0	0	0	0	0
51 to 75	76 to 95	0	0	0	0	0	0
76 to 100	76 to 95	0	0	0	0	0	0
101 to 125	76 to 95	0	0	0	0	0	0

Event notification

Active

Print Yes No

NET Yes No

Dialer Acct 1 Acct 1 & 2 Acct 2 None

Code

--	--	--	--

 (four-digit coded output)

CID

--	--	--

Trouble

Print Yes No

NET Yes No

Dialer Acct 1 Acct 1 & 2 Acct 2 None

Code

--	--	--	--

 (four-digit coded output)

CID

--	--	--

Disable

Print Yes No

NET Yes No

Dialer Acct 1 Acct 1 & 2 Acct 2 None

Code

--	--	--	--

 (four-digit coded output)

CID

--	--	--

Prealarm

Print Yes No

NET Yes No

Dialer Acct 1 Acct 1 & 2 Acct 2 None

Code

--	--	--	--

 (four-digit coded output)

CID

--	--	--

Alarm verify

Print Yes No

NET Yes No

Dialer Acct 1 Acct 1 & 2 Acct 2 None

Code

--	--	--	--

 (four-digit coded output)

CID

--	--	--

Maintenance alert

Print Yes NoNET Yes NoDialer Acct 1 Acct 1 & 2 Acct 2 NoneCode

--	--	--	--

 (four-digit coded output)CID

--	--	--

Test

Print Yes NoNET Yes NoDialer Acct 1 Acct 1 & 2 Acct 2 NoneCode

--	--	--	--

 (four-digit coded output)CID

--	--	--

Loop worksheet

The loop worksheet is used to document your loop settings.

Note: For default settings, see “Factory default settings” on page 35.

Loop class

Loop 1 class Class B Class ALoop 2 class Class B Class AMapping Disabled EnabledLoop 2 enable Yes No

Annunciator

Class Class B Class A
 Type Off LCD-C LCD LED Graphic
 Expanders None 1 or 2

Label Line 1																				
Label Line 2																				

Event notification

Trouble

Print Yes No
 NET Yes No
 Dialer Acct 1 Acct 1 & 2 Acct 2 None
 Code

--	--	--	--

 (four-digit coded output)
 CID

--	--	--

Remote devices

Dialer

Type Dual line Single line Modem only None

Account 1

ID

--	--	--	--

 (four-digit account ID code)
 Primary receiver

--	--	--	--	--	--	--	--	--	--	--	--	--	--	--	--	--	--	--	--

 Secondary receiver

--	--	--	--	--	--	--	--	--	--	--	--	--	--	--	--	--	--	--	--

 Format CID
 Send restorals Yes No
 Retry time

--	--

 (01 - 45 seconds)
 Retry count

--	--

 (01 - 10 attempts)
 Event notification Device reporting Zone reporting Event reporting

Account 2

ID

--	--	--	--

 (four-digit account ID code)
 Primary receiver

--	--	--	--	--	--	--	--	--	--	--	--	--	--	--	--	--	--	--	--

 Secondary receiver

--	--	--	--	--	--	--	--	--	--	--	--	--	--	--	--	--	--	--	--

 Format CID
 Send restorals Yes No
 Retry time

--	--

 (01 - 45 seconds)

Panel operation worksheet

The panel operation worksheet is used to document the configuration and settings of your control panel programming options.

Note: For default settings, see “Factory default settings” on page 35.

Language	<input type="checkbox"/> English	<input type="checkbox"/> French	
Marketplace	<input type="checkbox"/> U.S.	<input type="checkbox"/> Canada	
AC fail delay	<input type="checkbox"/> Off	<table border="1" style="display: inline-table; width: 40px; height: 20px;"></table>	(01 – 15 hours)
Zone resound	<input type="checkbox"/> Off	<input type="checkbox"/> On	
Reset inhibit	<input type="checkbox"/> Off	<input type="checkbox"/> 1 minute	
Auto signal silence	<input type="checkbox"/> Off	<table border="1" style="display: inline-table; width: 40px; height: 20px;"></table>	(05 – 30 minutes)
In suite signal sil.		<table border="1" style="display: inline-table; width: 40px; height: 20px;"></table>	(1 – 10 minutes)
Day start	Start time	<table border="1" style="display: inline-table; width: 40px; height: 20px;"></table>	End time <table border="1" style="display: inline-table; width: 40px; height: 20px;"></table>
Night start	Start time	<table border="1" style="display: inline-table; width: 40px; height: 20px;"></table>	End time <table border="1" style="display: inline-table; width: 40px; height: 20px;"></table>
Date format	<input type="checkbox"/> U.S. (MM/DD/YYYY)	<input type="checkbox"/> Canada (DD/MM/YYYY)	
Event notification	<input type="checkbox"/> Zone/device reporting	<input type="checkbox"/> Zone only reporting	<input type="checkbox"/> Device only reporting
LCD banner			
Line 1	<table border="1" style="width: 100%; height: 20px;"></table>		
Line 2	<table border="1" style="width: 100%; height: 20px;"></table>		
Aux power reset	<input type="checkbox"/> On	<input type="checkbox"/> Off	
User key #1	<input type="checkbox"/> Enabled	<input type="checkbox"/> Disabled	
User key #2	<input type="checkbox"/> Enabled	<input type="checkbox"/> Disabled	

Disable

Print Yes No

NET Yes No

Dialer Acct 1 Acct 1 & 2 Acct 2 None

Code

--	--	--	--

 (four-digit coded output)

CID

--	--	--

Prealarm

Print Yes No

NET Yes No

Dialer Acct 1 Acct 1 & 2 Acct 2 None

Code

--	--	--	--

 (four-digit coded output)

CID

--	--	--

Alarm verify

Print Yes No

NET Yes No

Dialer Acct 1 Acct 1 & 2 Acct 2 None

Code

--	--	--	--

 (four-digit coded output)

CID

--	--	--

Maintenance alert

Print Yes No

NET Yes No

Dialer Acct 1 Acct 1 & 2 Acct 2 None

Code

--	--	--	--

 (four-digit coded output)

CID

--	--	--

Test

Print Yes No

NET Yes No

Dialer Acct 1 Acct 1 & 2 Acct 2 None

Code

--	--	--	--

 (four-digit coded output)

CID

--	--	--

Appendix C

Front panel menu flowcharts

Summary

This appendix shows menu flowcharts for all front panel operations and programming.

Content

Main menu	224
Reports menu (1 of 2)	225
Reports menu (2 of 2)	226
Test menu	227
Control menu	228
Program menu	229
Program: Programmable Keys menu	230
Advanced Program menu	231
Advanced Program: Loop Configuration menu	232
Advanced Program: Correlation Groups menu	233
Advanced Program: Loop Configuration — Device menu	234
Advanced Program: Panel Configuration menu	235
Advanced Program: Panel Configuration — CMS Device menu	236
Advanced Program: Panel Operation menu	237
Advanced Program: Panel Events menu	238
Advanced Program: Loop Events menu	239
Advanced Program: Unconfigured Alarm menu	240
Advanced Program: Common Trouble menu	240
Auto Program command menu flow	241
Incremental Program menu	242
Diagnostics menu	243

Main menu

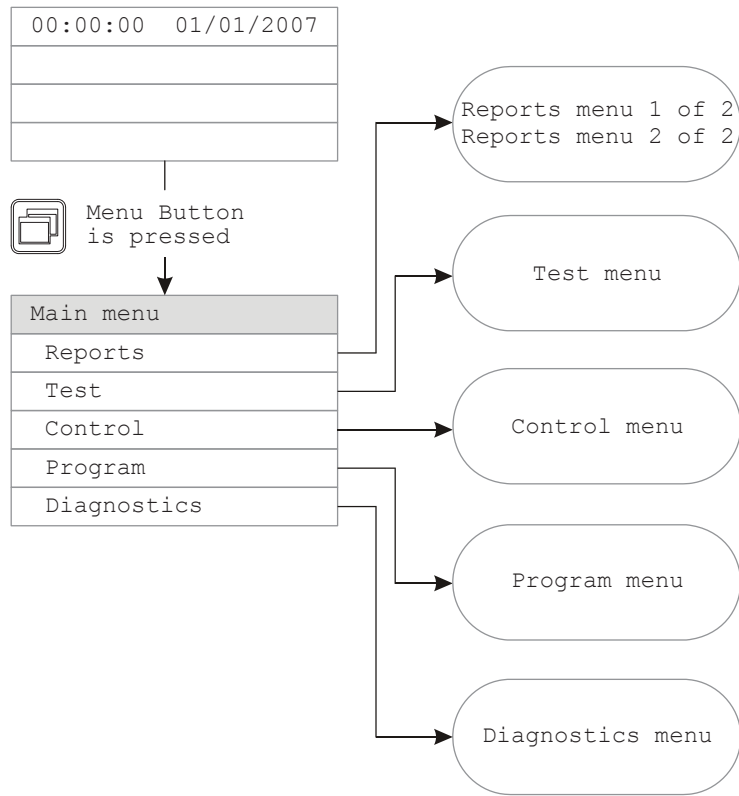

Reports menu (1 of 2)

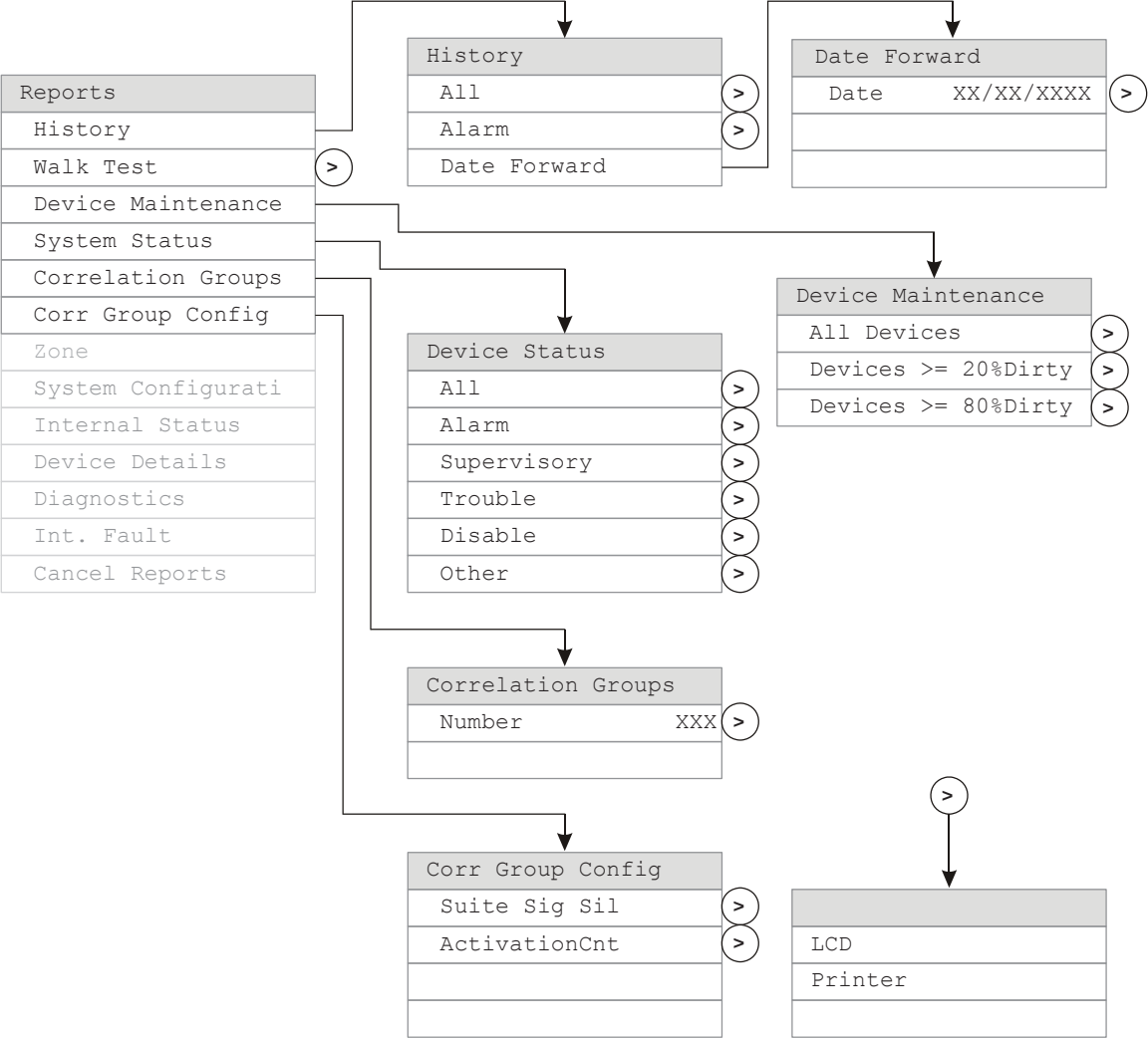

Reports menu (2 of 2)

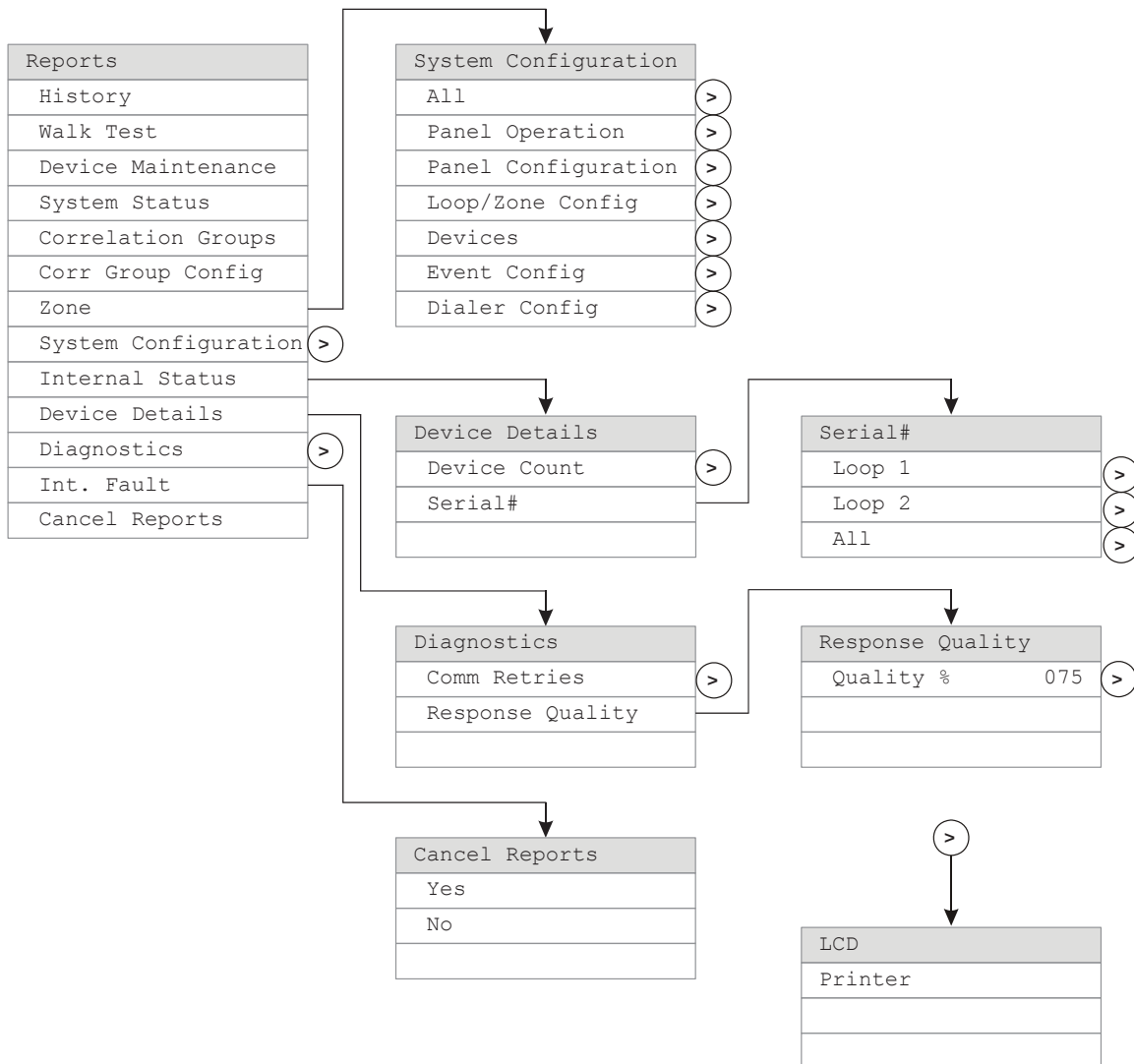

Test menu

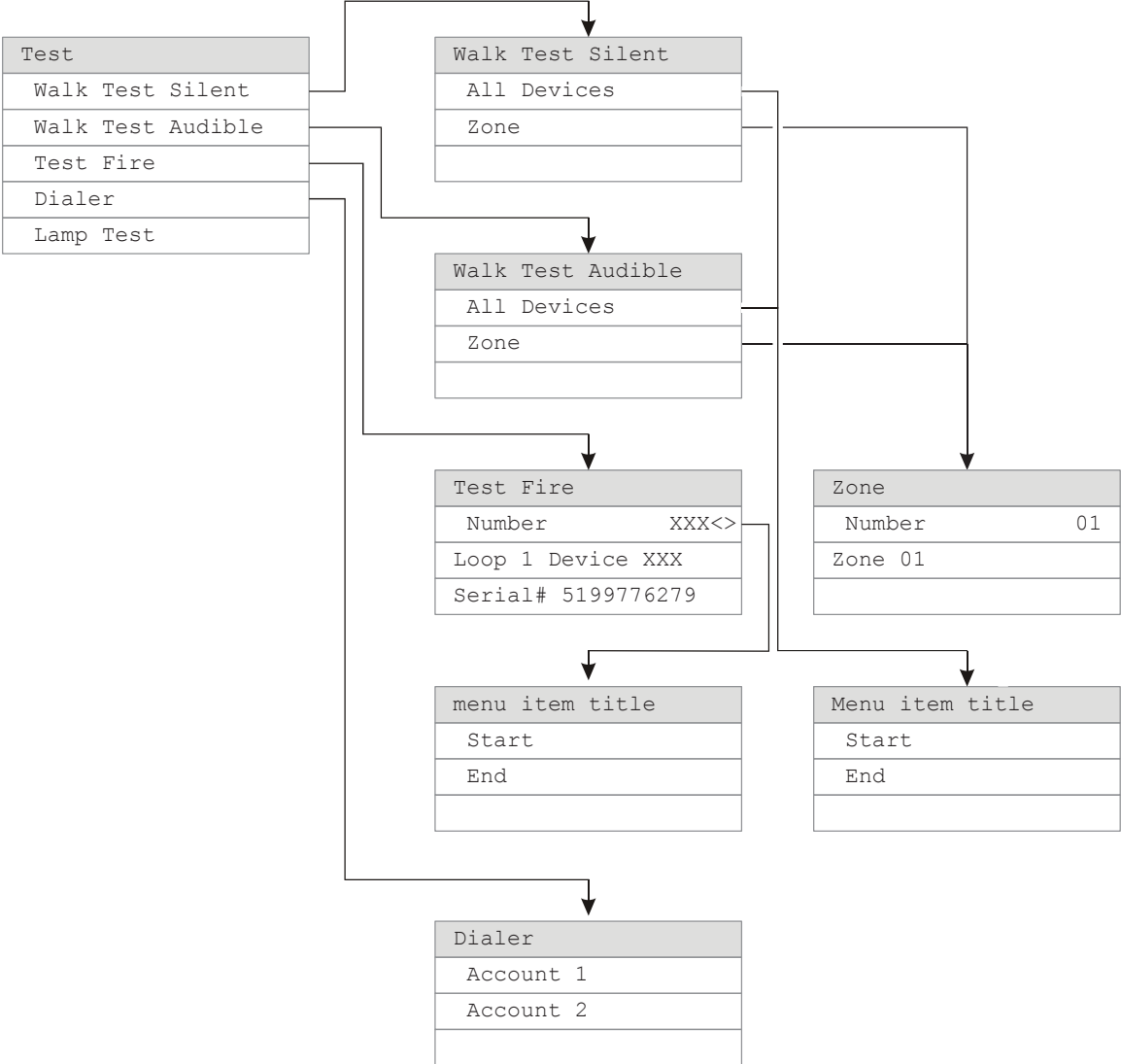

Control menu

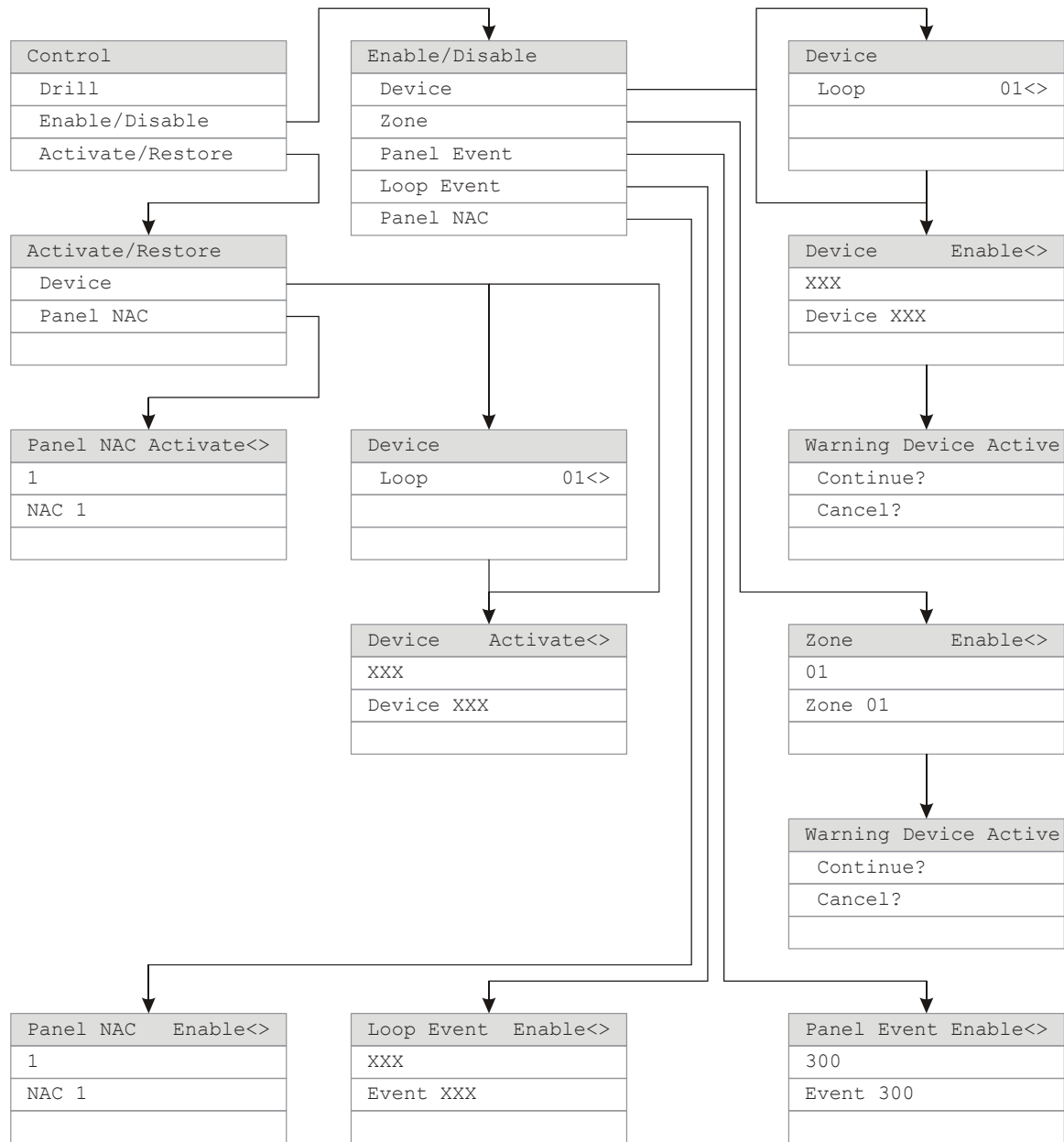

Program menu

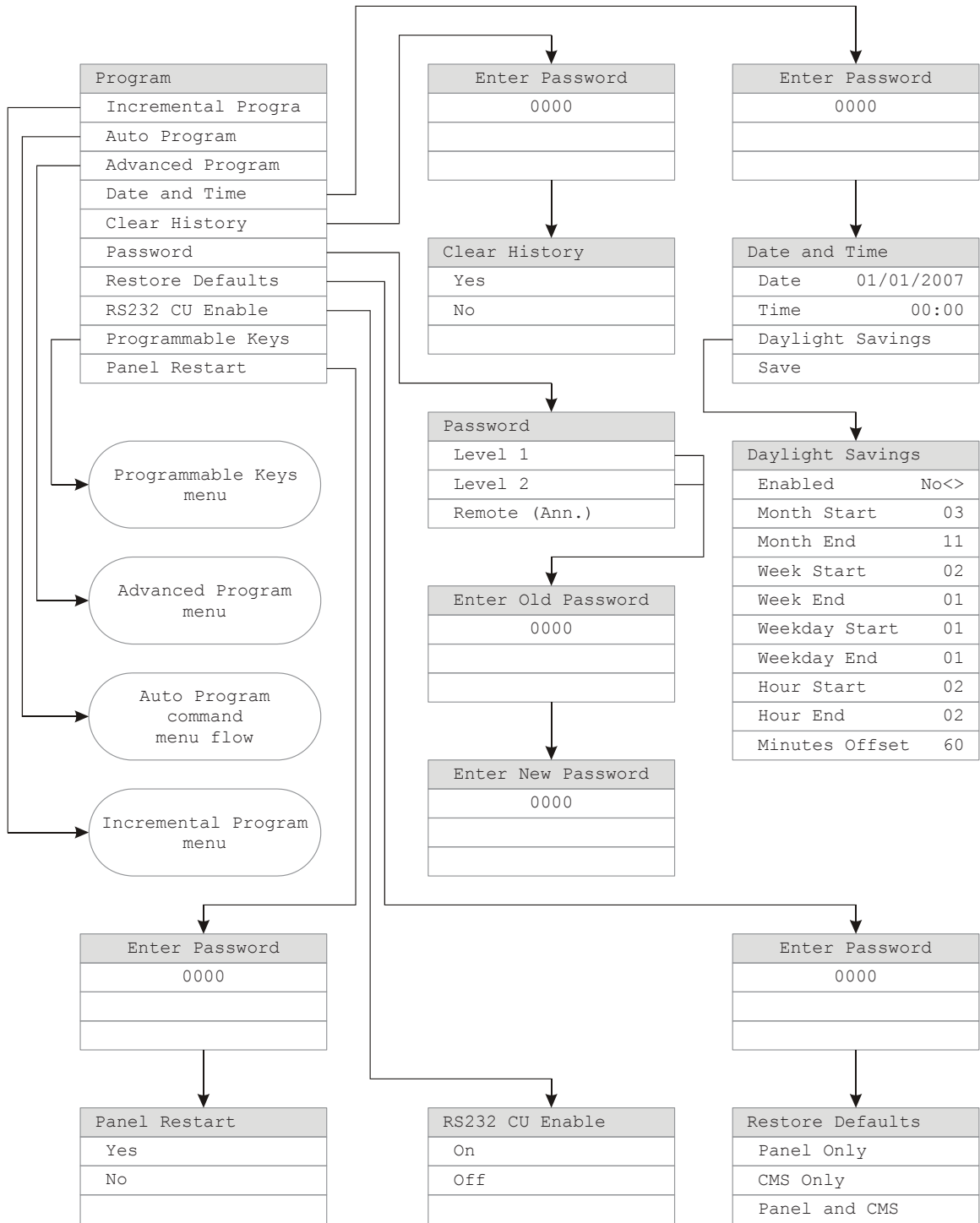

Program: Programmable Keys menu

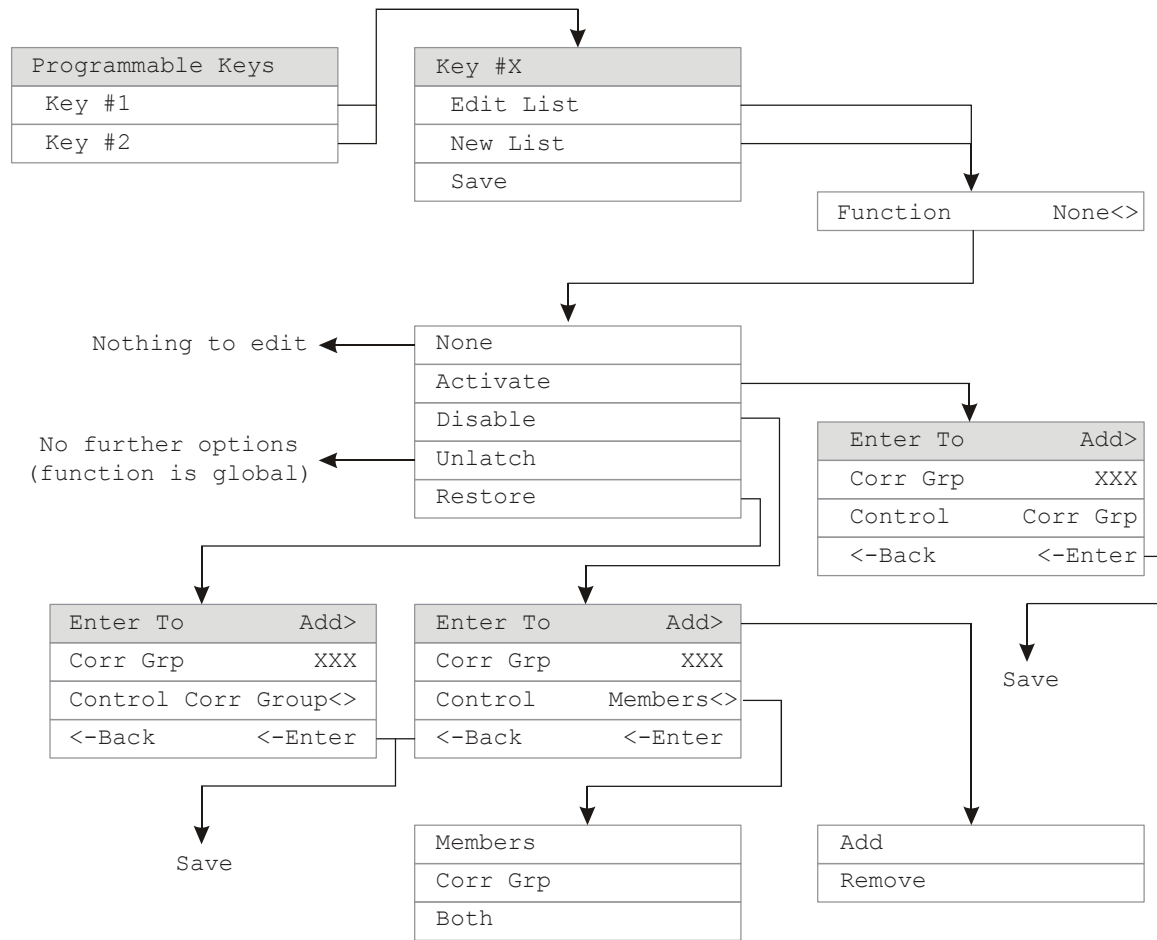

Advanced Program menu

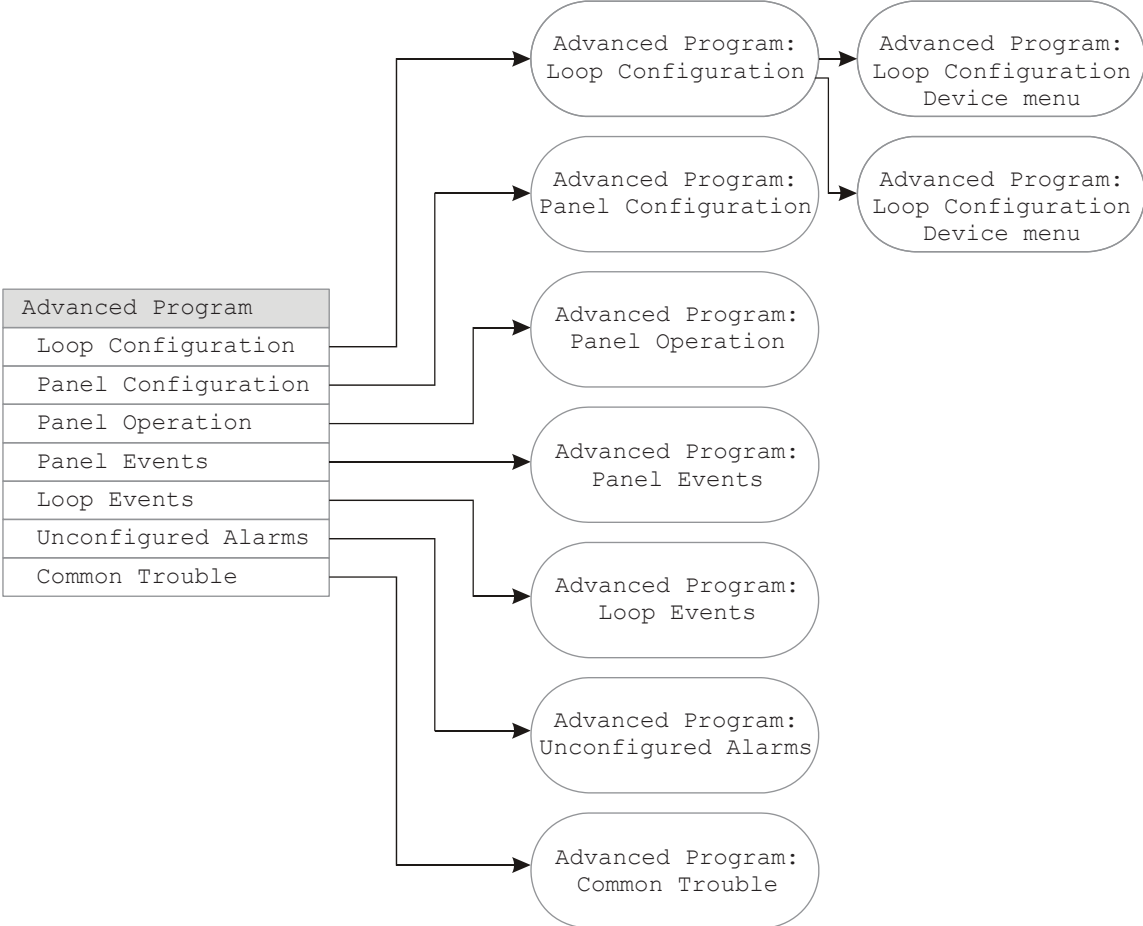

Advanced Program: Loop Configuration menu

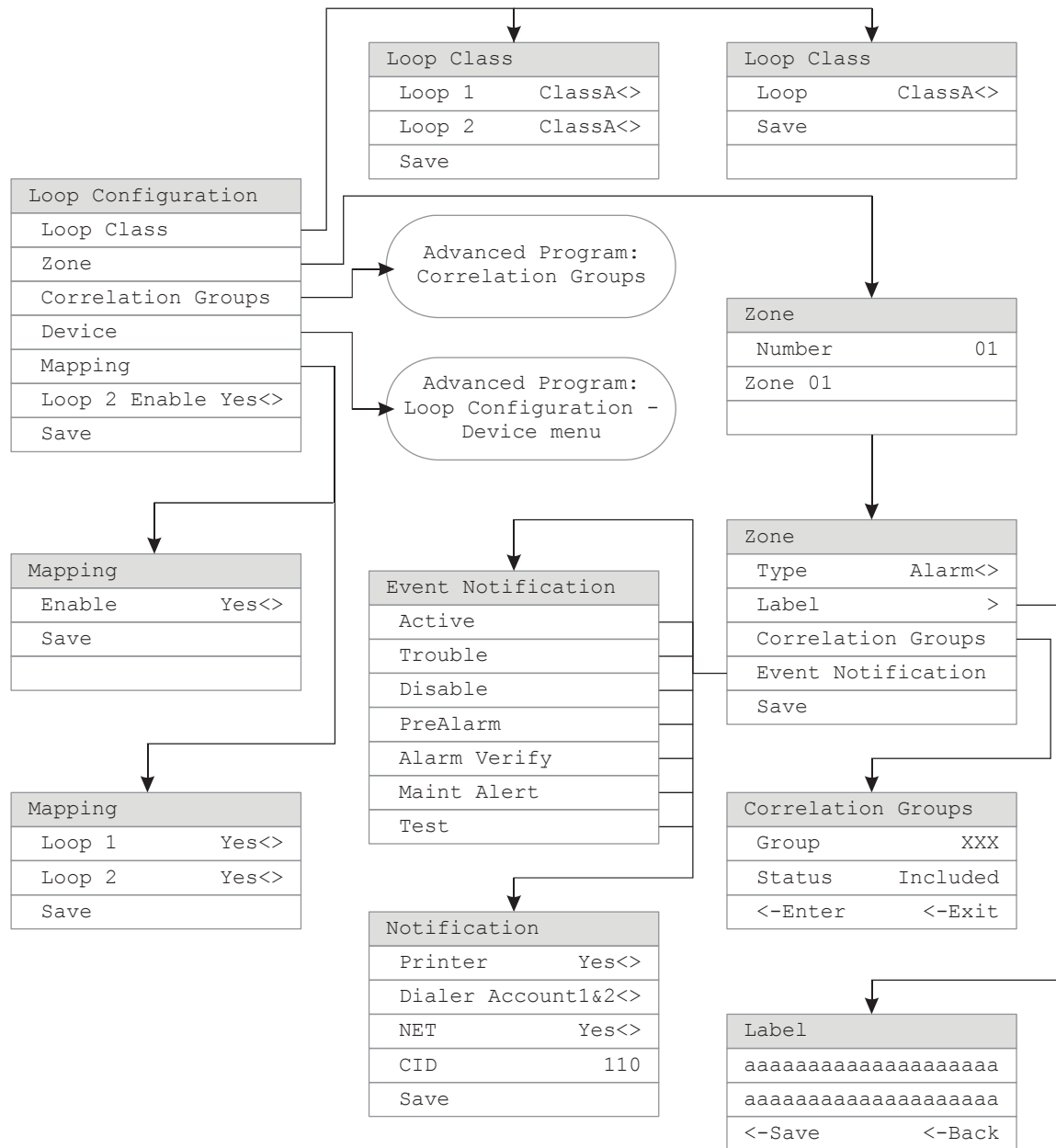

Advanced Program: Correlation Groups menu

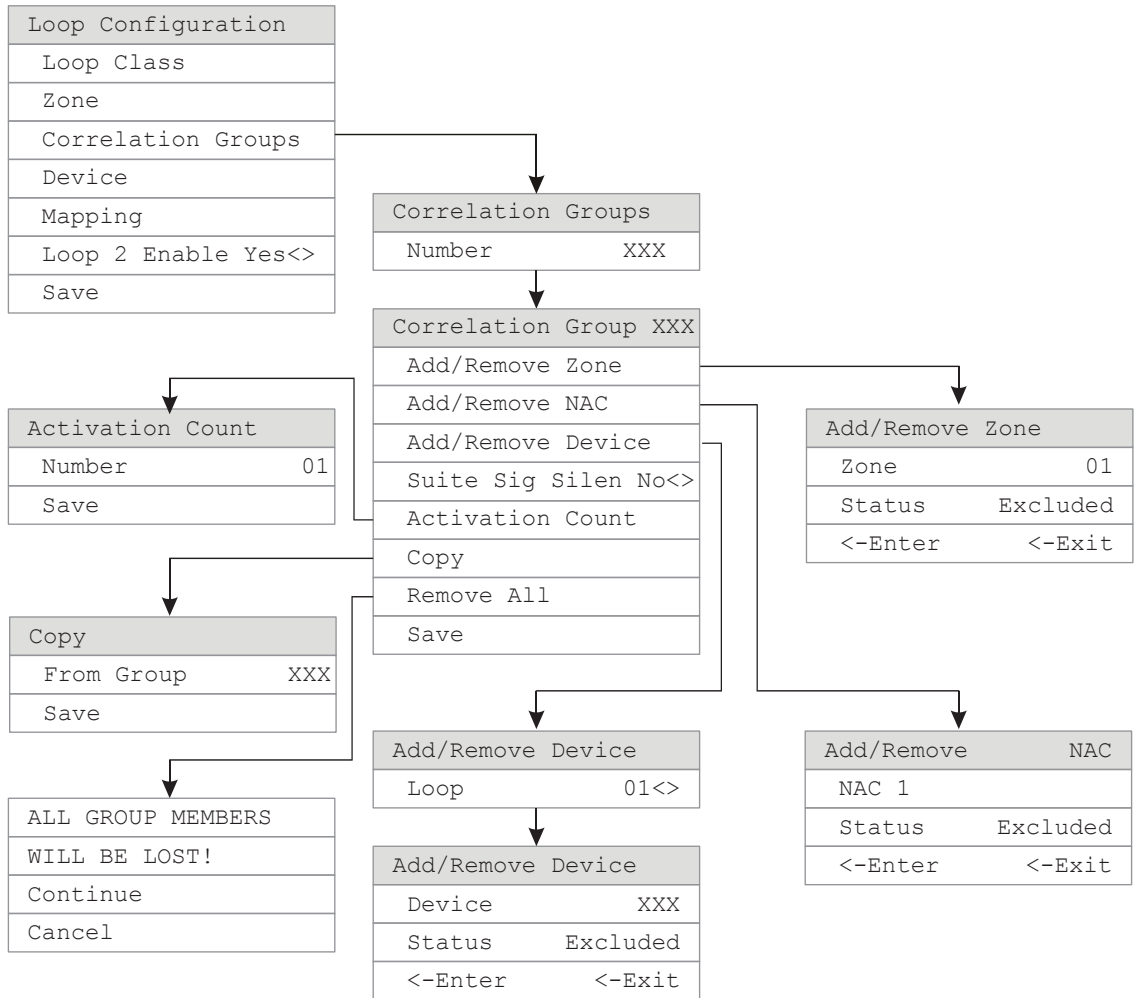

Advanced Program: Loop Configuration – Device menu

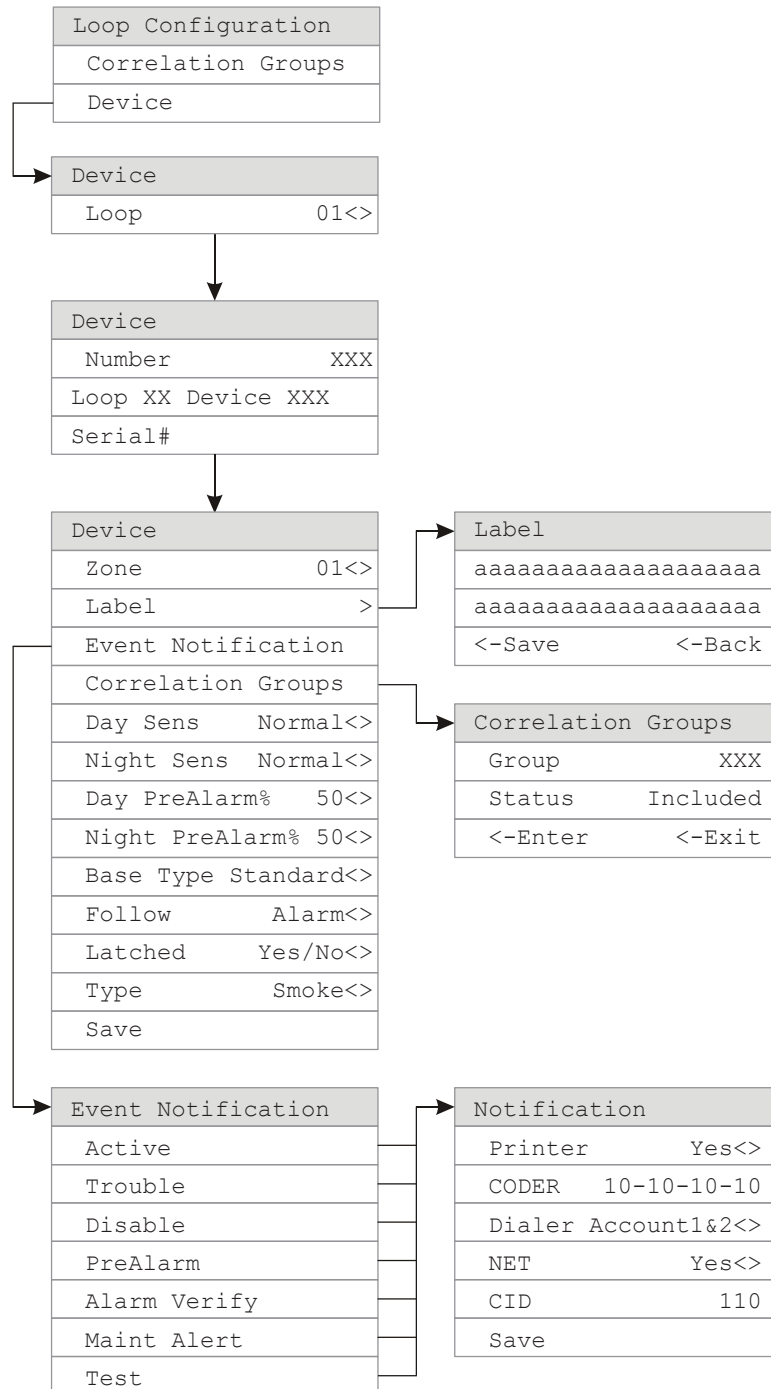

Advanced Program: Panel Configuration menu

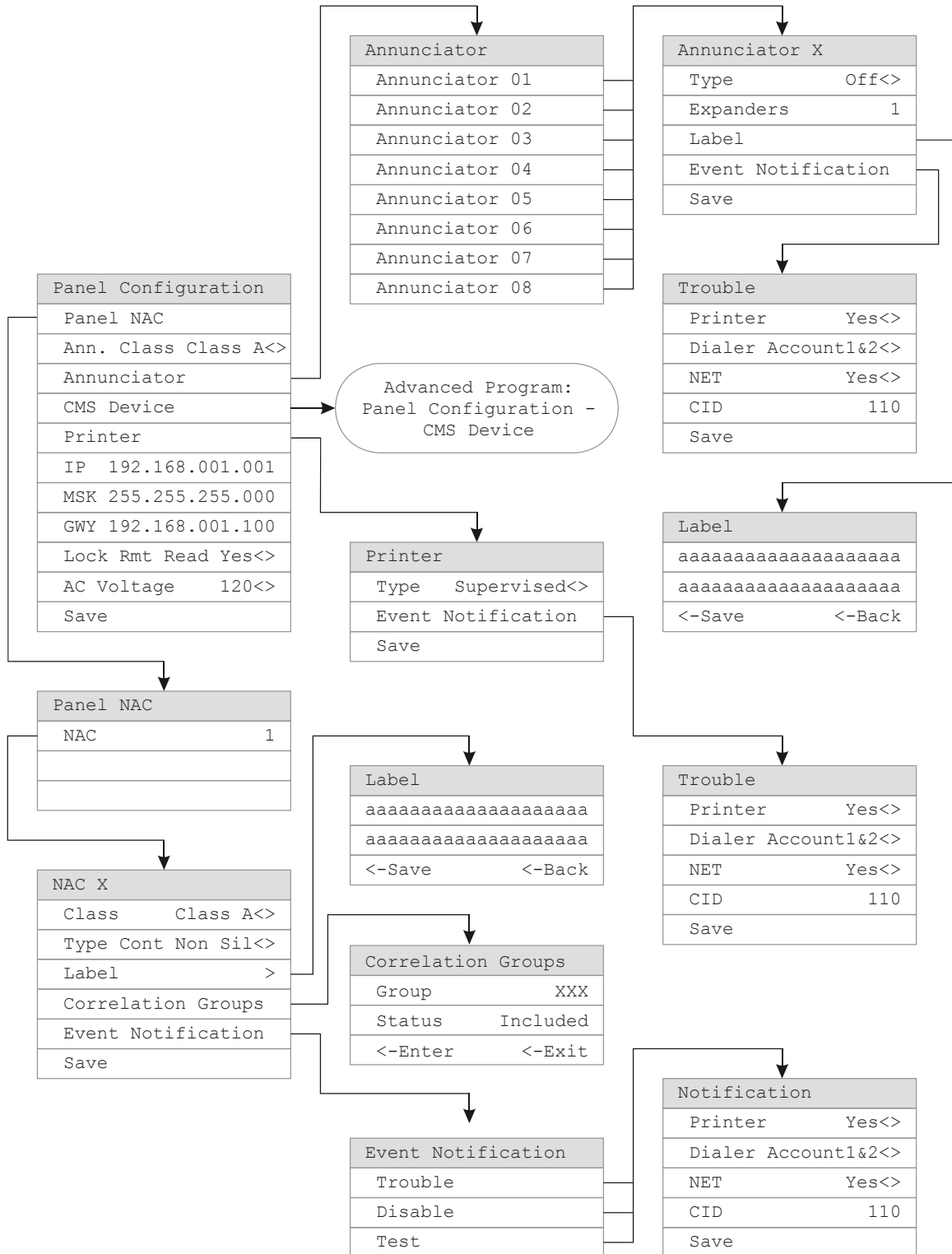

Advanced Program: Panel Configuration – CMS Device menu

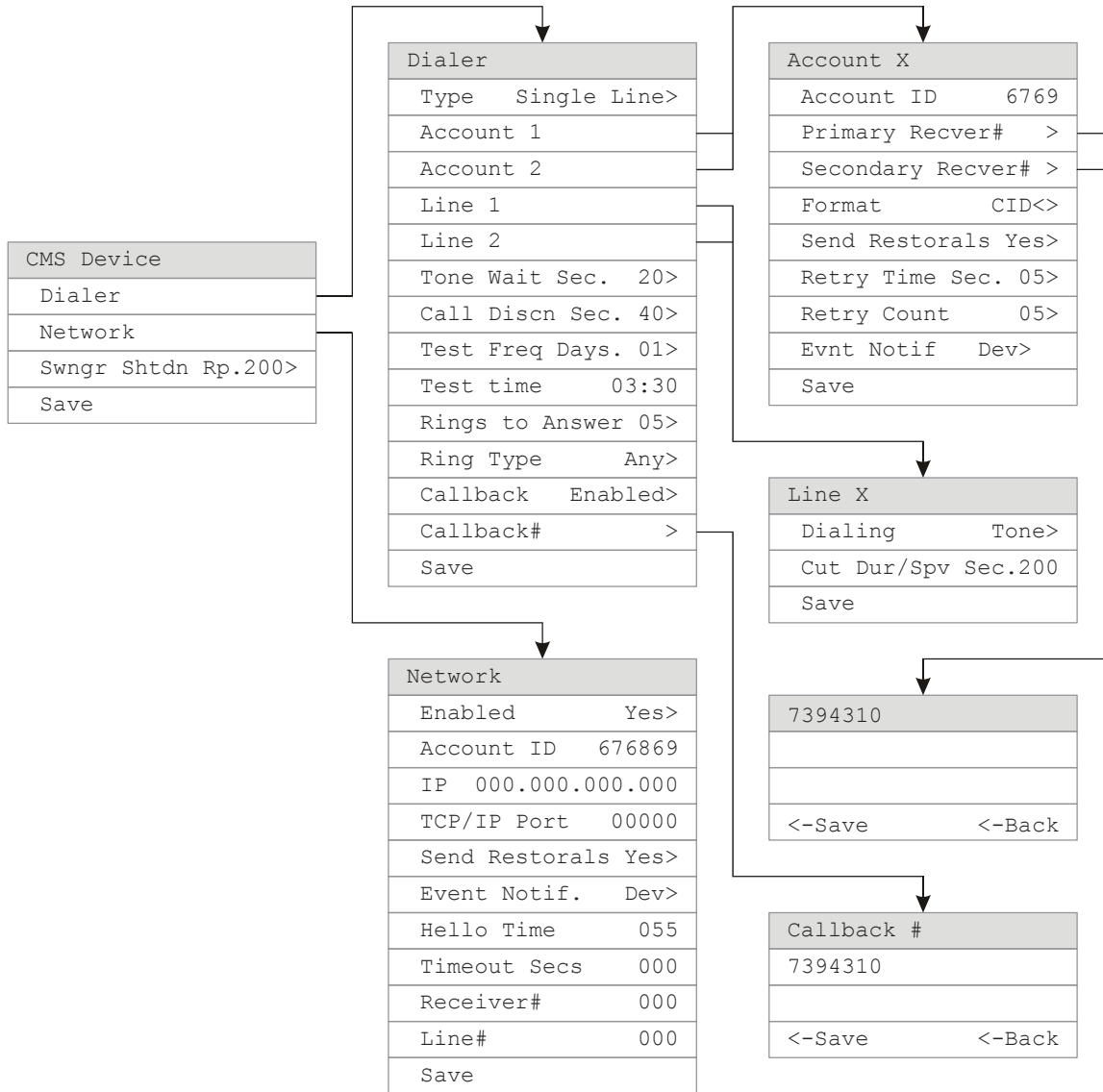

Advanced Program: Panel Operation menu

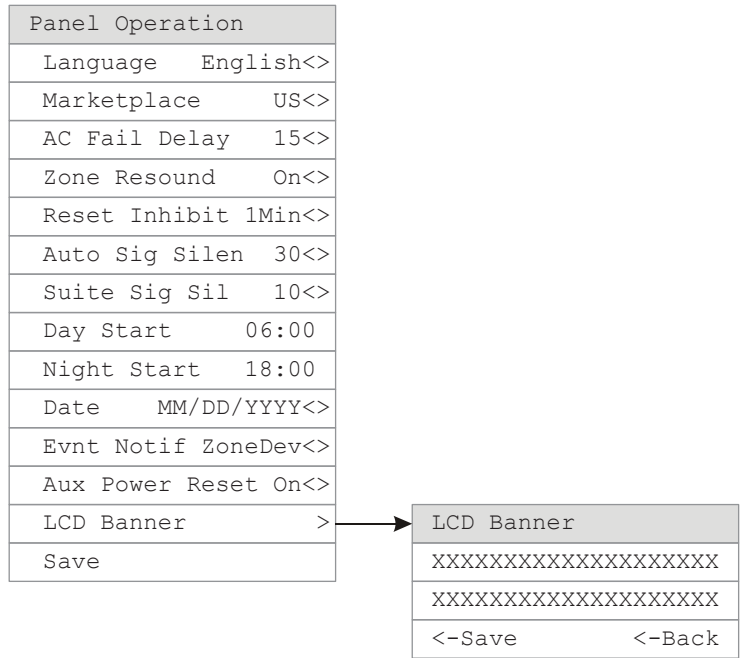

Advanced Program: Panel Events menu

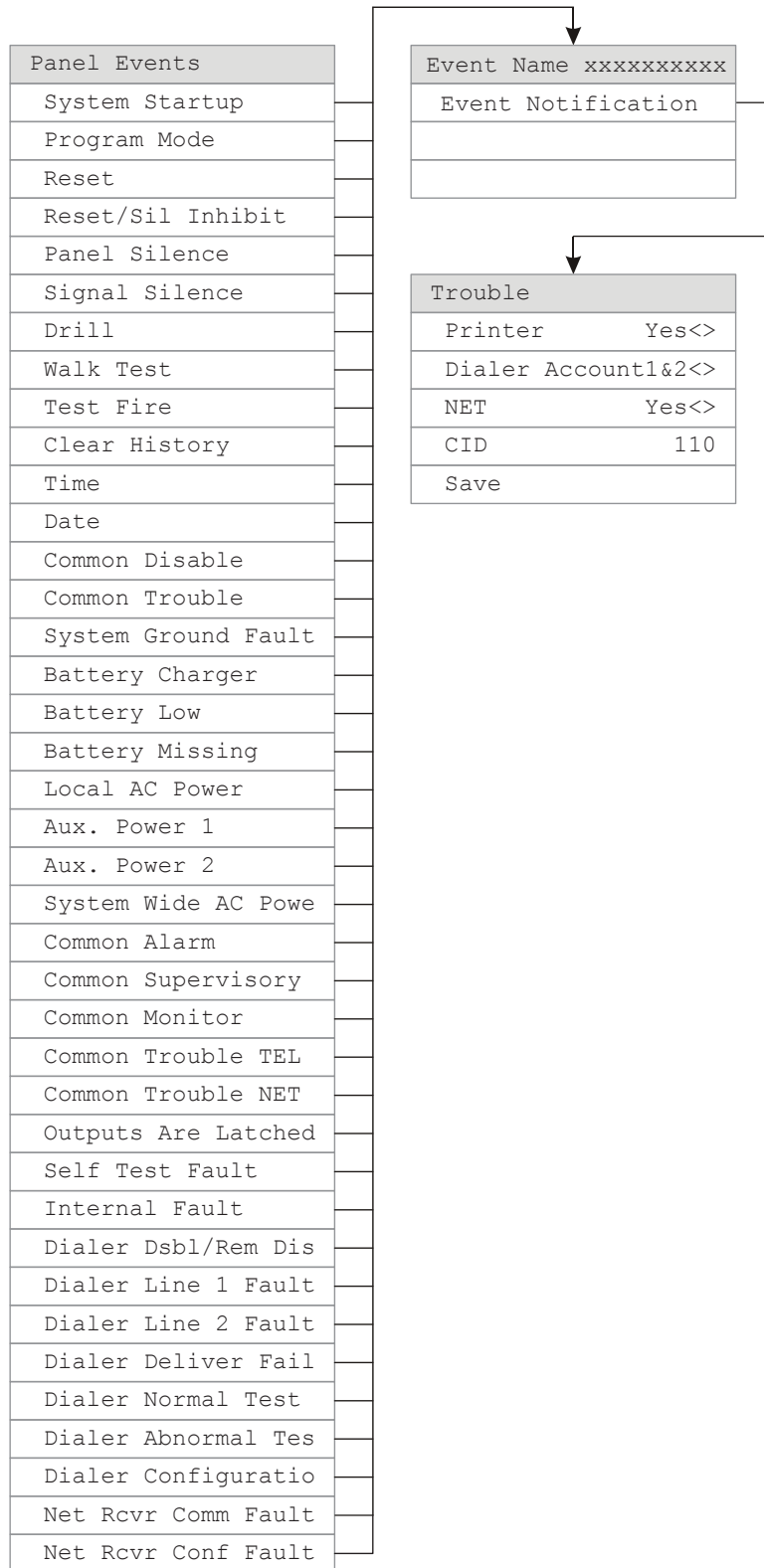

Advanced Program: Loop Events menu

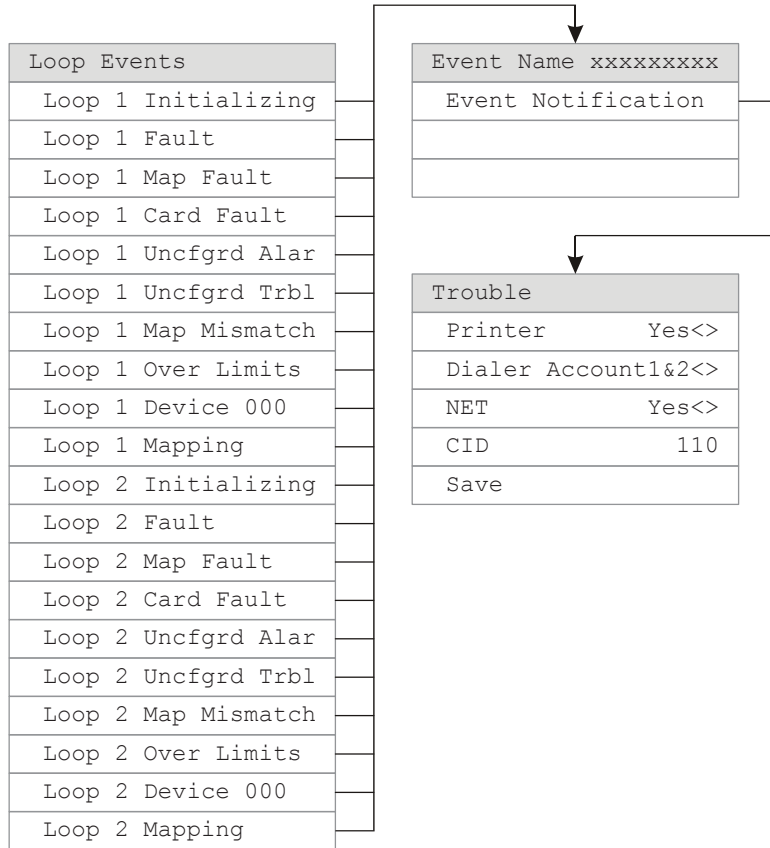

Advanced Program: Unconfigured Alarm menu

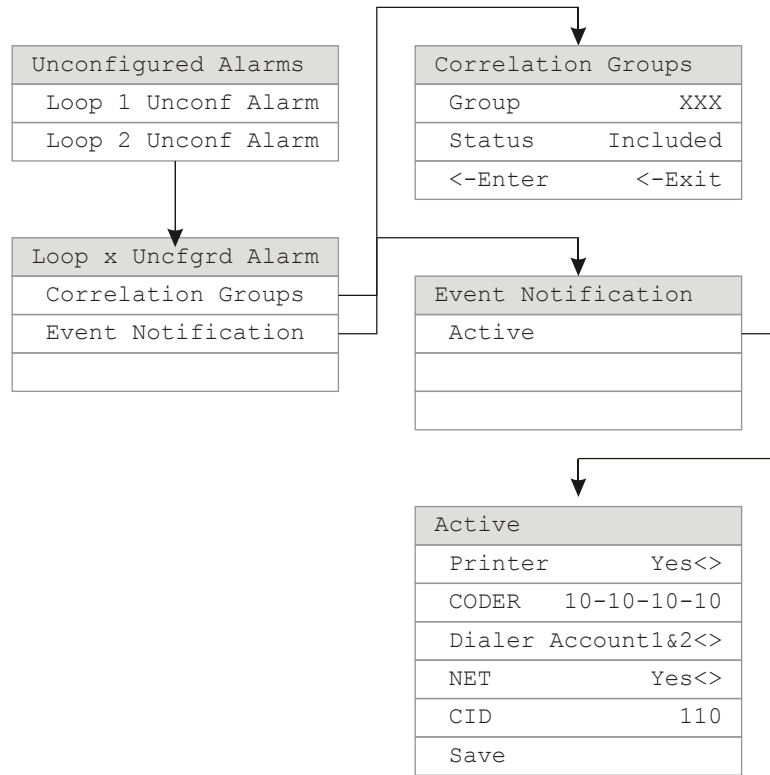

Advanced Program: Common Trouble menu

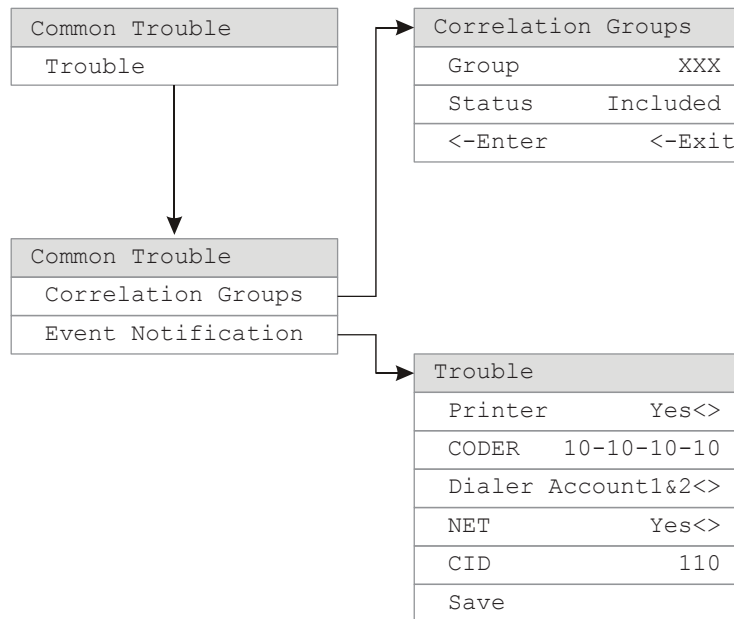

Auto Program command menu flow

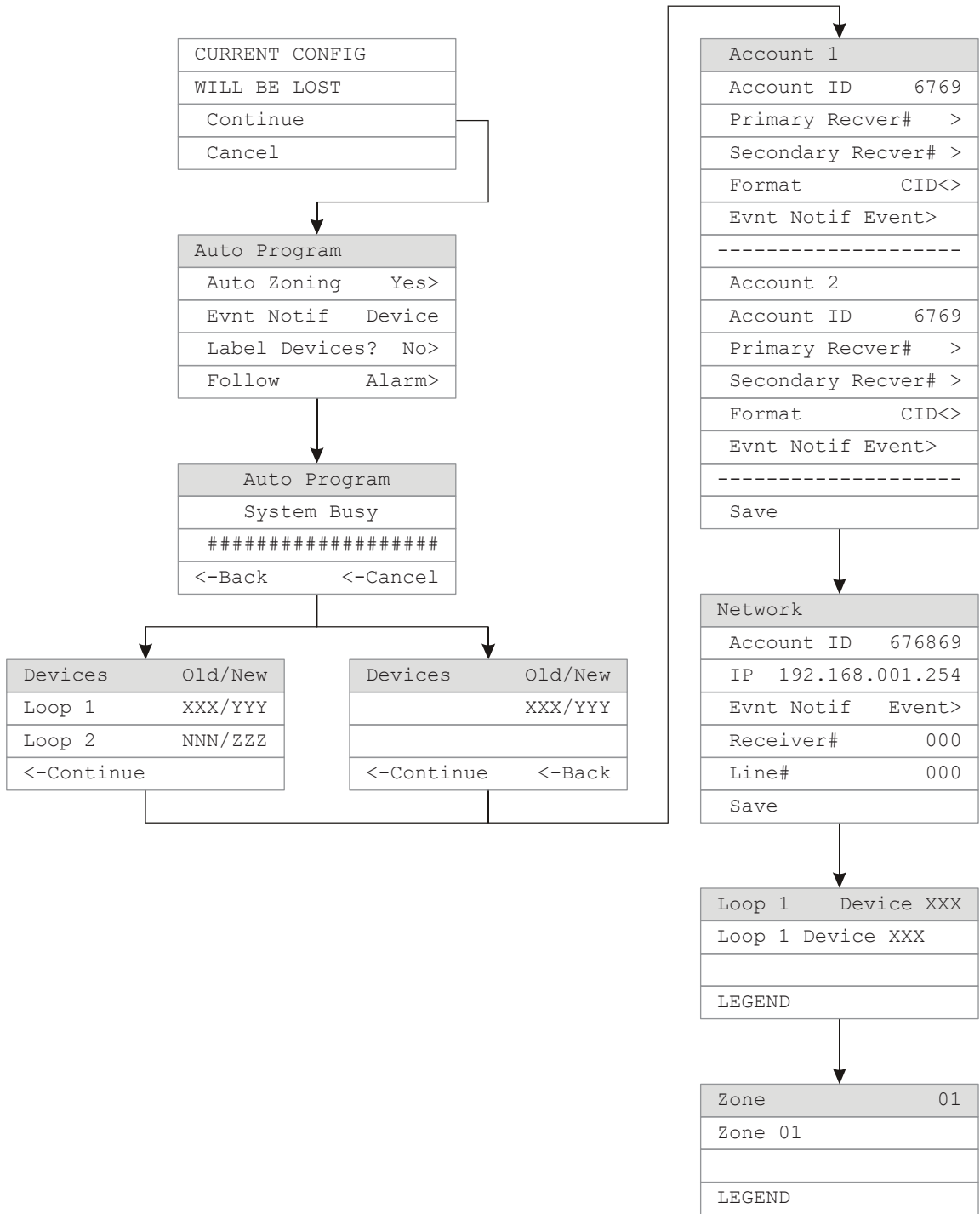

Incremental Program menu

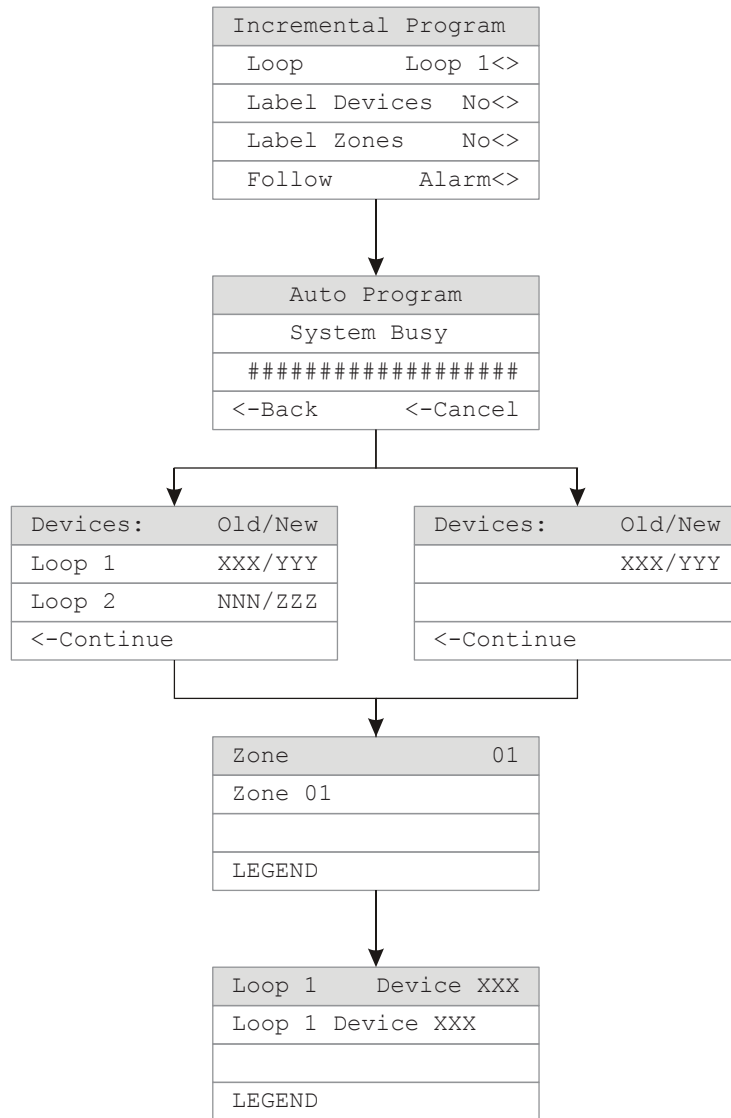

Diagnostics menu

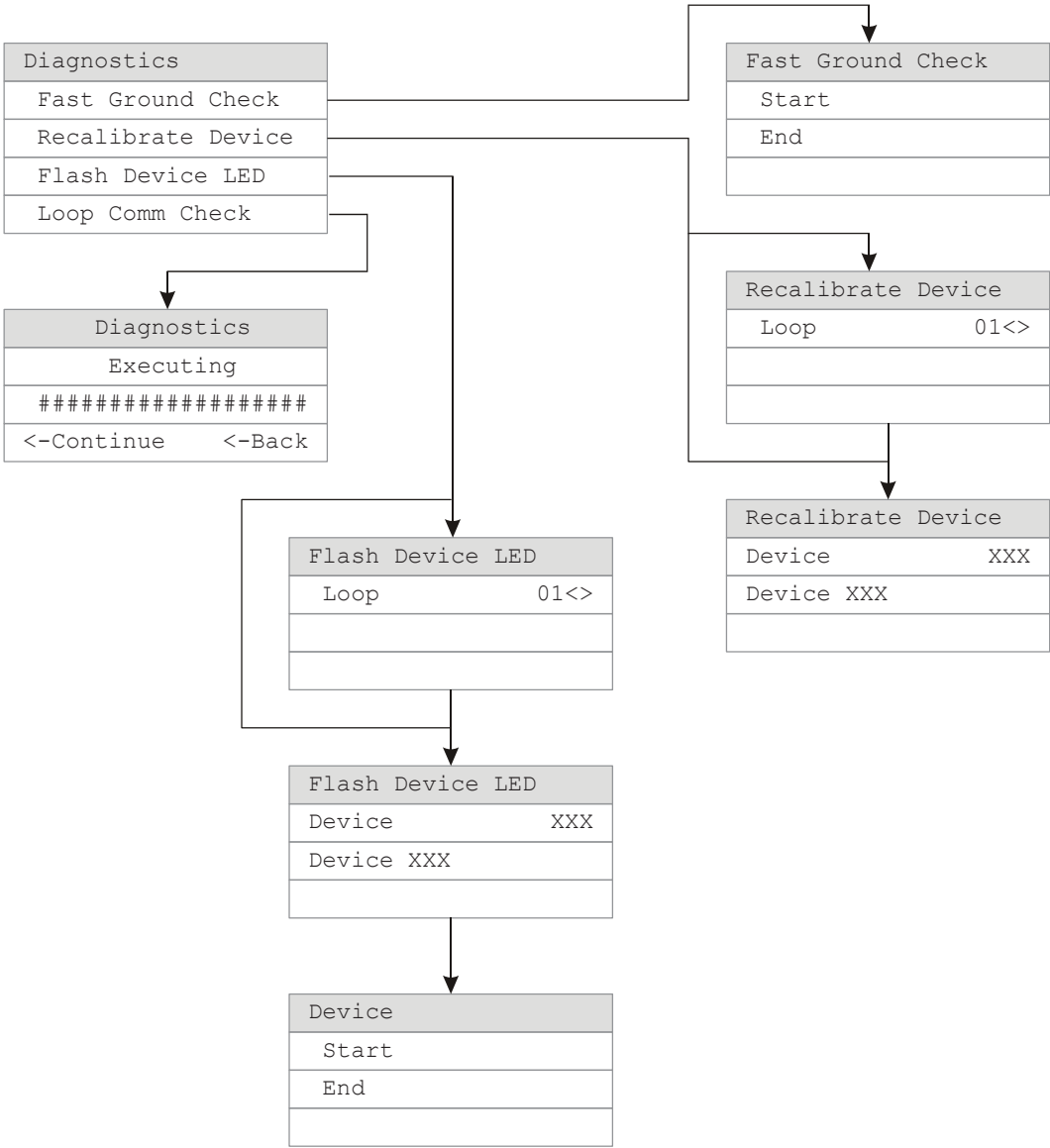

Appendix D

Applications

Summary

This appendix has sounder base applications that can be used with the SB4U sounder base.

Content

- Local alarm signaling applications 246
 - What is local alarm signaling? 246
 - Typical wiring for a local alarm signaling application 246
 - Programming sounder bases for a local alarm signaling application 247
- Correlated zone and system alarm signaling applications 247
 - Zone alarm signaling applications 247
 - System alarm signaling applications 250
- In-suite signal silence applications 252

Local alarm signaling applications

What is local alarm signaling?

In local alarm signaling applications, an audible detector base (sounder base) automatically sounds an alarm signal when its detector is activated. All other sounder bases on the same riser remain silent until their detectors are activated.

The sounder base continues to sound an alarm signal until smoke is cleared from its detector and the control panel is reset.

Typical wiring for a local alarm signaling application

Typically, the riser that supplies power to the sounder bases is supervised using an RM1 module. You can also use a CT1 module and a PAM-1 relay.

Figure 56: Typical wiring for a local alarm signaling application

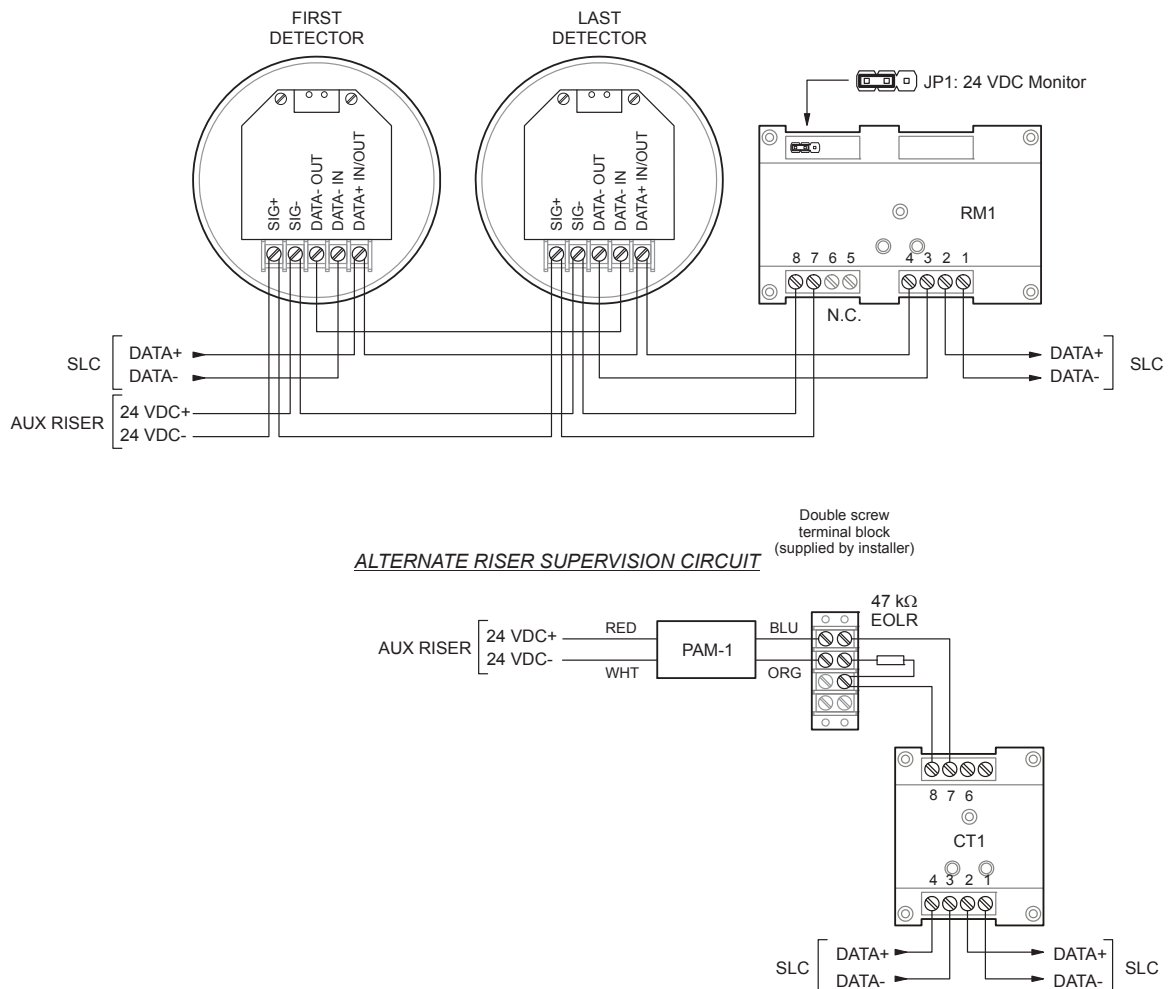

Programming sounder bases for a local alarm signaling application

1. Set the panel's Event Notification option to Device
2. Configure the smoke detectors as follows:
 - Device Type: Smoke or Smoke Heat depending on the detector model
 - Message Line 1: SMOKE_<N>, where <N> can be the device address or other number
 - Base Type: Sounder
 - Follow: Head
3. Configure the RM1 or CT1 module as follows:
 - Device type: Monitor
 - Message Line 1: 24VDC_RISER

Correlated zone and system alarm signaling applications

Correlated signaling applications are those in which sounder bases are triggered by associated correlation groups. This includes zone alarm and system alarm signaling applications. Detectors are added to the input side, and polarity reversal modules are added to the output side of one or more correlation groups.

Zone alarm signaling applications

What is zone alarm signaling?

In zone alarm signaling applications, detectors and sounder bases are grouped by zone. All sounder bases within a zone automatically sound alarm signals when any detector in the zone initiates an alarm event.

Since alarm signals are limited to the same notification zone, signal synchronization is not required. The sounder bases, once activated, continue to sound an alarm signal until:

- Smoke is cleared from the active detectors and the control panel is reset
- Signal Silence is pressed
- The control panel's Auto Signal Silence timer expires, if programmed. This can be from 5 to 30 minutes

- The in-suite signal silence timer expires, if programmed. (See “What is in-suite signal silence?” on page 33 and “Programming in-suite signal silence” on page 83.)

Typical wiring for zone alarm signaling

The following figure shows sounder base wiring for zone alarm signaling.

Figure 57: Typical wiring for a zone alarm signaling application

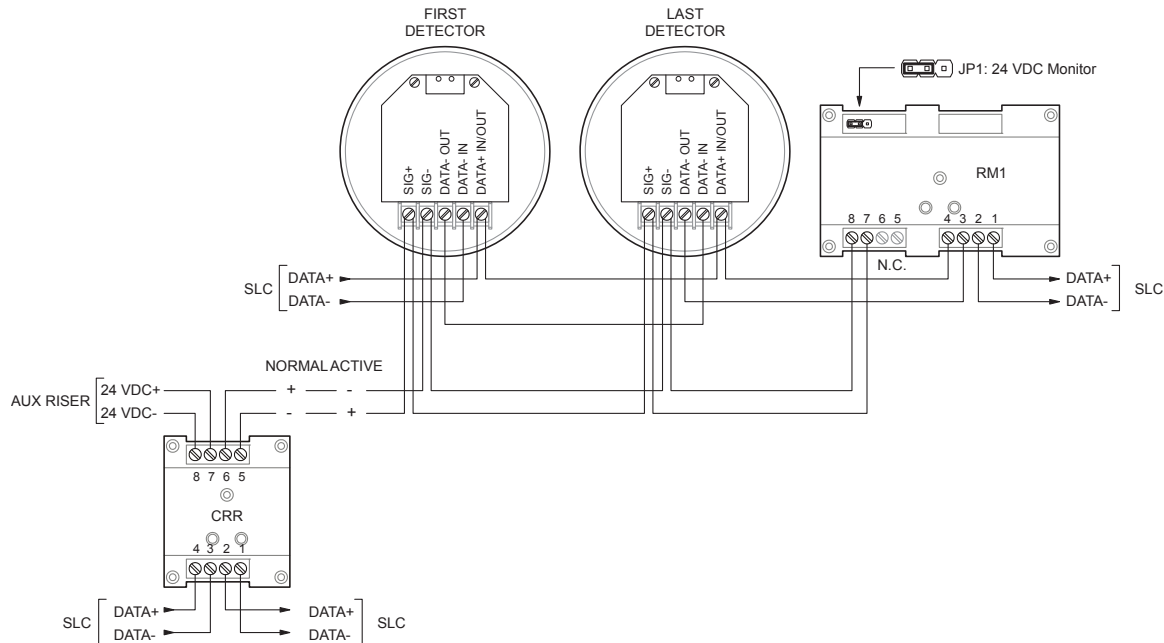

- A polarity reversal module can be used to provide power to the sounder bases. You can omit the polarity reversal module if correlation groups are used to activate the sounder bases.
- The RM1 module is used to monitor riser polarity. You can also use a CT1 module and a PAM-1 control relay for this purpose.

Programming for zone alarm signaling

This application requires that you group detectors into zones and correlate inputs and outputs for each zone. Zone alarm signaling is a type of correlated signaling: You can set up a zone alarm signaling application by creating correlation groups for specific zones. When using correlation groups, detectors are added to the input side, and polarity reversal modules are added to the output side of one or more correlation groups.

Note: The following instructions are written for “Zone 1” but can be applied to any zone.

To program a zone alarm signaling application:

1. Set the panel's Event Notification option to Zone.
2. Configure the smoke detectors in Zone 1 as follows:
 - Device Type: Smoke or Smoke Heat depending on the detector model
 - Message Line 1: SMOKE_<N>
 - Message Line 2: ZONE_01
 - Base Type: Sounder
 - Follow: None, Head, Alarm, Alm + Vrfy, or Alm + PreAlm

Note: If alarm verification is required, set Device Type for Smoke Verified, set Verification and Alt Verification as required, set Follow Verification for No, and set Follow Pre Alarm for Yes.
3. Configure the polarity reversal or CT1 module as follows:
 - Device Type: Relay Silence
 - Message Line 1: ZONE_1
 - Message Line 2: SOUNDERS

Note: The polarity reversal module can be omitted if correlation groups are used to activate the sounder bases.
4. Configure the RM1 or CT1 module as follows:
 - Device type: Monitor
 - Message Line 1: ZONE_1
 - Message Line 2: 24VDC_RISER
5. Configure Zone 01 as follows:
 - Inputs: All detectors in Zone 1
 - Outputs: The or polarity reversal or CT1 module labeled ZONE_1_SOUNDERS
 - Correlation Groups: 001
 - Status: Included

Note: For best performance, use the fast correlation groups for bulk activations, such as entire floors and save the slower correlation groups for small sets of activations like a suite or hotel room. See "Programming fast groups for sounder bases" on page 85.
6. Configure Correlation 001 as follows:

Inputs: Zone 1

Outputs: The polarity reversal or CT1 module labeled ZONE_1 SOUNDERS

System alarm signaling applications

What is system alarm signaling?

In system alarm signaling applications, all sounder bases sound when any alarm signal-initiating device is activated. Signal synchronization is required because alarm signals are not limited to the same notification zone.

The sounder bases, once activated, continue to sound an alarm signal until:

- Smoke is cleared from the active detectors and the control panel is reset
- Signal Silence is pressed
- The control panel's Auto Signal Silence timer expires, if programmed. This can be from 5 to 30 minutes
- The in-suite signal silence timer expires, if programmed. (See "What is in-suite signal silence?" on page 33 and "Programming in-suite signal silence" on page 83.)

Typical wiring for system alarm signaling applications

The figure below shows the typical wiring for synchronized system alarm signaling.

A is required to supply power to the sounder bases regardless of riser polarity. Typically, the 24 VDC riser that supplies power to the sounder bases is supervised using an RM1 Riser Monitor module. You can also use a CT1 module and a PAM-1 control relay for this purpose. In addition a G1M-RM is required for synchronization.

Figure 58: Typical wiring for a system alarm signaling application

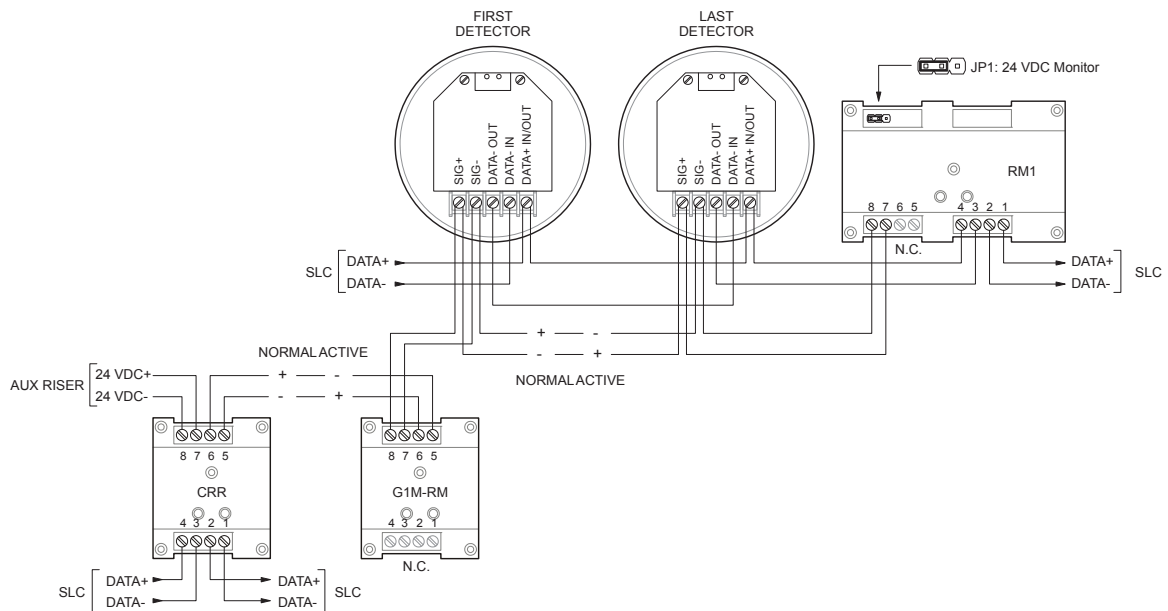

- A polarity reversal module can be used to provide power to the sounder bases. You can omit the polarity reversal module if correlation groups are used to activate the sounder bases.
- The RM1 module is used to monitor riser polarity. You can also use a CT1 module and a PAM-1 control relay for this purpose.
- The G1M-RM module is required to provide sounder synchronization.

Programming for system alarm signaling

1. Set the panel's Event Notification option to Device.
2. Configure the smoke detectors as follows:
 - Message Line 1: SMOKE_<N>
 - Base Type: Sounder
 - Follow: None, Head, Alarm, Alm + Vrfy, or Alm + PreAlm
3. Configure the polarity reversal module as follows:
 - Device Type: Relay Silence
 - Message Line 1: SOUNDER_RLY_1
 - Message Line 2: As required
4. Configure the RM1 or CT1 module as follows:
 - Device type: Monitor
 - Message Line 1: 24VDC_RISER
 - Message Line 2: SOUNDER_RLY_1
5. Configure Correlation Group 001 as follows:

Add/Remove Zone: As required

Add/Remove NAC: Add all polarity reversal modules used to activate sounder bases

Add/Remove Device: Add all alarm signal initiating devices

In-suite signal silence applications

This section provides high level instructions for creating an in-suite signal silence application based on the use of correlation groups. Additional background material and detailed instructions are also available. See:

- “What is in-suite signal silence?” on page 33
- “Programming in-suite signal silence” on page 83
- “What is a correlation group?” on page 32
- “Correlation group programming” on page 79

Figure 59: Audible signal circuit wiring for in-suite signal silence in a five-story building

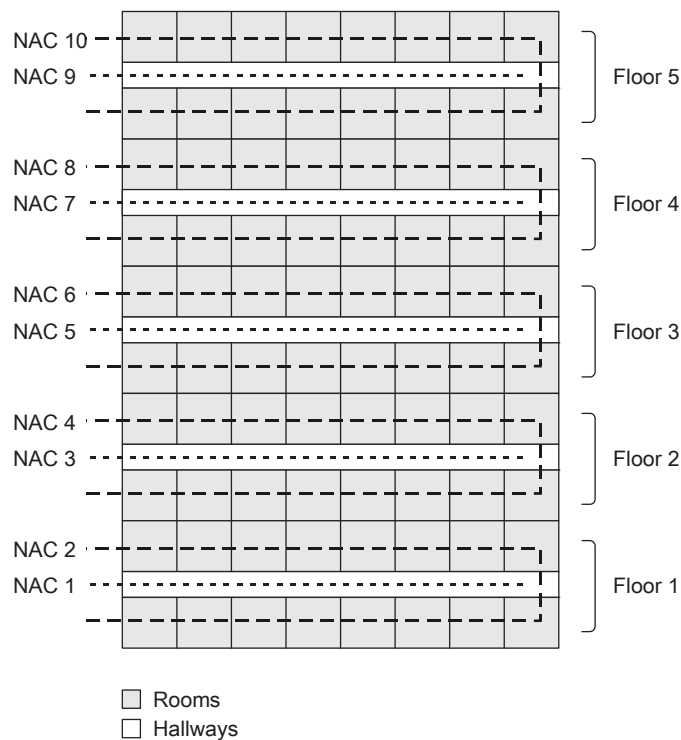

Figure 59 above illustrates in-suite signal silence wiring requirements in a sample residential occupancy building with five floors. The illustration shows the following:

- Separate audible signal circuits are provided for each floor.
- Audible signal circuits 2, 4, 6, 8, and 10 are located inside dwelling units.
- Audible signal circuits 1, 3, 5, 7, and 9 are located in hallways *not* within dwelling units.

To enable in-suite auto signal silence, you will need at least 'N+2' correlation groups, where N = the number of floor areas. You will need: A correlation group for each floor, a hallway correlation group, and an "in-suite" correlation group. The following tables show the inputs and outputs for these groups.

To create correlations for in suite signal silence, you'll follow these general steps:

1. Create a set of correlations for each floor.
2. Create a single hallway correlation to control hallway sounders on all floors.
3. Create a single in suite correlation for all floors to turn off sounders inside dwelling units on all floors except the floor of alarm.

Details of each step are described below.

Creating a set of correlations for each floor

Referring to the tables below, create a set of correlations — one for each floor. While the example given here is for a five-story building, you can adapt it to fit the number of separate floors (or other areas) in your application. Create one correlation for each floor (or area). These correlations ensure that if an alarm is detected on the floor, sounders located in dwelling units on the same floor will sound.

On each floor, link all input devices on the floor (both inside dwelling units and in hallways) to the sounders inside dwelling units on the same floor.

Notes:

- Set the alarm activation count for each floor correlation to 1.
- Do not enable in-suite signal silence.

Floor 1 Correlation

Input	Output	No in suite signal silence
Floor 1 dwelling and hallway inputs	Floor 1 dwelling and hallway audibles	

Floor 2 Correlation

Input	Output	No in suite signal silence
Floor 2 dwelling and hallway inputs	Floor 2 dwelling and hallway audibles	

Floor 3 Correlation

Input	Output	No in suite signal silence
Floor 3 dwelling and hallway inputs	Floor 3 dwelling and hallway audibles	

Floor 4 correlation

Input	Output	No in suite signal silence
Floor 4 dwelling and hallway inputs	Floor 4 dwelling and hallway audibles	

Floor 5 correlation

Input	Output	No in suite signal silence
Floor 5 dwelling and hallway inputs	Floor 5 dwelling and hallway audibles	

Creating a hallway correlation

The hallway correlation ensures that an alarm detected anywhere in the building will turn on all audibles located in hallways throughout the building.

On the input side of this correlation, add all input devices on all floors. Include all those inside dwelling units and all those in hallways.

On the output side, add all hallway sounders throughout the building.

Notes

- Set the alarm activation count for this correlation to 1.
- Do not enable in-suite signal silence.

Hallway Correlation

Input	Output
Occupant and hallway inputs on all floors	Hallway sounders on all floors

Creating an in-suite correlation group

The in-suite correlation is used to silence sounders inside dwelling units, except on the floor of alarm.

Create one in-suite correlation group. On the input side, add all input devices on all floors. Include those located inside dwelling units and those located in hallways.

On the output side, add all sounders located inside dwelling units on all floors.

Notes

- Set the alarm activation count for this correlation to 1.
- For this correlation only, enable in-suite signal silence.

In-Suite Signal Silence Correlation

Input	Output
Occupant and hallway inputs on all floors	Occupant sounders on all floors

How this application works

This application silences the audible alarm signals inside dwelling units, except on the floor of the alarm.

For example, if an alarm occurs on the third floor:

- The Floor 3 Correlation turns on the sounders on the floor of the alarm (including those inside dwelling units).
- The Hallway Correlation turns on hallway sounders throughout the building.
- The In-Suite Signal Silence Correlation turns on sounders in residences on all other floors.
- After 60 seconds, the In-Suite Signal Silence Correlation, which has in-suite signal silence enabled, silences sounders inside dwelling units on all other floors. These signals remain off until the in-suite signal silence timer expires or a subsequent alarm comes in.

Appendix E

Device types to personality codes correlation

Device types must be used when programming devices, but personality codes are described on the Signature Series installation sheets. This table correlates the different device types with their respective personality codes.

Table 51: Device types vs. personality codes

Model	Device type	Personality code
270	Pull Station	(1) Alarm - NO latching (Class B)
270B	Pull Station	(1) Alarm - NO latching (Class B)
270F	Pull Station	(1) Alarm - NO latching (Class B)
270P	Alarm (Ch2 only)	(1) Alarm - NO latching (Class B)
270P	Pull Station (Ch1 only)	(1) Alarm - NO latching (Class B)
270PB	Alarm (Ch2 only)	(1) Alarm - NO latching (Class B)
270PB	Pull Station (Ch1 only)	(1) Alarm - NO latching (Class B)
271	Pull Station	(1) Alarm - NO latching (Class B)
278	Pull Station	(1) Alarm - NO latching (Class B)
CC1	Continuous Non-Silenceable	(5) Signal - supervised output (Class B)
CC1	Continuous Non-Silenceable (Latched)	(5) Signal - supervised output (Class B)
CC1	Continuous Silenceable	(5) Signal - supervised output (Class B)
CC1	Supervised Output	(5) Signal - supervised output (Class B)
CC1	Supervised Output (Latched)	(5) Signal - supervised output (Class B)
CC1S	Continuous Non-Silenceable	(5) Signal - supervised output (Class B)
CC1S	Continuous Non-Silenceable (Latched)	(5) Signal - supervised output (Class B)

Model	Device type	Personality code
CC1S	Continuous Silenceable	(5) Signal - supervised output (Class B)
CC1S	Genesis Audible Visible Silence	(25) Signal - supervised auto sync output (Class B)
CC1S	Genesis Non-Silenceable	(25) Signal - supervised auto sync output (Class B)
CC1S	Supervised Output	(5) Signal - supervised output (Class B)
CC1S	Supervised Output (Latched)	(5) Signal - supervised output (Class B)
CC2	Continuous Non-Silenceable	(7) Riser Selector - supervised output (Class B)
CC2	Continuous Non-Silenceable (Latched)	(7) Riser Selector - supervised output (Class B)
CC2	Continuous Silenceable	(7) Riser Selector - supervised output (Class B)
CC2	Supervised Output	(7) Riser Selector - supervised output (Class B)
CC2	Supervised Output (Latched)	(7) Riser Selector - supervised output (Class B)
CR	Relay Non-Silenceable	(8) Signal - dry contact output
CR	Relay Non-Silenceable (Latched)	(8) Signal - dry contact output
CR	Relay Silence	(8) Signal - dry contact output
CR2	Relay Non-Silenceable	(8) Signal - dry contact output
CR2	Relay Non-Silenceable (Latched)	(8) Signal - dry contact output
CR2	Relay Silence	(8) Signal - dry contact output
CRR	Relay Non-Silenceable	(8) Signal - dry contact output
CRR	Relay Non-Silenceable (Latched)	(8) Signal - dry contact output
CRR	Relay Silence	(8) Signal - dry contact output
CT1	Alarm	(1) Alarm - NO latching (Class B)
CT1	Heat	(1) Alarm - NO latching (Class B)
CT1	Monitor	(3) Active - NO nonlatching (Class B)
CT1	Pull Station	(1) Alarm - NO latching (Class B)
CT1	Remote AC Fail	(3) Active - NO nonlatching (Class B)
CT1	Remote Drill	(3) Active - NO nonlatching (Class B)
CT1	Remote Reset	(3) Active - NO nonlatching (Class B)
CT1	Remote Signal Silence	(3) Active - NO nonlatching (Class B)
CT1	Smoke	(1) Alarm - NO latching (Class B)
CT1	Supervisory Latching	(4) Active - NO latching (Class B)
CT1	Supervisory Nonlatching	(3) Active - NO nonlatching (Class B)
CT1	Unlatch outputs	(3) Active - NO nonlatching (Class B)
CT1	Water Flow	(2) Alarm - NO delayed latching (Class B)
CT2	Alarm	(1) Alarm - NO latching (Class B)

Model	Device type	Personality code
CT2	Heat	(1) Alarm - NO latching (Class B)
CT2	Monitor	(3) Active - NO nonlatching (Class B)
CT2	Pull Station	(1) Alarm - NO latching (Class B)
CT2	Remote AC Fail	(3) Active - NO nonlatching (Class B)
CT2	Remote Drill	(3) Active - NO nonlatching (Class B)
CT2	Remote Reset	(3) Active - NO nonlatching (Class B)
CT2	Remote Signal Silence	(3) Active - NO nonlatching (Class B)
CT2	Smoke	(1) Alarm - NO latching (Class B)
CT2	Supervisory Latching	(4) Active - NO latching (Class B)
CT2	Supervisory Nonlatching	(3) Active - NO nonlatching (Class B)
CT2	Unlatch outputs	(3) Active - NO nonlatching (Class B)
CT2	Water Flow	(2) Alarm - NO delayed latching (Class B)
DTS	Duct Alarm	(1) Alarm - NO latching (Class B)
DTS	Duct Supervisory Latching	(4) Active - NO latching (Class B)
DTS	Duct Supervisory Nonlatching	(3) Active - NO nonlatching (Class B)
HFS	Heat	(1) Alarm - NO latching (Class B)
HRS	Heat ROR	(1) Alarm - NO latching (Class B)
IM	Monitor	(1) Alarm - NO latching (Class B)
IO	Relay Non-Silence NC	(32) Monitor - NO input/output NC
IO	Relay Non-Silence NC (Latched)	(32) Monitor - NO input/output NC
IO	Relay Non-Silence NO	(31) Monitor - NO input/output NO
IO	Relay Non-Silence NO (Latched)	(31) Monitor - NO input/output NO
IO	Relay Silence NC	(32) Monitor - NO input/output NC
IO	Relay Silence NO	(31) Monitor - NO input/output NO
IPHS	Smoke	(1) Alarm - NO latching (Class B)
IPHS	Smoke Verified	(1) Alarm - NO latching (Class B)
IPHS	Supervisory Latching	(1) Alarm - NO latching (Class B)
IPHS	Supervisory Nonlatching	(3) Active - NO nonlatching (Class B)
IS	Smoke	(1) Alarm - NO latching (Class B)
IS	Smoke Verified	(1) Alarm - NO latching (Class B)
MAB	2Wire Alarm	(13) Alarm - two-wire smoke unverified (Class B)
MAB	2Wire Alarm Class A	(20) Alarm - two-wire smoke unverified (Class A)
MAB	2Wire Alarm Verify	(14) Alarm - two-wire smoke verified (Class B)
MAB	2Wire Alarm Verify Class A	(21) Alarm - two-wire smoke verified (Class A)

Model	Device type	Personality code
MAB	Alarm	(1) Alarm - NO latching (Class B)
MAB	Alarm Class A	(9) Alarm - NO latching (Class A)
MAB	Continuous Non-Silenceable	(16) Signal - supervised output (Class B)
MAB	Continuous Non-Silenceable (Latched)	(16) Signal - supervised output (Class B)
MAB	Continuous Non-Silenceable Class A	(15) Signal - supervised output (Class A)
MAB	Continuous Non-Silenceable Class A (Latched)	(15) Signal - supervised output (Class A)
MAB	Continuous Silenceable	(16) Signal - supervised output (Class B)
MAB	Continuous Silenceable Class A	(15) Signal - supervised output (Class A)
MAB	Heat	(1) Alarm - NO latching (Class B)
MAB	Heat Class A	(9) Alarm - NO latching (Class A)
MAB	Monitor	(3) Active - NO nonlatching (Class B)
MAB	Monitor Class A	(11) Active - NO nonlatching (Class A)
MAB	None	(0) No Personality
MAB	Pull Station	(1) Alarm - NO latching (Class B)
MAB	Pull Station Class A	(9) Alarm - NO latching (Class A)
MAB	Remote AC Fail	(3) Active - NO nonlatching (Class B)
MAB	Remote AC Fail Class A	(11) Active - NO nonlatching (Class A)
MAB	Remote Drill	(3) Active - NO nonlatching (Class B)
MAB	Remote Reset	(3) Active - NO nonlatching (Class B)
MAB	Remote Signal Silence	(3) Active - NO nonlatching (Class B)
MAB	Smoke	(1) Alarm - NO latching (Class B)
MAB	Smoke Class A	(9) Alarm - NO latching (Class A)
MAB	Supervised Output	(16) Signal - supervised output (Class B)
MAB	Supervised Output (Latched)	(16) Signal - supervised output (Class B)
MAB	Supervised Output Class A	(15) Signal - supervised output (Class A)
MAB	Supervised Output Class A (Latched)	(15) Signal - supervised output (Class A)
MAB	Supervisory Latching	(4) Active - NO latching (Class B)
MAB	Supervisory Latching Class A	(12) Active - NO latching (Class A)
MAB	Supervisory Nonlatching	(3) Active - NO nonlatching (Class B)
MAB	Supervisory Nonlatching Class A	(11) Active - NO nonlatching (Class A)
MAB	Water Flow	(2) Alarm - NO delayed latching (Class B)

Model	Device type	Personality code
MAB	Water Flow Class A	(10) Alarm - NO delayed latching (Class A)
MCC1	Continuous Non-Silenceable	(5) Signal - supervised output (Class B)
MCC1	Continuous Non-Silenceable (Latched)	(5) Signal - supervised output (Class B)
MCC1	Continuous Silenceable	(5) Signal - supervised output (Class B)
MCC1	Supervised Output	(5) Signal - supervised output (Class B)
MCC1	Supervised Output (Latched)	(5) Signal - supervised output (Class B)
MCC1S	Continuous Non-Silenceable	(5) Signal - supervised output (Class B)
MCC1S	Continuous Non-Silenceable (Latched)	(5) Signal - supervised output (Class B)
MCC1S	Continuous Silenceable	(5) Signal - supervised output (Class B)
MCC1S	Genesis Audible Visible Silence	(25) Signal - supervised auto sync output (Class B)
MCC1S	Genesis Non-Silenceable	(25) Signal - supervised auto sync output (Class B)
MCC1S	Supervised Output	(5) Signal - supervised output (Class B)
MCC1S	Supervised Output (Latched)	(5) Signal - supervised output (Class B)
MCC2	Continuous Non-Silenceable	(7) Riser Selector - supervised output (Class B)
MCC2	Continuous Non-Silenceable (Latched)	(7) Riser Selector - supervised output (Class B)
MCC2	Continuous Silenceable	(7) Riser Selector - supervised output (Class B)
MCC2	Supervised Output	(7) Riser Selector - supervised output (Class B)
MCC2	Supervised Output (Latched)	(7) Riser Selector - supervised output (Class B)
MCR	Relay Non-Silenceable	(8) Signal - dry contact output
MCR	Relay Non-Silenceable (Latched)	(8) Signal - dry contact output
MCR	Relay Silence	(8) Signal - dry contact output
MCRR	Relay Non-Silenceable	(8) Signal - dry contact output
MCRR	Relay Non-Silenceable (Latched)	(8) Signal - dry contact output
MCRR	Relay Silence	(8) Signal - dry contact output
MCT2	Alarm	(1) Alarm - NO latching (Class B)
MCT2	Heat	(1) Alarm - NO latching (Class B)
MCT2	Monitor	(3) Active - NO nonlatching (Class B)
MCT2	Pull Station	(1) Alarm - NO latching (Class B)
MCT2	Remote AC Fail	(3) Active - NO nonlatching (Class B)
MCT2	Remote Drill	(3) Active - NO nonlatching (Class B)
MCT2	Remote Reset	(3) Active - NO nonlatching (Class B)
MCT2	Remote Signal Silence	(3) Active - NO nonlatching (Class B)

Model	Device type	Personality code
MCT2	Smoke	(1) Alarm - NO latching (Class B)
MCT2	Supervisory Latching	(4) Active - NO latching (Class B)
MCT2	Supervisory Nonlatching	(3) Active - NO nonlatching (Class B)
MCT2	Unlatch Outputs	(3) Active - NO nonlatching (Class B)
MCT2	Water Flow	(2) Alarm - NO delayed latching (Class B)
MIO	Relay Non-Silence NC	(32) Monitor - NO input/output NC
MIO	Relay Non-Silence NC (Latched)	(32) Monitor - NO input/output NC
MIO	Relay Non-Silence NO	(31) Monitor - NO input/output NO
MIO	Relay Non-Silence NO (Latched)	(31) Monitor - NO input/output NO
MIO	Relay Silence NC	(32) Monitor - NO input/output NC
MIO	Relay Silence NO	(32) Monitor - NO input/output NC
MM1	Monitor	(3) Active - NO nonlatching (Class B)
MM1	Unlatch Outputs	(3) Active - NO nonlatching (Class B)
MRM1	Monitor	(23) Riser monitor - 24 VDC
PHS	Smoke Heat	(1) Alarm - NO latching (Class B)
PHS	Smoke Verified	(1) Alarm - NO latching (Class B)
PHS	Supervisory Latching	(1) Alarm - NO latching (Class B)
PHS	Supervisory Nonlatching	(3) Active - NO nonlatching (Class B)
PS	Smoke	(1) Alarm - NO latching (Class B)
PS	Smoke Verified	(1) Alarm - NO latching (Class B)
PS	Supervisory Latching	(1) Alarm - NO latching (Class B)
PS	Supervisory Nonlatching	(3) Active - NO nonlatching (Class B)
RM1	Monitor	(23) Riser monitor - 24 VDC
SD	Duct Alarm	(1) Alarm - NO latching (Class B)
SD	Duct Supervisory Latching	(4) Active - NO latching (Class B)
SD	Duct Supervisory Nonlatching	(3) Active - NO nonlatching (Class B)
UM	2Wire Alarm	(13) Alarm - two-wire smoke unverified (Class B)
UM	2Wire Alarm Class A	(20) Alarm - two-wire smoke unverified (Class A)
UM	2Wire Alarm Verify	(14) Alarm - two-wire smoke verified (Class B)
UM	2Wire Alarm Verify Class A	(21) Alarm - two-wire smoke verified (Class A)
UM	Alarm	(1) Alarm - NO latching (Class B)
UM	Alarm Class A	(9) Alarm - NO latching (Class A)
UM	Continuous Non-Silenceable	(16) Signal - supervised output (Class B)

Model	Device type	Personality code
UM	Continuous Non-Silenceable (Latched)	(16) Signal - supervised output (Class B)
UM	Continuous Non-Silenceable Class A	(15) Signal - supervised output (Class A)
UM	Continuous Non-Silenceable Class A (Latched)	(15) Signal - supervised output (Class A)
UM	Continuous Silenceable	(16) Signal - supervised output (Class B)
UM	Continuous Silenceable Class A	(15) Signal - supervised output (Class A)
UM	Heat	(1) Alarm - NO latching (Class B)
UM	Heat Class A	(9) Alarm - NO latching (Class A)
UM	Monitor	(3) Active - NO nonlatching (Class B)
UM	Monitor Class A	(11) Active - NO nonlatching (Class A)
UM	None	(0) No Personality
UM	Pull Station	(1) Alarm - NO latching (Class B)
UM	Pull Station Class A	(9) Alarm - NO latching (Class A)
UM	Relay Non-Silenceable	(8) Signal - dry contact output
UM	Relay Non-Silenceable (Latched)	(8) Signal - dry contact output
UM	Relay Silence	(8) Signal - dry contact output
UM	Remote AC Fail	(3) Active - NO nonlatching (Class B)
UM	Remote AC Fail Class A	(11) Active - NO nonlatching (Class A)
UM	Remote Drill	(3) Active - NO nonlatching (Class B)
UM	Remote Reset	(3) Active - NO nonlatching (Class B)
UM	Remote Signal Silence	(3) Active - NO nonlatching (Class B)
UM	Smoke	(1) Alarm - NO latching (Class B)
UM	Smoke Class A	(9) Alarm - NO latching (Class A)
UM	Supervised Output	(16) Signal - supervised output (Class B)
UM	Supervised Output (Latched)	(16) Signal - supervised output (Class B)
UM	Supervised Output Class A	(15) Signal - supervised output (Class A)
UM	Supervised Output Class A (Latched)	(15) Signal - supervised output (Class A)
UM	Supervisory Latching	(4) Active - NO latching (Class B)
UM	Supervisory Latching Class A	(12) Active - NO latching (Class A)
UM	Supervisory Nonlatching	(3) Active - NO nonlatching (Class B)
UM	Supervisory Nonlatching Class A	(11) Active - NO nonlatching (Class A)
UM	Unlatch Outputs	(3) Active - NO nonlatching (Class B)

Model	Device type	Personality code
UM	Water Flow	(2) Alarm - NO delayed latching (Class B)
UM	Water Flow Class A	(10) Alarm - NO delayed latching (Class A)
WTM	Water Flow (Ch1 only)	(2) Alarm - NO delayed latching (Class B)
WTM	Supervisory Latching (Ch2 only)	(4) Active - NO latching (Class B)
WTM	Supervisory Nonlatching (Ch2 only)	(3) Active - NO nonlatching (Class B)

Index

#

symbol, 140

*

* symbol, 140

,

, in text, 140

A

AC fail delay, 31, 35, 117
AC power, 117, 136, 146
AC power wiring, 5, 143
AC voltage, 5, 35, 117
account ID, 35, 56, 110
ACK/panel silence, 152
ACK/panel silence button, 138, 139
activate, 146, 154, 156
activating a device, 154
activating a NAC, 156
active points, 132
add device, 32, 67
advanced program menu, 231
advanced programming, 32, 76, 78
alarm, 13, 125
alarm contact, 192
alarm device, 190
alarm event, 144, 146
alarm history report, 168
alarm LED, 136
alarm relay wiring, 13
alphanumeric keypad, 138, 139
annunciator, 14, 107, 143
annunciator buzzer, 152
annunciator class, 35, 106
annunciator event, 132
annunciator specifications, 14
annunciator trouble, 146
annunciator type, 35

arrow buttons, 138
auto program menu, 241
auto programming, 32, 56
auto signal silence, 35, 117, 152
auto zoning, 56
aux power, 146
aux power reset, 35
auxiliary current, 192
auxiliary fire alarm system, viii
auxiliary/smoke power output wiring, 16
auxiliary/smoke power specifications, 16

B

backlight, 132
banner screen, 117, 132
base follow, 35, 56, 64, 67, 87
base type, 67
batteries, 7, 143, 192
battery calculation worksheet, 196
battery charger, 146
battery low, 146
battery missing, 146
battery specifications, 192
battery wiring, 7
buttons, 138, 139

C

cabinet, 2
cabinet box, 3
cabinet wire routing, 4
call disconnect, 35, 110
callback, 35, 110
cancel button, 138
Cancel button, 140
central station, viii
CID, 56, 110
CID codes, 39, 120, 122
circuit board, 3
city tie NACs, 138, 163
Class A, 8, 11, 14, 22, 98

- Class A card, 143
 - Class B, 8, 11, 14, 98
 - cleaning detector, 181
 - clear history, 146
 - CMS device, 108, 163
 - CMS device menu, 236
 - coder, 104
 - comm retries report, 176
 - comma button, 138, 139
 - comma, inserting, 140
 - common alarm relay, 13, 138
 - common supervisory relay, 13
 - common trouble, 126, 146
 - common trouble menu, 240
 - common trouble relay, 13
 - communication check, 181
 - communication fault, 76, 146, 181
 - component descriptions, 143
 - configuration utility, 55, 116
 - contact ID codes, 39, 120, 122
 - continuous, 104
 - control buttons, 32, 51, 138
 - control panel specifications, 192
 - control panel testing, 183
 - correlation group
 - fast group, 85
 - sounder base detectors in, 85
 - what is, 32
 - correlation groups, 35, 67, 87, 104, 126
 - programming, 79
 - correlation groups report, 172
 - correlation groups worksheet, 212
 - CTM module wiring, 25
 - cut duration, 31
 - cut duration/supervision, 110
- D**
- D16L-VS LED, 137
 - DACR, 24
 - date, 46, 132, 146
 - date format, 35, 117
 - date forward history report, 168
 - day prealarm, 35, 67
 - day sensitivity, 35, 67, 87
 - day start, 35, 117
 - daylight savings time, 35, 47
 - default programming options, 49
 - default settings, 35, 49
 - deleting device, 76
 - detector cleaning, 181
 - device
 - adding, 32, 67
 - deleting, 76
 - device 000, 146
 - device activating, 154
 - device communication, 176
 - device config menu, 234
 - device correlation groups, 79, 87
 - device count, 175
 - device details, 67, 76
 - accessing, 132
 - device details report, 175
 - device disable, 156
 - device enable, 156
 - device label, 56, 64, 87, 132
 - device loop, 98, 192
 - device loop card LEDs, 11
 - device loop maximum wire length, 206
 - device loop specifications, 11, 192
 - device loop wiring, 11
 - device maintenance report, 170
 - device mapping, 99
 - device number, 132
 - device polling, 176
 - device programming, 32, 67, 87
 - device report, 173
 - device reporting, 110, 112, 117
 - device restoring, 154
 - device settings worksheet, 213
 - device testing, 164, 184, 186
 - device type, 35, 67, 87
 - device types, 257
 - diagnostics
 - fast ground check, 180
 - loop comm check, 181
 - recalibrate device, 181
 - diagnostics menu, 243
 - diagnostics report, 176
 - dialer, 18, 56, 108, 110
 - dialer abnormal test, 146
 - dialer configuration, 56, 110, 146
 - dialer configuration report, 173
 - dialer deliver fail, 146
 - dialer disable, 163
 - dialer enable, 163
 - dialer line 01 and 02, 18, 110, 143
 - dialer line fault, 146
 - dialer mode, 31
 - dialer normal test, 146
 - dialer phone line wiring, 18
 - dialer testing, 184
 - dialer type, 35, 110
 - dirty percentage, 170
 - disable a device, 156
 - disable a zone, 158
 - disable dialer, 163
 - disable event, 144, 159

- disable LED, 136, 156, 162
- disable mapping, 99
- disable NAC, 162
- disable network card, 163
- disabled points, 132, 156
- disabling loop events, 160
- down arrow button, 138, 139
- downloading, 55
- drill, 146, 163
- drill button, 138
- dual line, 110

E

- electronics, 3
- enable a device, 156
- enable a zone, 158
- enable dialer, 163
- enable event, 159
- enable mapping, 99
- enable network card, 163
- enabling a NAC, 162
- enabling loop events, 160
- enclosure, 2, 143
- enter button, 138, 139
- Enter button, 140
- Ethernet, 116
- ethernet card, 24
- ethernet wiring, 24
- event codes, 39, 120, 122
- event configuration report, 173
- event descriptions, 146
- event details, 132, 151
- event disable, 159
- event enable, 159
- event ID numbers, 146
- event messages, 144
- event notification, 35, 56, 87, 104, 112, 114, 117, 120, 122, 126
- event printing, 144
- event reporting, 110, 112
- event type, 132
- events, 54, 120, 122, 144
- expanders, 35, 107

F

- factory defaults, 35
- fast ground check, 180
- fast group, 85
- fire drill, 163
- firmware revision, 173
- follow, 35, 56, 64, 67, 87
- front panel display, 131

- fst grp, 85

G

- gateway, 35, 116
- Genesis, 104
- ground fault, 146, 180
- ground fault LED, 136
- ground wire, 5, 6, 143

H

- hello time seconds, 35, 112
- history, 54
- history report, 168
- HyperTerminal, 188

I

- ID numbers, 146
- incremental programming, 32, 64
- incremental programming menu, 242
- installation, ix, 2
 - cabinet box, 2
 - panel electronics, 3
- internal event, 132
- internal fault, 146
- internal fault report, 177
- internal status report, 174
- IP address, 35, 112, 116
- isolators, 11, 192

K

- key #1, 35, 51
- key #2, 35, 51
- keypad, 138, 139

L

- labels, 67, 132
 - annunciator, 107
 - device, 87
 - NAC, 104
- lamp test, 154, 185
- lamp test button, 138
- language, 35, 117
- latched output
 - restoring, 155
- LCD banner, 35, 117
- LCD display, 107, 131, 132, 144
- LEDs, 11, 24, 131, 136
- left arrow button, 138, 139
- level 1 password, 32
- level 2 password, 32

line number, 35, 112
 lock remote read, 35, 116
 loop 2 enable, 35, 98
 loop card fault, 146
 loop card LEDs, 11
 loop circuit, 11, 78, 98, 122, 192
 loop class, 35, 98
 loop comm check, 181
 loop config menu, 232
 loop configuration options, 35, 78, 79, 87, 98, 99
 loop device 000, 146
 loop events, 122, 146, 160
 loop events disabling, 160
 loop events enabling, 160
 loop events menu, 239
 loop expander card, 143
 loop fault, 122, 146
 loop initialization, 146
 loop map fault, 146
 loop map mismatch, 146
 loop mapping, 146
 loop over limits, 146
 loop uncfgrd alarm, 146
 loop uncfgrd trouble, 146
 loop-zone configuration report, 173
 low voltage wiring, 6

M

main circuit board, 143
 mains supply, 5, 117
 maintenance schedule, 180
 map, 99
 map fault, 122
 map mismatch, 99, 146
 mapping, 99, 117, 146
 mapping disable, 99
 mapping enable, 99
 marketplace, 35, 117
 mask, 116
 menu button, 138, 139
 modem, 110

N

NAC, 51, 162, 192
 NAC activating, 156
 NAC disable, 162
 NAC enable, 162
 NAC label, 104
 NAC programming, 104
 NAC restoring, 156
 NAC silencing, 152
 NAC trouble, 146

NAC type, 104
 NAC wiring, 8, 22
 net recvr comm fault, 146
 net recvr config fault, 146
 network, 35, 56, 108, 112
 network cable, 24
 network card, 24, 116
 network card disable, 163
 network wiring, 24
 night prealarm, 35, 67
 night sensitivity, 35, 67, 87
 night start, 35, 117
 nonpower-limited wiring, 4
 notification appliance circuit, 162, 192
 notification appliance circuit maximum wire
 length calculation worksheet, 199
 notification appliance circuit wiring, 8
 notification appliance voltage drop calculation
 worksheet, 205
 notification appliances, 152
 number expanders, 35, 107

O

off normal events, 132
 operating voltage, 192
 operation overview, 131

P

panel buzzer, 151, 152
 panel config menu, 235
 panel configuration options, 35, 103, 104, 106,
 107, 108, 110, 112, 114, 116
 panel configuration report, 173
 panel configuration worksheet, 216
 panel defaults, 35
 panel electronics, 3
 panel events, 120, 144, 146, 159
 panel events menu, 238
 panel NAC, 8, 22, 35, 51, 162
 panel operation menu, 237
 panel operation options, 35, 117, 131
 panel operation report, 173
 panel operations worksheet, 219
 panel reset, 151
 panel restart, 55
 panel silence, 146, 152
 panel silence button, 138
 passwords, 32, 49
 PC wiring, 20
 personality codes, 257
 phone lines, 18
 ping, 116

- power LED, 136
- power-limited wiring, 4
- prealarm, 87
- preventive maintenance schedule, 180
- primary receiver number, 56, 110
- printed events, 144
- printer, 114, 144
- printer card, 143
- printer trouble, 146
- printer type, 35
- printer wiring, 20
- program menu, 229
- program mode, 146
- programmable keys, 51
- programmable keys menu, 230
- programming, ix, 32, 56, 64, 77
 - control buttons, 32
 - correlation groups, 79
- programming defaults, 35, 49
- programming mode, 32
- programming requirements, 31
- protected premises fire alarm system, viii
- pseudo points, 146

Q

- quality percent, 176

R

- recalibrate device, 181
- receiver number, 35, 112
- receivers, 24
- redundant Class B, 22
- relay specifications, 13, 192
- remote annunciator, 14, 107, 192
- remote annunciator wiring, 22
- remote communications, 116
- remote disconnect, 163
- remote disconnect button, 138
- Remote disconnect button, 138
- remote disconnect LED, 136
- remote supervising station, viii
- removing device, 76
- replacing a device in alarm, 190
- reports, 168, 178
 - cancel, 178
 - correlation groups, 172
 - device details, 175
 - device maintenance, 170
 - history, 168
 - internal status, 174
 - system configuration, 173
 - system status, 171

- walk test, 170
 - zone, 173
- reports/diagnostics, 176
- reports/internal fault, 177
- reset, 146, 151
- reset button, 138
- reset inhibit, 35, 117
- response quality report, 176
- restart, 55, 116
- restore, 146, 154, 156
- restore codes, 31
- restoring a device, 154
- restoring a latched output, 155
- restoring a NAC, 156
- retry count, 110
- retry time, 110
- revision, 173
- right arrow button, 138, 139
- ring type, 35, 110
- rings to answer, 35, 110
- RPM module wiring, 26
- RS-232, 20, 188
- RS232 CU Enable, 35, 55

S

- SA-232 wiring, 20
- SA-CLA wiring, 22
- SA-DACT, 18, 184
- SA-DACT specifications, 18, 192
- SA-ETH LEDs, 24
- SA-ETH wiring, 24
- SB4U, 246
- secondary receiver number, 56, 110
- self test fault, 146
- semi-flush mount, 2
- send restorals, 35, 110, 112
- sensitivity, 87
- sensitivity report, 170
- serial numbers, 175
- signal silence, 146, 152
- signal silence button, 138
- signal silence LED, 136
- silencing annunciator buzzer, 152
- silencing notification appliances, 152
- silencing panel buzzer, 152
- single line, 110
- sounder base, 246
- Sounder base detectors
 - fast groups, 85
- space between words or characters, 140
- specifications
 - auxiliary/smoke power, 16
 - batteries, 192

- control panel, 192
- device loop, 192
- NAC, 8
- relays, 13, 192
- remote annunciator, 14, 192
- SA-DACT, 18
- subnet mask, 35, 116
- supervisory, 13
- supervisory contact, 192
- supervisory event, 144, 146
- supervisory LED, 136
- supervisory relay wiring, 13
- surface mount, 2
- swinger shutdown, 35, 108
- system AC power, 146
- system configuration report, 173
- system events, 144, 151
- system LEDs, 131
- system requirements, viii
- system status report, 171

T

- TB1, 6
- TB2, 8
- TB3, 13, 16
- TB4, 14
- TB6, 8
- TB8, 7
- TCP/IP communications, 116
- TCP/IP port, 35, 112
- telephone supervision, 31
- telnet, 116
- temporal, 104
- test, 144
- test fire, 146, 184
- test frequency, 35
- test LED, 136
- test signal frequency, 31
- test time, 35
- testing, 183
- testing device, 184
- testing dialer, 184
- tie wrap mounts, 143
- time, 46, 47, 132, 146
- time and date, 46
- timeout seconds, 35, 112
- tone wait, 35, 110
- transformer, 143
- trouble, 13, 126, 144
- trouble contact, 192
- trouble event, 146
- trouble LED, 136, 151, 156, 162
- trouble relay wiring, 13

U

- UL 864, 31
- ULC testing, 183
- unconfigured alarm, 125
- unconfigured alarm menu, 240
- unprogrammed device, 67
- up arrow button, 138, 139
- uploading, 55
- user defined keys, 51

W

- walk test, 164, 186
- walk test report, 170
- waterflow, 56
- wire length calculation, 199, 206
- wire routing, 4
- wiring, ix
 - AC power, 5
 - alarm, 13
 - auxiliary/smoke power output, 16
 - batteries, 7
 - CTM module, 25
 - device loop wiring, 11
 - dialer phone lines, 18
 - notification appliance circuit, 8
 - remote annunciator, 14
 - RPM module, 26
 - supervisory, 13
 - trouble, 13
- worksheets
 - battery calculation, 196
 - correlation groups, 212
 - device loop maximum wire length, 206
 - device settings, 213
 - loop, 215
 - notification appliance circuit maximum wire length calculation, 199
 - notification appliance voltage drop calculation, 205
 - panel configuration worksheet, 216
 - panel operations, 219
 - zone settings, 220

Z

- Zone
 - description of, 32
- zone correlation groups, 79, 101
- zone disable, 158
- zone enable, 158
- zone event, 132
- zone label, 56, 64, 101
- zone programming, 67, 101

zone report, 173
zone reporting, 110, 112, 117
zone resound, 35, 117
zone settings worksheet, 220
zone testing, 164, 186
zone type, 35, 101
zone/device reporting, 117
zones, 51, 101, 192

