



xplorer

Optical Smoke Detector

Heat Detector

Manual Call Point

Output Unit

Isolator

The XPlorer Range

XPlorer is a new range of analogue addressable detectors and interfaces developed for all who want to access the benefits of analogue systems without having to commit to complex design and commissioning.

The XPlorer range comprises an optical smoke detector, two heat detectors and a manual call point. Two mounting bases are available for the detectors: a standard base and a remote LED driver base which is used if it is desired to connect a remote indicator LED. Detectors are supplied with either the standard or the LED driver base. An isolator is available to prevent the loss of entire loops in the event of a short circuit. An Output Unit is provided to switch external equipment.





Apollo Fire Detectors Limited, part of the Halma plc group of companies, operates from one site at Havant, near Portsmouth, England. All departments—Research and Development, Sales & Marketing, Operations and Finance—are located there. Apollo applies the most modern production techniques and has invested in sophisticated manufacturing equipment to ensure consistent high quality of product and fast response to customer requirements.



Key features

- **Complete product range**
- **Proven digital protocol**
- **Simple system design**
- **Simple ordering**
- **Full LPCB approval**

Information in this guide is given in good faith, but Apollo Fire Detectors Limited cannot be held responsible for any omissions or errors. The company reserves the right to change specifications of products at any time without prior notice.

	Features of the Xplorer Range	2
	Application of Xplorer Detectors	2
	Addressing and Communications	2
	Optical Smoke Detector	
	Operating principles	3
	Electrical description	3
	Environmental characteristics	4
	Technical data	4
	Heat Detector	
	Operating principles	5
	Electrical description	5
	Environmental characteristics	5
	Technical data	6
	Manual Call Point	
	Operating principles	7
	Technical data	7
	Output Unit	
	Operating principles	8
	Electrical considerations	8
	Protocol bit usage	8
	Mechanical construction	8
	Technical data	8
	Isolator	
	Operating principles	9
	Electrical description	9
	Technical data	9
	Xplorer Mounting Bases and XPERT cards	9
	Maintenance of detectors	9
	Approvals	9



xplorer

Features of the XPlorer Range

Entry level system:

63 detector addresses and 63 interface addresses.

Robust Protocol:

Digital protocol for error-free transmission

Control Unit Interrogation and Command:

3 bits of command instruction and the 7-bit address are issued by the control equipment following an initiating pulse.

Interrupt Warning:

Notification that an XPlorer manual call point has been operated.

Analogue Value Report:

Smoke or heat level continually reported.

Input Bits Reporting:

XPlorer smoke and heat detectors confirm compliance with the output command bits.

Automatic Type Identification:

The device being interrogated reports what type of device it is.

Address Confirmation:

The 6-bit address of the detector or interface responding is confirmed back to the control unit.

XPERT Card Addressing:

For fast reliable installation and service.

Unobtrusive Design:

For elegant designs in modern buildings.

Application of XPlorer Detectors

The choice of detector from the XPlorer range follows the well established principles of system design. That is, the optimum detector type will depend on the type of fire risk and fire load, and the type of environment in which the detector is sited.

For general use, smoke detectors are recommended since these give the highest level of protection. Where the environment is smoky or dirty under normal conditions, a heat detector may be more appropriate. It must be recognised, however, that any heat detector will respond only when the fire is well established and generating a high heat output.

Addressing and Communications

Each XPlorer device responds to interrogation and command from central control equipment. It communicates information on status, command bits, type and location to the control panel.

A unique, patented XPERT card provides simple, user friendly and accurate identification of detector location whereby a coded card, inserted in the base, is read by any detector once it is plugged in. All the electronic components are in the detector but the location information is held in the base. The address card simplifies and speeds up installation and commissioning. Addressing errors during maintenance and service are eliminated. XPlorer detectors read the lower six bits of the address card, giving a range of 1–63

The XPlorer manual call point, the Output Unit and the Switch Monitor use DIL switch addressing.

A range of compatible control equipment is available from many sources—details are available from Apollo.



Xplorer Optical Smoke Detector
Part Number 59000-605 (with standard base)
Part Number 59000-606 (with LED driver base)

Operating Principles

The Xplorer optical detector has a moulded self-extinguishing white polycarbonate case designed to allow free entry of smoke while minimising the effects of dust contamination. Stainless steel wiper contacts connect the monitor to the terminals in the mounting base. Within the case is a printed circuit board which on one side has the light proof labyrinth chamber with integral gauze surrounding the optical measuring system. The other side has the address capture, signal processing and communications electronics.

An infrared light emitting diode (IR LED) within the optical chamber is arranged at an obtuse angle to a photo-diode. The photo-diode has an integral daylight-blocking filter. The IR LED emits a burst of collimated light every second. In clear air the

photo-diode receives no light directly from the IR LED. When smoke enters the chamber it scatters light from the IR LED onto the photo-diode in an amount related to the smoke characteristics and density. The photo-diode signal is processed by the optical ASIC and passed to the A/D converter on the communications ASIC ready for transmission when the device is interrogated.

Electrical Description

The detector is designed to be connected to a two wire loop circuit carrying both data and a 17V to 28V DC supply. The detector is connected to the incoming and outgoing supply via terminals in the mounting base. Connection is polarity sensitive. (Figs 1a & 1b).

A remote LED driver base is also available. In addition to

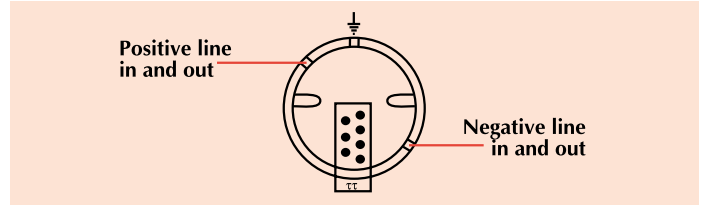

Fig.1a Xplorer standard base wiring

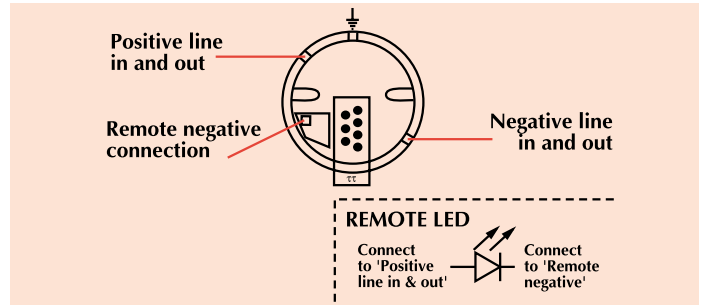

Fig.1b Xplorer LED driver base wiring

the supply terminals a connection for a remote LED is provided. The remote LED is connected between the positive supply line of the base and the remote negative terminal. The negative connection incorporates a 4k3 limiting resistor to protect the loop from accidental short circuit remote wiring. The LED current should be limited to 4mA.

When the device is energised the ASICs regulate the flow of power and control the data processing. The optical ASIC is controlled by the communications ASIC and pulses the IR LED. The signal from the photo-diode is

processed by the optical ASIC and transferred to the A/D converter in the communications ASIC where it is then stored. When smoke enters the chamber the photo-diode signal increases. The information to the A/D converter is updated once per second. Whenever the device is interrogated this data is sent to the control equipment.

The detector is calibrated to give an analogue value of 25 ± 7 counts in clean air. This value increases with smoke density. A count of 55 corresponds to the calibrated alarm threshold.

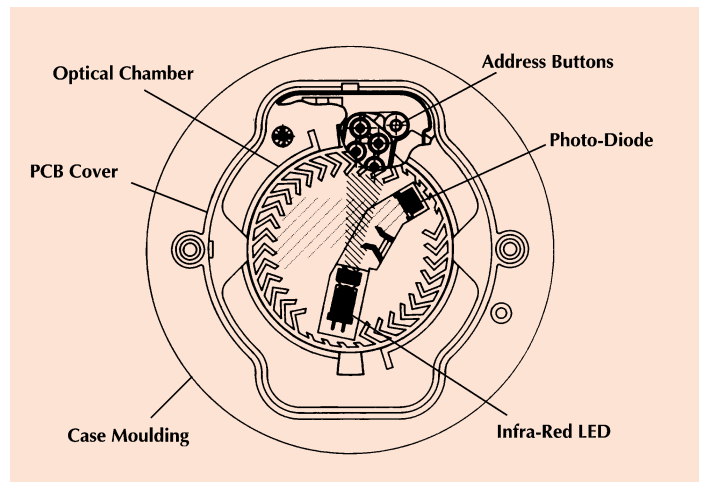

Fig.2 Top section - Xplorer Optical Smoke Detector

TECHNICAL DATA

XP95 Optical

Specifications are typical and given at 23°C and 50% relative humidity unless otherwise specified.

Address Range:

1–63 (6 bits)

Detector Type:

Products of combustion (smoke)

Detection Principle:

Photo-electric detection of light scattered in a forward direction by smoke particles

Chamber Configuration:

Horizontal optical bench housing an infrared emitter and sensor arranged radially to detect forward scattered light

Sensor:

Silicon PIN photo-diode

Emitter:

GaAlAs Infra-red light emitting diode

Sampling Frequency:

1 second

Supply Wiring:

Two wire supply, polarity sensitive

Detector Terminal Functions:

Supply positive and negative in and out connections (polarity sensitive). Remote indicator connection to LED driver base

Supply Voltage:

17 to 28 Volts dc

Quiescent Current:

340µA

Duration of Power-up Surge Current:

1 second

Maximum Power-up Time:

(measured from application of power and protocol)

4 seconds for communications

10 seconds to exceed 10 counts

35 seconds for stable clean air value

Storage Temperature:

-30°C to +80°C

Operating Temperature:

(No condensation or icing)

-20°C to +60°C

Clean Air Analogue Value:

25±7 counts

Alarm Level:

55 counts

Alarm Indicator:

Red light emitting diode (LED)

Alarm LED Current:

2mA

Remote LED Base Connection:

4.3kΩ connected to

negative line

Type Code:

(210 43) 101 00

Sensitivity:

Nominal threshold of 2.4% light grey smoke obscuration per metre

Humidity:

(No condensation)

0% to 95% relative humidity

Wind Speed:

Unaffected by wind

Atmospheric Pressure:

Insensitive to atmospheric pressure

Vibration, Impact & Shock:

To EN54–7:2000

Electro-magnetic

Compatibility:

CE marked.

A copy of the relevant declaration is available on request.

IP Rating:

43

Dimensions: (diameter x height)

Detector: 100mm x 39mm

Detector in Base:

100mm x 47 mm

Weights:

Detector: 100g

Detector in Base: 157g

Materials:

Detector Housing: White polycarbonate V-0 rated to UL 94

Terminals: Stainless Steel

Environmental Characteristics

The XPlorer optical smoke detector is unaffected by wind or atmospheric pressure and operates over the temperature range -20°C to +60°C.

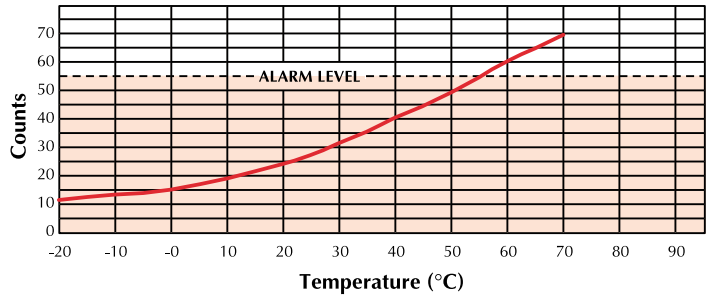

Fig.4a Standard Heat Detector

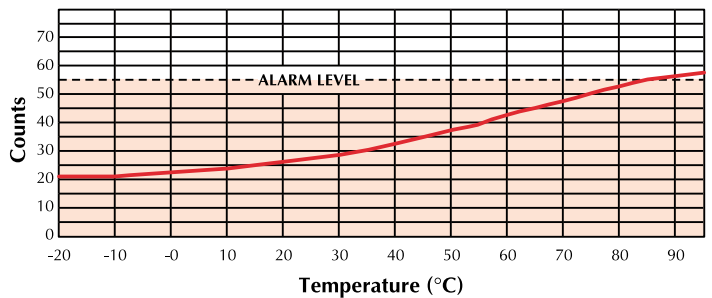

Fig.4b High Temperature Heat Detector

Xplorer Heat Detector
 Part Number 59000-405 (with standard base)
 Part Number 55000-406 (with LED driver base)

Operating Principles

The Xplorer heat detectors have a low air flow resistance case made of self-extinguishing white polycarbonate. The devices monitor temperature by using a single thermistor network which provides a voltage output proportional to the external air temperature.

The response to heat increases of the standard heat detectors, Part Nos 59000-405 and 59000-406, enables the detector to be

utilised as an EN54–5:2000 A2S heat detector, which is equivalent to an EN54–5:1984 Grade 2 detector. (Fig 4a).

A high temperature heat detector, Part No 59000-415 (with standard base) or 59000-416 (with LED driver base), which has similar characteristics at 25°C but reaches a 55 count at 90°C, is available for use in normal ambient temperatures of up to 55°C. This detector meets the requirements for a CS detector in EN54–5:2000. (Fig 4b).

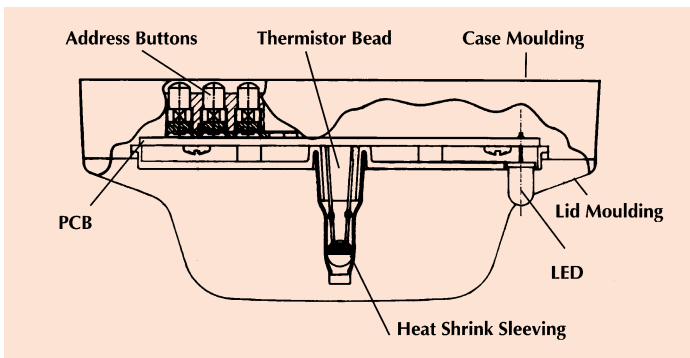

Fig.3 Xplorer Heat Detector

Electrical Description

The detector is designed to be connected to a two wire loop circuit carrying both data and a 17V to 28V DC supply. The detector is connected to the incoming and outgoing supply via terminals in the mounting base. Connection is polarity sensitive. (Fig 2a)

A remote LED driver base is also available. In addition to the supply terminals a connection for a remote LED is provided. The remote LED is connected between the positive supply line of the base and the remote negative terminal. The negative connection incorporates a 4.3kΩ limiting resistor to protect the loop from accidental short circuit remote wiring. The LED current should be limited to 4mA.

When a device is energised the ASIC regulates the flow of power and controls the data processing. The

thermistor provides an output over normal operating ranges that, in the case of the standard detector, is proportional to the external air temperature. This voltage output is processed in the A/D converter and stored by the communications ASIC. It is transmitted to control equipment when the device is interrogated. The detector is calibrated to give an analogue value of 25±5 counts at 25°C.

The high temperature heat detector operates in a very similar manner, but the 55 count alarm threshold indicates a temperature of 90°C.

Environmental Characteristics

Xplorer standard heat detectors operate over the range -20°C to +70°C. The high temperature heat detectors operate over the range -20°C to +120°C. The detectors are unaffected by atmospheric pressure.

TECHNICAL DATA

XPlorer Standard Heat Detector

Specifications are typical and given at 23°C and 50% relative humidity unless otherwise stated.

Address Range:
1–63 (6 bits)

Detector Type:
Fixed Temperature Heat

Detection Principle:
Temperature sensitive resistance

Sensor:
Single NTC Thermistor
Sampling Frequency:
Continuous

Sampling Frequency:
Continuous

Supply Wiring:
Two wire supply, polarity sensitive

Detector Terminal Functions:
Supply positive and negative in and out connections (polarity sensitive); remote indicator connection to LED driver base

Supply Voltage:
17 to 28 Volts DC

Quiescent Current:
300µA at 24V

Power-up Surge Current:
1mA

Duration of Power-up Surge Current:
1 second

Maximum Power-up Time:
4 seconds

Storage Temperature:
-30°C to +80°C

Min Continuous Operating Temperature:
-0°C

Min Operating Temperature (no condensation or icing):
-20°C

Application Temperature:
Class EN54–5:2000 A2S
typical 25°C, max 50°C

Static Response Temperature °C:

Min	Typ	Max
54	58	62

Alarm Level Analogue Value:
55

Alarm Indicator:
Red light emitting diode (LED)

Alarm LED Current:
2mA

Remote LED base connection:
4.3kΩ connected to negative line

Type Code:
(210 43) 110 00

Sensitivity:
25°C to 90°C: 1°C/Count
-20°C returns 8 counts

Humidity:
(No condensation or icing)
0% to 95% relative humidity

Wind Speed:
Unaffected

Atmospheric Pressure:
Unaffected

Vibration, Impact & Shock:
To EN54-5:2000

Electro-magnetic Compatibility:
CE marked.

A copy of the relevant declaration is available on request.

IP Rating:
53

Dimensions: (diameter x height)
Detector: 100mm x 39mm
Detector in Base:
100mm x 47mm

Weights:
Detector: 100g
Detector in Base: 157g

Materials:
Detector Housing: White polycarbonate V-0 rated to UL 94
Terminals: Stainless Steel

TECHNICAL DATA

XPlorer High Temperature Heat Detector

Specifications are the same as those for the standard temperature, apart from the following points:

Detector Principle:
Temperature sensitive resistance. Linear approximation designed to give 26 counts at 25°C and 55 counts at 90°C

Type Code:
(210 43) 110 01

Application Temperature:
Class EN54–5:2000 CS
typical 55°C, max 80°C

Static Response Temperature °C:

Min	Typ	Max
84	90	96

Sensitivity:
25°C to 90°C: 2.17°C/Count
-20°C returns 20 counts



Xplorer Manual Call Point (MCP)
Part Number 59000-910

Operating Principles

The Xplorer manual call point is designed for surface mounting and incorporates the call point assembly and a back box.

The address of each call point is set at the commissioning stage by means of a six-segment DIL switch, giving a range of addresses from 64 to 126.

A single alarm LED is provided on the call point.

This LED is controlled, independently of the call point, by the CIE. Call points can be remotely tested from the control and indicating equipment by transmission of a single bit in the communications protocol. Call points respond by providing a value of 64 which corresponds to the alarm value. The CIE will recognise this response as a test signal and will not raise a general alarm.

TECHNICAL DATA

Xplorer Manual Call Point

Specifications are typical and apply at temperature 23°C and relative humidity 50% unless otherwise stated.

Address Range:
64 to 126

Call Point Type:
Break Glass

Weight:
190g

Call Point Principle:
Operation of a switch

Alarm Indicator:
Red Light Emitting Diode (LED)

Type Code:
(2 1 0 4 3)
1 1 1 1 1

Supply Wiring:
Two-wire supply, polarity sensitive

Loop connections:
Flying leads with spade terminals

Operating Voltage:
17-28V DC

Quiescent Current:
270µA

Power-up Surge Current:
650µA

Maximum Power-up Time:
4 seconds

Alarm LED Current:
1mA

Normal Analogue Value:
16

Alarm Level Analogue Value:
64

Electro-magnetic Compatibility:
CE marked. A copy of the relevant declaration is available on request

Temperature Range:
Max. continuous operating: +60°C
Min. continuous operating: 0°C
Min. operating: -20°C (no condensation/icing)
Storage: -30°C to +80°C

Humidity:
0 to 95% relative humidity (no condensation)

Vibration, Impact and Shock:
To prEN54-11

IP Rating:
53

Dimensions:
87mm x 87mm x 52mm

Materials:
Housing: Red polycarbonate/ABS



Xplorer Output Unit
Part Number 59000-810

TECHNICAL DATA

Output Unit

Address Range:
64 to 126

Operating Voltage:
17–28V DC

Maximum current consumption at 24V:

switch-on surge,	3mA
max 100ms	
quiescent	720uA
relay operated	2mA

Relay output contact rating at 30V AC or DC, max:
1A (inductive or resistive)

Relay output wetting at 10mV DC:
10µA

Operating temperature:
–20°C to +70°C

Humidity(no condensation):
0–95%

**Shock
Vibration
Impact** } GEI 1 - 052

**Electro-magnetic
Compatibility:**
CE marked.
A copy of the relevant declaration is available on request.

Dimensions and weight of Output Unit:
65mm x 45mm x 22mm
31g

Operating Principles

The Xplorer Output Unit provides a voltage-free, single pole, change-over relay output. The change-over contact is operated by an output bit. The Output Unit returns an analogue value of 16 under all conditions.

Electrical Considerations

The Output Unit is loop powered. The loop connections are polarity sensitive

Protocol Bit Usage

The control equipment transmits a 10-bit message to the Output Unit:

The **output (or forward command) bits** from the control panel have the following function.

Output bits 2 and 1 are not used.

Output bit 0 controls the relay.

When **output bit 0** is set to logic 1 on two or more consecutive pollings, the relay changes state to the “set” condition. Bit 0 must be set to logic 1 as long as it is desired to keep the relay in its set state. The relay will remain latched in the set state until output bit 0 is set to logic 0

on two or more consecutive polls. Discontinuation of interrogation of its address will not affect the state – set or not – of the relay but removal of loop power will ‘reset’ the relay.

The **seven bits** which are then transmitted by the control panel correspond to the **address (as set on the lower 6 bits of the DIL switch with an internal preset high bit)** of the device to be polled. The 6 bits of the DIL switch give an addressable range of 64 to 126.

A response message is then sent by the Output Unit to the control equipment:

The **interrupt bit** is always set to logic ‘0’

The **analogue value bits** are sent to return a preset value of 16 under all conditions.

The **input bits** are not used by the Output Unit.

The **type bits** are used to identify the type of unit responding. The type code of the Output Unit is 01000 (bits 2,1,0,4,3 respectively).

The Output Unit sends **seven bits** of data to confirm its address.

The **alarm flag** is not placed by the Output Unit.

Mechanical Construction

The Output Unit is normally supplied with screws for surface mounting. It is designed for indoor use only.



Xplorer Isolator
Part Number 59000-700

Operating Principles

The Xplorer isolator senses and isolates short circuit faults on Xplorer loops. It is loop powered and polarity sensitive.

Power and signals to the affected section are restored automatically when the fault is cleared.

Electrical Description

Under normal operating conditions, a low resistance is present between the –L IN and –L OUT terminals of the isolator, so that power and signals pass to the next device in the line.

If a short circuit or abnormally low resistance occurs, the fall in voltage is sensed and the isolator isolates the negative supply in the direction of the fault.

The Xplorer incorporates the same isolating circuitry as other Apollo isolating devices. For more information on isolation principles please refer to PIN sheet PP2090, 'Short circuit isolation in XP95 and Discovery fire detection systems'.

TECHNICAL DATA

Xplorer Isolator

Minimum Loop Operating Voltage in normal conditions:
17V DC

Maximum Loop Operating Voltage:
28V DC

Maximum Loop Current:
1A continuous
3A switching

Maximum Load:
20 Xplorer detectors or equivalent

Operating Temperature:
–20°C to +60°C

Storage Temperature:
–30°C to +80°C

Operating Humidity:
0–95% RH, non-condensing

Xplorer Mounting Bases and XPERT Cards

The Xplorer detectors all fit the Xplorer mounting base and LED driver base. Cable connections of up to 2.5mm diameter are made via captive cable clamps.

There are three terminals on the standard mounting base and an additional two on the remote LED driver base.

Universal address cards, known as XPERT cards are supplied with all bases. Consult the coding guide supplied with the bases to determine which pips are to be removed.

The base has a 'one way only' fit and detectors can be locked into the base by a locking screw with the aid of a small cross-point screwdriver.

Maintenance of Detectors

Apollo Fire Detectors has published a guide to the care, maintenance and servicing of Apollo products, PP2055, which is available on request. This guide outlines the maintenance routines recommended for optimum detector performance and the services available from Apollo's factory-based Service Department.

Approvals

Xplorer smoke and heat detectors comply with EN54–7:2000 and EN54–5:2000 respectively. Detectors also comply with EMC Directive 89/336/EEC and are CE marked.

Each detector type is designed to be approved by approval and regulatory bodies worldwide, including LPCB in the UK.

Detectors and manual call point are LPCB approved.



Quality Systems Certificate No 010
Assessed to ISO 9001

