



Prestige® IAQ with Equipment Interface Module

Installation Guide



Search for local rebates: HoneywellHome.com/Rebates

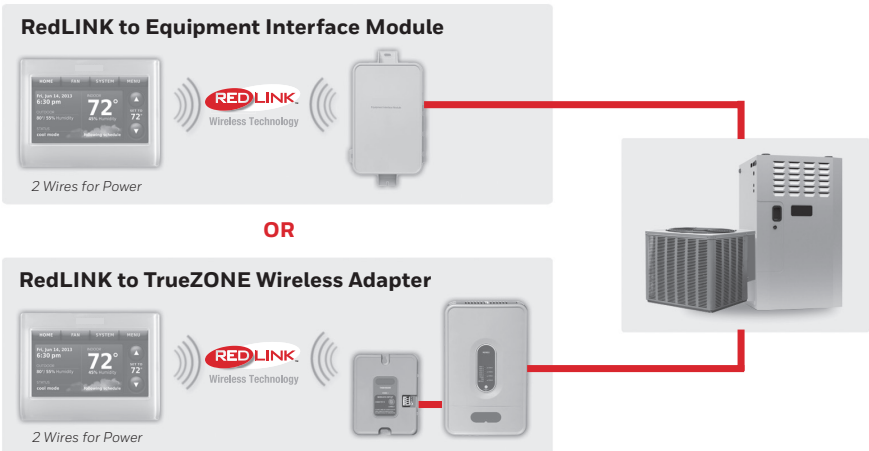

Reference to key features

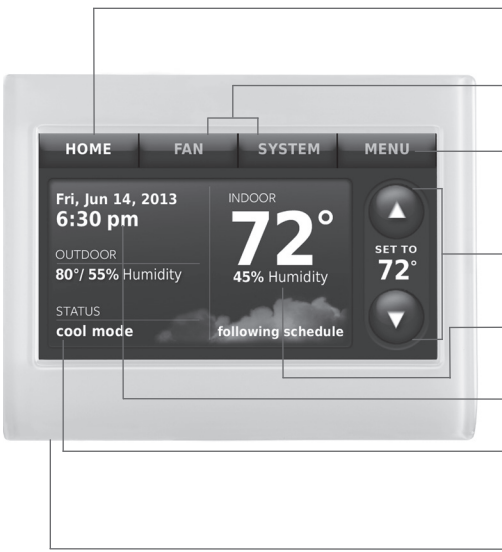

Current display. Button pressed in signifies current display

Mode control buttons. Use to change settings for Fan or System Heat/Cool.

Menu. Select options to: set schedules, view equipment status, change IAQ settings, access installer options*, etc.

Current schedule. Shows desired temperature and schedule status.

Indoor conditions. Shows indoor temperature and humidity.

Current date and time.

Current status. Shows system mode (heat/cool), outdoor temperature and humidity (with optional outdoor sensor).

USB port. Use USB device to load settings and dealer information.

* Password is date code.

Getting started

Follow these basic steps to install this thermostat, link it with the equipment interface module (EIM) and wireless accessories and set installer options.

- 1 Installing the Equipment Interface Module (EIM)
- 2 Installing the thermostat
- 3 Powering optional RedLINK 2.0 accessories
- 4 Performing initial setup
- 5 Finding your password (Date Code)
 - To add or remove RedLINK 2.0 accessories
 - To make changes to Installer Setup
 - To perform an Installer Test
 - To view Data Logs

Thermostat (back view)

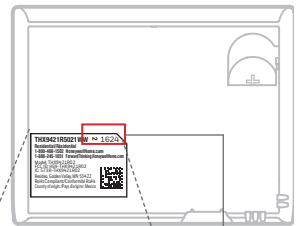

Password (Date Code)



1 Installing the equipment interface module (EIM)

NOTE: If an EIM is mounted inside a metal cabinet, it is recommended to use a THM4000R1000 Wireless Adapter for extended wireless range. Mount the Wireless Adapter outside the metal cabinet and connect to the ABCD terminals at the EIM.

NOTE: When installing multiple thermostats and EIMs, mount the EIMs at least 2 feet apart for best RedLINK 2.0 performance.

1.1 Mount EIM.

Mount the EIM near the HVAC equipment or on the equipment itself.

Use screws and anchors as appropriate for the mounting surface.

1.2 Wire EIM as shown.

Refer to the table and wiring diagrams on pages 3-5.

NOTE: If you are installing discharge and return air sensors, refer to the mounting instructions in the Alerts and Delta T Diagnostics Installation Instructions packed in the kit.

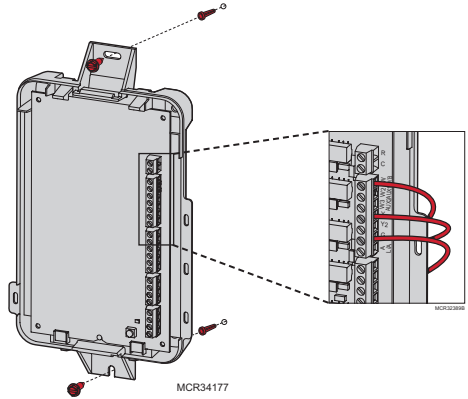

Terminal Designations

Conventional System		Heat Pump	
Terminal	Description	Terminal	Description
C	Common wire from 24 VAC transformer.	C	Common wire from 24 VAC transformer.
R*	Power wire from 24 VAC transformer.	R	Power wire from 24 VAC transformer.
RH*	Heating power.	RH	Heating power.
RC*	Cooling power.	RC	Cooling power.
W	Heat Stage 1	O/B	Changeover valve for heat pumps.
W2	Heat Stage 2	AUX 1	Backup Heat Stage 1/Emergency Heat Stage 1
W3	Heat Stage 3	AUX 2	Backup Heat Stage 2/Emergency Heat Stage 2
Y	Compressor Stage 1	Y	Compressor Stage 1
Y2	Compressor Stage 2	Y2	Compressor Stage 2
G	Fan Relay	G	Fan Relay
A	Connect to Economizer Module or Lighting Panel (TOD).	L/A	Connect to Compressor Monitor, Zone Panel, Economizer Module or Lighting Panel (TOD).

* Remove jumpers when separate transformers are used.

Terminal Designations

Conventional System		Heat Pump	
Terminal	Description	Terminal	Description
U1 / U1** U2 / U2** U3 / U3**	Relay for humidification, dehumidification, ventilation, or a stage of heating/cooling. U terminals are dry contacts that require power.	U1 / U1** U2 / U2** U3 / U3**	Relay for humidification, dehumidification, ventilation, or a stage of heating/cooling. U terminals are dry contacts that require power.
S1 / S1*** S2 / S2*** S3 / S3*** S4 / S4***	Input for a wired indoor sensor, outdoor sensor, discharge sensor, return sensor, dry contact device for alerts or dry contact device for remote setback.	S1 / S1*** S2 / S2*** S3 / S3*** S4 / S4***	Input for a wired indoor sensor, outdoor sensor, discharge sensor, return sensor, dry contact device for alerts or dry contact device for remote setback.
A B C D	Connect to THM4000R1000 Wireless Adapter for extended wireless range.	A B C D	Connect to THM4000R1000 Wireless Adapter for extended wireless range.

** See wiring diagrams on pages 4-5.

*** See wiring diagram below for wiring Dry Contact Devices to display alerts.

Wiring dry contact devices to display alerts



DISCONNECT POWER BEFORE INSTALLATION.

Do not apply power to S1, S2, S3 or S4 terminals.



NOTE: The dry contact device must be rated for low voltage.

Connect a dry contact device such as a water sensor to S1, S2, S3 or S4 terminals. The thermostat displays an alert when a problem is detected.

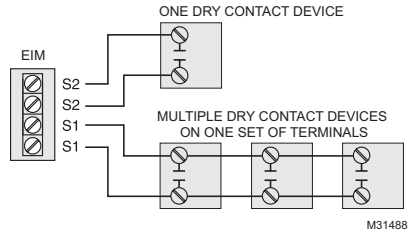

Connecting a stage of heating or cooling to a relay (U1, U2, U3)

- 1 U1, U2, and U3 are normally open dry contacts when set up for a stage of heating or cooling.
- 2 You must install a field jumper if the stage of heating or cooling is powered by the system transformer. Do NOT install a field jumper if the stage of heating has its own transformer.

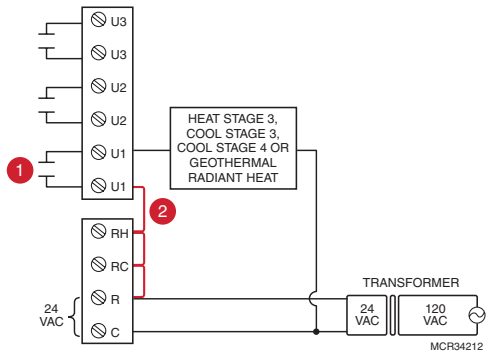

Wiring humidification, dehumidification and ventilation

Typical hookup of powered humidifier

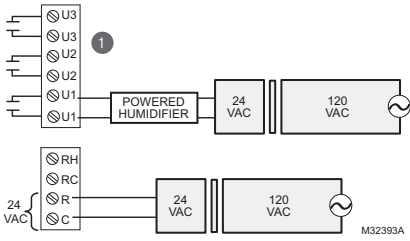

Typical hookup of non-powered humidifier

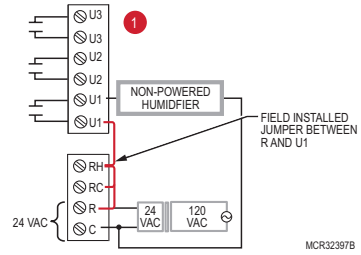

Typical hookup of powered ventilation

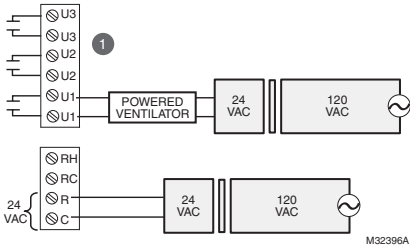

Typical hookup of non-powered ventilation

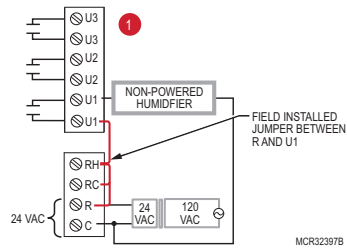

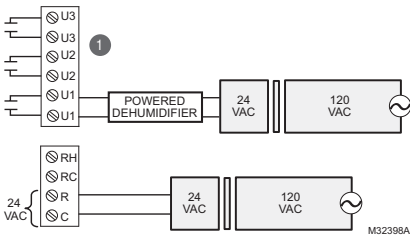

Typical hookup of powered dehumidifier (whole house dehumidifier)

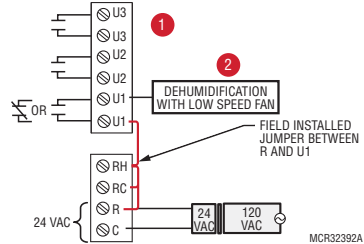

Typical hookup of variable speed blower for dehumidification in low speed



- 1 Any combination of relays (U1, U2, U3) can be used. They are set in the thermostat installer setup.
- 2 Wire the EIM relay to the low speed fan for dehumidification control at the equipment. The EIM relay can be set to be normally open or normally closed in the thermostat installer setup.

-  Normally open, dry contacts
-  Normally closed, dry contacts

2 Installing the thermostat

2.1 Separate wallplate from thermostat.

Thermostat (back view)

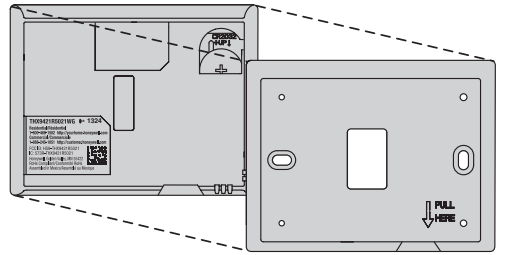

Wallplate (back view) MCR34203

2.2 Mount wallplate as shown.

Mount new wallplate using screws and anchors included with the thermostat.

Drill 3/16-in holes for drywall.

Drill 7/32-in holes for plaster.

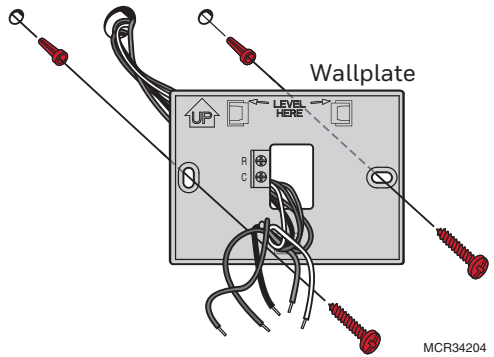

MCR34204

2.3 Connect power to thermostat.

2.3a Connect thermostat to the R and C terminals at the EIM or to a separate 24 volt transformer (not provided).

2.3b Push excess wire back into the wall opening.

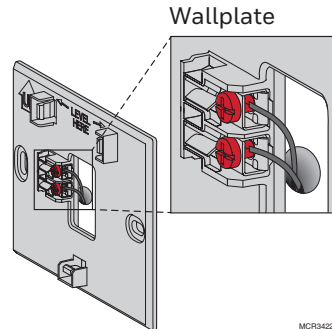

MCR34222

2.4 Insert coin cell battery.

Place coin cell battery in thermostat as shown with + side up.



NOTE: Coin cell battery saves time and date during a power loss.

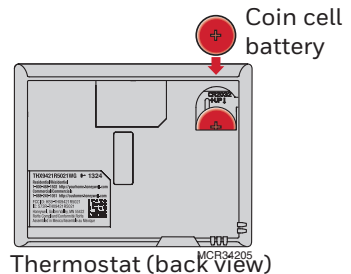

Thermostat (back view) MCR34205

2.5 Mount thermostat on wallplate.

Align thermostat to wallplate and snap into place.

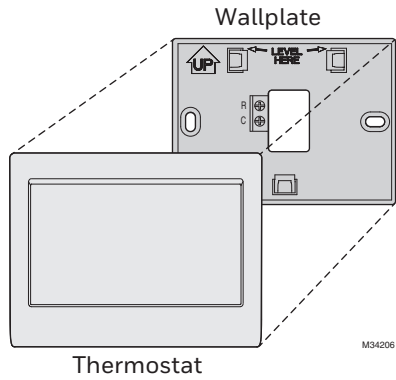

3 Powering optional RedLINK 2.0 accessories

3.1 Install batteries in RedLINK 2.0 accessories.

- Portable Comfort Control*
- Wireless Outdoor Sensor*
- Wireless Indoor Sensor*
- Wireless Entry/Exit Remote*
- Wireless Vent and Filter Boost Remote*

* Requires setup. See Installer Setup options in Step 4.5.

3.2 Connect gateway to internet and connect to power.

3.2a Connect RedLINK 2.0 Internet Gateway to router or modem with Ethernet cable (RJ45).

3.2b Connect gateway's power cord to an electrical outlet that is not controlled by a wall switch.

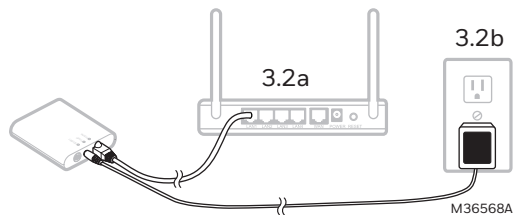

4 Performing initial setup

Initial setup options define the type of system you are installing:

- Residential or commercial
- Non-zoned or zoned
- Used with or without an Equipment Interface Module (THM5421)
- Used with or without the TrueZONE Wireless Adapter (THM4000)

4.1 Follow prompts on the screen to select appropriate options.

 **NOTE:** If you are connecting the thermostat to the TrueZONE Wireless Adapter (THM4000), refer to the TrueZONE instructions to link the thermostat and RedLINK 2.0 accessories. Then go to step 4.5.



4.2 Link the thermostat to the equipment interface module.

4.2a **Press and quickly release** the CONNECT button on the EIM. Make sure the “Connected” light is flashing green.

 **NOTE:** If the “Connected” light does NOT flash green, another system may be in the listening mode. Please exit the listening mode at the other system and then try again.

- Green Flashing: In Listening Mode - system is ready to add RedLINK 2.0 devices.
- Green Steady: RedLINK 2.0 devices are communicating.
- Red: RedLINK 2.0 device(s) are NOT communicating. Check EIM and RedLINK 2.0 devices.

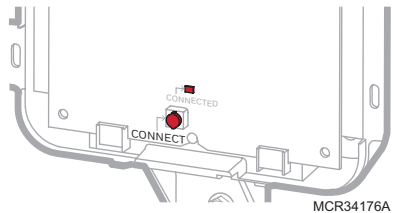

4.2b While the “Connected” light is flashing green on the EIM, press **Next** on the thermostat. After a short delay, the screen will display Device Connected.



4.3 When you see the prompt Do you have RedLINK 2.0 accessories to connect? Touch Yes or No.

- If you select **Yes**, you will be prompted to Press Connect on all new accessories. Continue to Step 4.4.
- If you select **No**, continue to Step 4.5.



4.4 Connect each RedLINK 2.0 accessory.

 **NOTE:** Make sure accessories are at least 2 feet away from the EIM during the linking process.

4.4a While the Add Device screen is displayed (listening mode), **press and quickly release** the CONNECT button on each new RedLINK 2.0 accessory.

4.4b After a short delay (up to 20 seconds), check the thermostat to confirm the connection of each RedLINK 2.0 accessory.

4.4c Touch **Done** at the thermostat after all new RedLINK 2.0 accessories are connected.

 **NOTE:** The thermostat displays a countdown timer while in listening mode. If it detects no activity for 15 minutes, it exits listening mode.

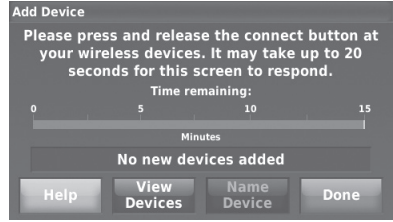

Listening mode



Listening mode

4.5 Finish the initial setup.

Finish the setup by selecting the desired options. Touch **Done** after you select the last option you want to change.

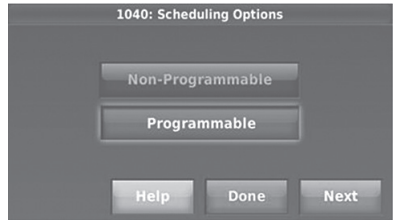

The thermostat now displays its Home screen and the **thermostat setup is complete.**



5

Finding your password (Date Code)

- To add or remove RedLINK 2.0 accessories
- To make changes to Installer Setup
- To perform Installer Test
- To view Data Logs

Finding your password

You can find the Date Code on the back of the thermostat, or

1 Touch **Menu**.

2 Select **Dealer Information**.

Thermostat (back view)

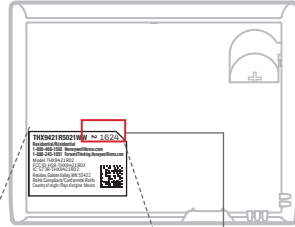

Password
(Date Code)

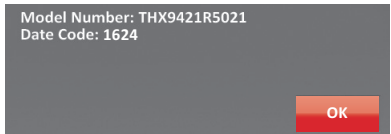
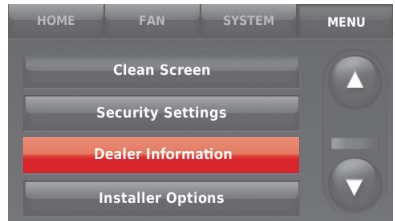

Linking RedLINK 2.0 accessories to the thermostat

- 1 Touch **Menu**.
- 2 Select **Installer Options**.
- 3 Enter password (date code) and touch **Done**.

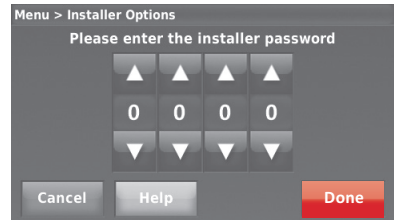
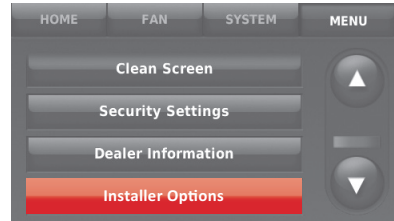

- 4 Select **Wireless Device Manager**.

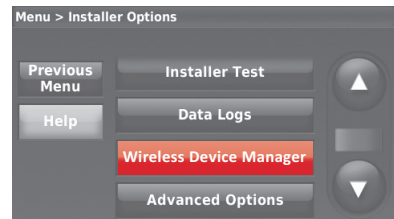

- 5 Select **Add Device** to display the Add Device screen. The thermostat is now in listening mode.

 **NOTE:** Accessories must be at least 2 feet away from the EIM during the linking process.

- 5a **Press and quickly release** the **CONNECT** button on each new RedLINK 2.0 accessory.

- 5b After a short delay (up to 20 seconds), check thermostat to confirm the connection of each RedLINK 2.0 accessory.

- 5c Touch **Done** at the thermostat after all new RedLINK 2.0 accessories are connected.

 **NOTE:** Thermostat displays a countdown timer while in listening mode. If it detects no activity for 15 minutes, it exits listening mode.

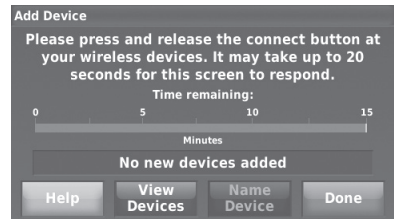
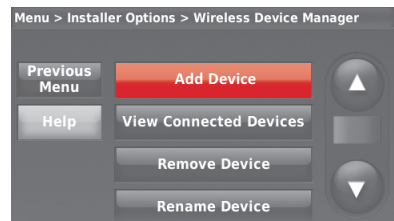

Listening mode



Listening mode

Making changes to Installer Setup and performing Installer Test

Follow these steps to set system options after initial installation.

 **NOTE:** Use a USB device to save set up time. See page 14.

- 1 Touch **Menu**.
- 2 Select **Installer Options**.
- 3 Enter password (date code) and touch **Done**.
- 4 Select **Create Setup** or **Installer Test**.
- 5 Follow prompts on the screen to select the desired setup options or to perform an equipment test.

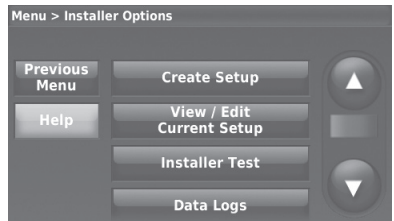
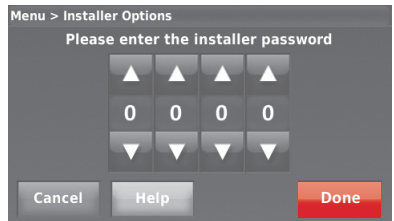
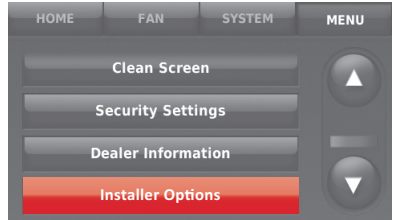

Mounting outdoor and indoor sensors

Mounting an outdoor sensor

- 1 Mount the sensor on a vertical exterior wall, at least 6 inches below any overhang. Choose a location protected from direct sunlight.
- 2 Place sensor securely in bracket, facing away from wall.

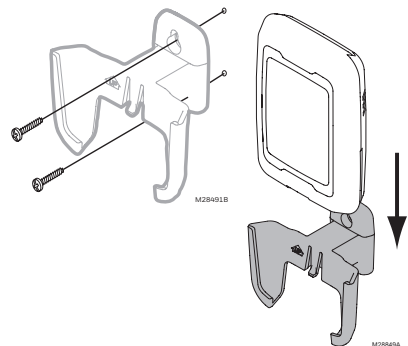

Mounting an indoor sensor

- 1 Remove the wallplate and mount it 4 to 6 feet above the floor on an interior wall. Drill 3/16-inch holes for drywall, 7/32-inch for plaster.
- 2 Attach sensor securely to wallplate as shown.

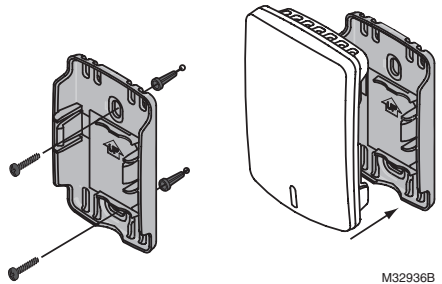

Indoor sensor operation

Temperature control

The thermostat can be set to respond to its internal temperature sensor, or to an optional remote indoor sensor. If multiple sensors are selected, the thermostat will respond to an average of temperatures detected at each sensor.

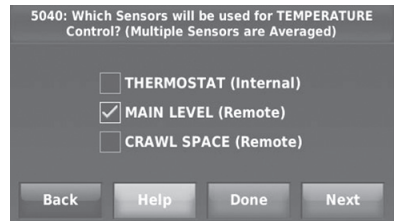

Humidification control

If optional remote indoor sensors are installed, you can choose which sensor you want to use for humidification control. You can use a different sensor for dehumidification.

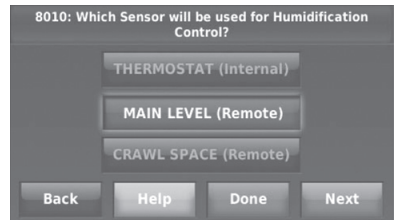

Dehumidification control

If optional remote indoor sensors are installed, you can choose which sensor you want to use for dehumidification control. For example, you can use one sensor for humidification control, and another for dehumidification.



Using a USB device for setup, data logs and software upgrades

 **NOTE:** Modern USBs with over 8 MB may have compatibility issues.

Use a USB device to save set up time by loading Installer Setup settings, Dealer Information, Holiday Schedules, and Custom Reminders to multiple thermostats. For troubleshooting help, you can save the thermostat Data Logs (Alerts Log, User Interactions Log and Performance Logs) to a USB device - then view them on your computer. Also use the USB device to upgrade the thermostat software.

- Visit <https://www.resideo.com/us/en/pro/thermostat-setup/> to enter your dealer information and contractor logo or load new thermostat software.
- After setup is complete, save Installer Setup, Holiday Schedules, and Custom Reminders to USB device.

To use the USB device in the thermostat:

- 1 Slide USB device into the bottom of thermostat.
- 2 Select the item to load or save.
- 3 Follow the prompts on the screen for the item you selected.
 - To add information from the USB device to the thermostat, select **Load into Thermostat**.
 - To put thermostat information on the USB device, select **Save to USB**.

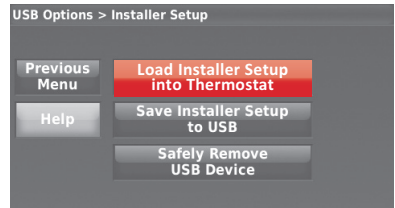
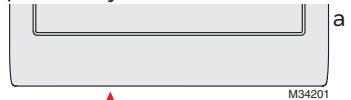

To replace a thermostat

When you replace a thermostat, you must reset the RedLINK 2.0 accessories before connecting them to the new thermostat. Follow the instructions below.

At the Portable Comfort Control:

Press and hold the blank space (or arrow) in the lower right corner of the screen until the display changes (hold for about 4 seconds). Press REMOVE, then YES to disconnect the old thermostats. To reconnect the thermostat, go to Step 4.3.

At the Indoor Sensor, RedLINK 2.0 Internet Gateway, Entry/Exit Remote, Vent-Filter Boost Remote or TrueSteam Wireless Adapter:

Press and hold the CONNECT button on the accessory until the status light glows amber (hold for about 10 seconds). To reconnect the thermostat, go to Step 4.3.

At the Equipment Interface Module (EIM):

Press and hold the CONNECT button on the EIM until the CONNECTED LED glows amber (hold for about 10 seconds). Follow the prompts on the screen to connect the new thermostat to the EIM. To reconnect the thermostat, go to Step 4.2.

Portable Comfort Control

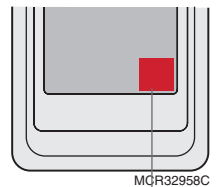

Press and hold

Specifications and replacement parts

Operating Ambient Temperature

- Thermostat:** 32 to 120° F (0 to 48.9° C)
- Portable Comfort Control:** 32 to 120° F (0 to 48.9° C)
- Wireless Outdoor Sensor:** -40 to 140° F (-40 to 60° C)
- Wireless Indoor Sensor:** 0 to 120° F (-17.8 to 48.9° C)
-For Optimal Battery Life: 35 to 114° F (1.7 to 45.6° C)
- Equipment Interface Module:** -40 to 165° F (-40 to 73.9° C)
- Return Air Sensor:** 0 to 200° F (-17.8 to 93.3° C)
- Discharge Air Sensor:** 0 to 200° F (-17.8 to 93.3° C)
- RedLINK 2.0 Internet Gateway:** 32 to 120° F (0 to 48.9° C)

Operating Relative Humidity

- Thermostat:** 5% to 90% (non-condensing)
- Portable Comfort Control:** 5% to 90% (non-condensing)
- Wireless Outdoor Sensor:** 0% to 100% (condensing)
- Wireless Indoor Sensor:** 5% to 90% (non-condensing)
- Equipment Interface Module:** 5% to 95% (non-condensing)
- RedLINK 2.0 Internet Gateway:** 5% to 95% (non-condensing)

Physical Dimensions (height, width, depth)

- Thermostat:** 4-1/2 x 3-1/2 x 7/8 inches (115 mm x 88 mm x 22 mm)
- Equipment Interface Module:** 9-5/16 x 4-13/16 x 1-19/32 inches (91 x 147 x 42 mm)
- Wireless Outdoor Sensor:** 5 x 3-1/2 x 1-11/16 inches (127 x 89 x 43 mm)
- Wireless Indoor Sensor:** 2-7/8 x 1-7/8 x 15/16 inches (74 x 48 x 24 mm)
- Portable Comfort Control:** 6-1/4 x 3-1/8 x 1-5/8 inches (158 x 80 x 38 mm)
- RedLINK 2.0 Internet Gateway:** 3-7/8 x 3-9/16 x 1-1/8 (99 x 91 x 29 mm)

RedLINK 2.0 Communication

- Frequency:** 900 Mhz frequency range
- Re-Sync Time:** RedLINK devices re-establish communication within 6 minutes after AC power resumes.

Electrical ratings

Terminal	Voltage (50/60 Hz)	Max. Current Rating
W - OB	18 to 30 VAC and 750 mVDC	1.00A
Y (cooling)	18 to 30 VAC	1.00A
G (fan)	18 to 30 VAC	0.50A
W2 - Aux 1 (heating)	18 to 30 VAC	0.60A
W3 - Aux 2	18 to 30 VAC	0.60A
Y2 (cooling)	18 to 30 VAC	0.60A
A-L/A (output)	18 to 30 VAC	1.00A
U1	30 VAC max.	0.50A
U2	30 VAC max.	0.50A
U3	30 VAC max.	0.50A

Accessories and replacement parts

Accessories / Replacement Parts	Part Number
Equipment Interface Module	THM5421R1021
Wireless Adapter for TrueZone, TrueSteam, or extend wireless range of EIM	THM4000R1000
RedLINK Internet Gateway	THM6000R7001
Wireless Entry/Exit Remote	REM1000R1003
Wireless Vent and Filter Boost Remote	HVC20A1000
Portable Comfort Control	REM5000R1001
Wireless Outdoor Sensor	C7089R1013
Wireless Indoor Sensor	C7189R1004
Wired Outdoor Sensor 10k ohm NTC	C7089U1006
Wired Wall-mount Indoor Sensor 10k ohm NTC	C7189U1005
Supply or Return Air Sensor 10k ohm NTC	C7735A1000
Occupancy Sensor for Remote Setback	WSK-24
Cover Plate (covers marks left by old thermostats)	THP2400A1027W

 **DISCONNECT POWER BEFORE INSTALLATION.** Can cause electrical shock or equipment damage.

 **This thermostat contains a Lithium battery which may contain Perchlorate material.** Perchlorate Material—special handling may apply.
See www.dtsc.ca.gov/hazardouswaste/perchlorate

 **CAUTION: MERCURY NOTICE:** If this product is replacing a control that contains mercury in a sealed tube, do not place the old control in the trash. Contact your local waste management authority for instructions regarding recycling and proper disposal.

 **CAUTION: ELECTRONIC WASTE NOTICE:** The product and batteries should not be disposed of with other household waste. Check for the nearest authorized collection centers or authorized recyclers. The correct disposal of end-of-life equipment will help prevent negative consequences for the environment and human health.



Must be installed by a trained, experience technician. Read these instructions carefully. Failure to follow these instructions can damage the product or cause a hazardous condition.

Need Help?

For assistance please visit
<http://customer.resideo.com>,
or call toll-free:
800-468-1502



Scan for more information



resideo

www.resideo.com



Wireless Technology

Resideo Inc., 1985 Douglas Drive North
Golden Valley, MN 55422

69-2739-09 SA Rev. 05-23 | Printed in United States

©2023 Resideo Technologies, Inc.
This product is manufactured by Resideo Technologies, Inc., Golden Valley, MN, 1-855-733-5465.
The Honeywell Home trademark is used under license from Honeywell International Inc. All rights reserved.



69-2739-09